

DESIGN OF
WOOD AIRCRAFT
STRUCTURES

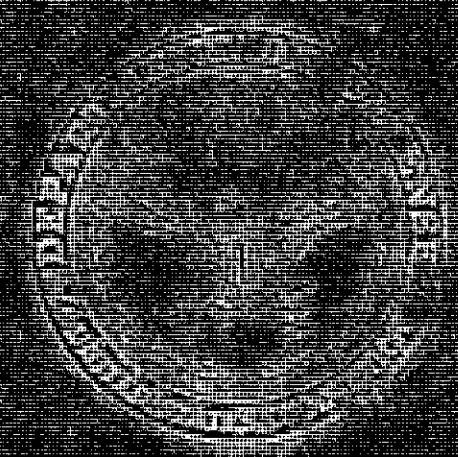

NATIONAL ADVISORY
COMMITTEE FOR AERONAUTICS

CONTENTS

	Page
CHAPTER 1. GENERAL	
1.0. PURPOSE AND USE OF BULLETIN.....	1
1.00. Introduction.....	1
1.01. Scope of Bulletin.....	1
1.02. Acknowledgments.....	1
1.1. NOMENCLATURE.....	1
1.10. Definitions for Plywood Elements--Beams, Prisms, and Columns in Compression, Strips in Tension..	1
1.11. Definitions for Plywood Panels.....	1
1.12. Standard Structural Symbols for Chapter 2.....	2
CHAPTER 2. STRENGTH OF WOOD AND PLYWOOD ELEMENTS	
2.0. PHYSICAL CHARACTERISTICS AND FACTORS AFFECTING THE STRENGTH OF WOOD.....	9
2.00. Anisotropy of Wood.....	9
2.01. Density or Apparent Specific Gravity.....	9
2.02. Moisture Content.....	9
2.03. Shrinkage.....	11
2.04. Temperature.....	12
2.05. Fatigue Properties.....	14
2.06. Plastic Properties.....	14
2.07. Impact Properties.....	14
2.08. Effect of Liquids.....	15
2.09. Miscellaneous Physical Properties.....	15
2.091. Coefficient of Expansion.....	15
2.092. Thermal Conductivity.....	17
2.093. Ignition Temperature.....	18
2.094. Electrical Properties.....	18
2.095. Damping Capacity.....	18
2.1. BASIC STRENGTH AND ELASTIC PROPERTIES OF WOOD.....	20
2.10. Design Values, Tables 2-6 and 2-7.....	20
2.100. Supplemental Notes.....	20
2.1000. Compression Perpendicular to Grain.....	20
2.1001. Compression Parallel to Grain.....	20
2.11. Notes on the Use of Values in Tables 2-6 and 2-7.....	20
2.110. Relation of Design Values in Tables 2-6 and 2-7 to Slope of Grain.....	20
2.111. Tension Parallel to Grain.....	27
2.112. Tension Perpendicular to Grain.....	27
2.12. Standard Test Procedures.....	27
2.120. Static Bending.....	27
2.1200. Modulus of Elasticity (E_L).....	27
2.1201. Fiber Stress at Proportional Limit (F_{bp}).....	27
2.1202. Modulus of Rupture (F_{bu}).....	28
2.1203. Work to Maximum Load.....	28
2.121. Compression Parallel to Grain.....	28
2.1210. Modulus of Elasticity (E_{Lc}).....	28
2.1211. Fiber Stress at Proportional Limit (F_{cp}).....	29
2.1212. Maximum Crushing Strength (F_{cu}).....	29
2.122. Compression Perpendicular to Grain.....	29
2.123. Shear Parallel to Grain (F_{su}).....	29
2.124. Hardness.....	29
2.125. Tension Perpendicular to Grain (F_{tuT}).....	31
2.13. Elastic Properties Not Included in Tables 2-6 and 2-7.....	31

2.130. Moduli of Elasticity Perpendicular to Grain (E_T, E_R).....	31
2.131. Moduli of Rigidity (G_{LT}, G_{LR}, G_{RT}).....	31
2.132. Poisson's Ratios (μ).....	31
2.14. Stress-strain Relations.....	31
2.15. Strength Under Multiaxial Stress.....	31
2.16. Stress Concentrations.....	32
2.161. Stress Concentrations Around a Hole in a Tension or Compression Member.....	32
2.162. Stress Concentrations Due to a Hole Which is Not Small Compared to the Size of the Member.....	34
2.2. COLUMNS.....	34
2.20. Primary Failure.....	34
2.21. Local Buckling and Twisting Failure.....	34
2.22. Lateral Buckling.....	34
2.3. BEAMS.....	36
2.30. Form Factors.....	36
2.31. Torsional Instability.....	36
2.32. Combined Loadings.....	36
2.320. General.....	36
2.321. Bending and Compression.....	36
2.322. Bending and Tension.....	40
2.33. Shear Webs.....	40
2.34. Beam Section Efficiency.....	40
2.4. TORSION.....	41
2.40. General.....	41
2.41. Torsional Properties.....	41
2.5. BASIC STRENGTH AND ELASTIC PROPERTIES OF PLYWOOD.....	41
2.50. General.....	41
2.51. Analysis of Plywood Strength Properties.....	42
2.52. Basic Formulas.....	42
2.53. Approximate Methods for Calculating Plywood Strengths.....	45
2.54. Moisture-strength Relations for Plywood.....	45
2.540. General.....	45
2.541. Approximate Methods for Making Moisture Corrections for Plywood Strength Properties.....	47
2.5410. Moisture Corrections for Plywood Compressive Strength (0° or 90° to Face Grain Direction).....	47
2.5411. Moisture Correction for Plywood Tensile Strength (0° or 90° to Face Grain Direction).....	47
2.5412. Moisture Corrections for Plywood Shear Strength (0° or 90° to Face Grain Direction).....	47
2.5413. Moisture Corrections for Plywood Compressive Strength (Any Angle to Face Grain Direction).....	47
2.5414. Moisture Corrections for Plywood Tensile Strength (Any Angle to Face Grain Direction).....	47
2.5415. Moisture Corrections for Plywood Shear Strength (Any Angle to Face Grain Direction).....	47
2.55. Specific Gravity-strength Relations for Plywood.....	47
2.56. Stress-strain Relations for Wood and Plywood.....	55
2.560. Mohr's Stress-and-strain Circles.....	59
2.5600. Obtaining Strains from Given Stresses.....	59
2.5601. Obtaining Stresses from Given Strains.....	59
2.5602. Experimental Stress-strain Data.....	59
2.57. Stress Concentrations (See Sec. 2.16 to 2.162).....	59
2.6. PLYWOOD STRUCTURAL ELEMENTS.....	59
2.60. Elements ($\theta=0^\circ$ or 90°).....	59
2.600. Elements in Compression ($\theta=0^\circ$ or 90°).....	60
2.601. Elements in Tension ($\theta=0^\circ$ or 90°).....	61
2.602. Elements in Shear ($\theta=0^\circ$ or 90°).....	61
2.61. Elements (θ =Any Angle).....	61
2.610. Elements in Compression (θ = Any Angle).....	61
2.611. Elements in Tension (θ =Any Angle).....	64
2.612. Elements in Shear (θ =Any Angle).....	64
2.613. Elements in Combined Compression (or Tension) and Shear (θ =Any Angle).....	64
2.614. Elements in Bending.....	65
2.6140. Deflections.....	66
2.615. Elements as Columns.....	67
2.7. FLAT RECTANGULAR PLYWOOD PANELS.....	67
2.71. Buckling Criteria.....	67
2.711. General.....	67
2.712. Compression ($\beta=0^\circ$ or 90°).....	68

	Page
2.713. Shear ($\beta=0^\circ$ or 90°).....	69
2.714. Combined Compression and Shear ($\beta=0^\circ$ or 90°).....	69
2.715. Compression, Shear, and Combined Compression and Shear (β =Any Angle).....	69
2.7151. Combined Compression (or Tension) and Shear.....	82
2.72. Strength After Buckling.....	92
2.721. General.....	92
2.722. Compression (β =Any Angle).....	92
2.723. Shear ($\beta=0^\circ$, 45° , or 90°).....	92
2.73. Allowable Shear in Plywood Webs.....	92
2.730. General.....	92
2.731. Allowable Shear Stresses.....	96
2.732. Buckling of Plywood Shear Webs.....	96
2.74. Lightening Holes.....	96
2.75. Torsional Strength and Rigidity of Box Spars.....	96
2.76. Plywood Panels under Normal Loads.....	96
2.760. General.....	96
2.761. Small Deflections.....	96
2.762. Large Deflections.....	98
2.77. Stiffened Flat Plywood Panels.....	98
2.771. The Stiffness of a Stiffener Affixed to a Plywood Panel.....	98
2.772. A Single Stiffener Bisecting a Panel.....	99
2.7721. Stiffened Panel Subjected to Edgewise Compression, Stiffener Perpendicular to the Direction of the Stress and Parallel to Side <i>A</i> ($\beta=0^\circ$ or 90°).....	99
2.7722. Stiffened Panel Subjected to Edgewise Compression, Stiffener Perpendicular to the Direction of the Stress ($\beta=45^\circ$).....	101
2.7723. Stiffened Panel Subjected to Edgewise Compression, Stiffener Parallel to the Direction of the Stress and to Side <i>B</i> ($\beta=0^\circ$ or 90°).....	101
2.7724. Stiffened Panel Subjected to Edgewise Compression, Stiffener Parallel to the Direction of the Stress ($\beta=45^\circ$).....	101
2.7725. Stiffened Panel Subjected to Edgewise Shear Stiffener Parallel to Edges (or Ends) of Panel and $\beta=0^\circ$ or 90°	101
2.773. A Plywood Panel Stiffened with A multiplicity of Closely Spaced Stiffeners Parallel to One of Its Edges ($\beta=0^\circ$ or 90°).....	101
2.7731. Determination of D_{wz}	103
2.7732. Determination of D_{xz}	103
2.7733. Determination of D_{wxz}	103
2.7734. Determination of μ_{fzwx}	103
2.774. Stiffened Plywood Panels Subjected to Bending in the Direction of the Stiffeners.....	103
2.775. Modes of Failure in Stiffened Panels.....	107
2.8. CURVED PLYWOOD PANELS.....	107
2.81. Strength in Compression or Shear; or Combined Compression (or Tension) and Shear.....	107
2.82. Circular Thin-walled Plywood Cylinders.....	107
2.821. Axial Compression.....	107
2.8211. Compression with Face Grain Parallel or Perpendicular to the Axis of the Cylinder.....	107
2.8212. Compression with 45° Face Grain.....	109
2.8213. Compression—Effect of Length.....	109
2.822. Bending.....	109
2.823. Torsion.....	109
2.824. Combined Torsion and Bending.....	109
2.83. Curved Panels.....	109
2.831. Axial Compression.....	109
2.832. Shear.....	109
2.84. Longitudinally Stiffened Cylinders.....	109
2.841. Stresses When Buckling Does Not Occur.....	109
2.8411. Axial Compression (or Tension).....	109
2.8412. Shear Stress Due to Torsion.....	111
2.842. Buckling of Stiffened Cylinders.....	112
2.8421. Axial Compression.....	112
2.8422. Torsion.....	112
2.8423. Bending.....	112
2.85. Stiffened Curved Panels.....	112
2.851. Axial Compression.....	112

2.8511. Stiffener Axial.....	112
2.8512. Stiffener Circumferential.....	112
2.852. Shear.....	116
2.8521. Stiffener Axial.....	116
2.9. JOINTS.....	116
2.90. Bolted Joints.....	116
2.900. Bearing Parallel or Perpendicular to Grain.....	116
2.901. Bearing at an Angle to the Grain.....	116
2.902. Eccentric Loading.....	116
2.903. Combined Concentric and Eccentric Loadings; Bolt Groups.....	116
2.904. Bolt Spacings.....	118
2.9040. Spacing of Bolts Loaded Parallel to the Grain.....	118
2.9041. Spacing of Bolts Loaded Perpendicular to the Grain.....	122
2.9042. Spacing of Bolts Loaded at an Angle to the Grain.....	122
2.9043. General Notes on Bolt Spacing.....	122
2.905. Bearing in Wood-base Materials.....	122
2.9050. Bearing in Plywood.....	122
2.9051. Bearing in Compreg.....	123
2.906. Bearing in Reinforced Members.....	125
2.9060. Wood Members with Plywood Reinforcing Plates.....	125
2.9061. Wood Members with Cross-banded Compreg Reinforcing Plates.....	125
2.907. Bushings.....	126
2.908. Hollow Bolts.....	126
2.909. General Features of Bolted Joints.....	126
2.9090. Drilling of Holes.....	126
2.9091. Repeated Loading of Bolted Joints.....	126
2.91. Glued Joints.....	126
2.910. Allowable Stress for Glued Joints.....	126
2.911. Laminated and Spliced Spars and Spar Flanges.....	127
2.912. Glue Stress Between Web and Flange.....	127
2.92. Properties of Modified Wood.....	127
2.920. Detailed Test Data for Tables 2-16 to 2-21, Inclusive.....	127
2.3. References.....	141
2.4. Bibliography.....	144

CHAPTER 3. METHODS OF STRUCTURAL ANALYSIS

3.0. GENERAL.....	146
3.00. Purpose.....	146
3.01. Special Considerations in Static Testing of Structures.....	146
3.010. Element Tests.....	146
3.011. Complete Structures.....	147
3.0110. Design Allowances for Test Conditions.....	147
3.0111. Test Procedure.....	147
3.1. WINGS.....	148
3.10. General.....	148
3.11. Two-spar Wings with Independent Spars.....	148
3.110. Spar Loadings.....	148
3.111. Chord Loading.....	149
3.112. Lift-truss Analysis.....	150
3.1120. General.....	150
3.1121. Lift Struts.....	152
3.1122. Jury Struts.....	154
3.1123. Nonparallel Wires.....	154
3.1124. Biplane Lift Trusses.....	154
3.1125. Rigging Loads.....	154
3.113. Drag-truss Analysis.....	154
3.1130. Single Drag-truss Systems.....	154
3.1131. Double Drag-truss Systems.....	155
3.1132. Fixity of Drag Struts.....	155
3.1133. Plywood Drag-truss Systems.....	155
3.114. Spar Shears and Moments.....	155
3.1140. Beam-column effects (Secondary bending).....	157

	<i>Page</i>
3.1141. Effects of Varying Axial Load and Moment of Inertia.....	158
3.115. Internal and Allowable Stresses for Spars.....	158
3.1150. General.....	158
3.1151. Wood Spars.....	158
3.116. Special Problems in the Analysis of Two-spar Wings.....	159
3.1160. Lateral Buckling of Spars.....	159
3.1161. Ribs.....	159
3.1162. Fabric Attachment.....	159
3.12. Two-spar Plywood Covered Wings.....	160
3.120. Single Covering.....	160
3.121. Box Type.....	160
3.13. Reinforced Shell Wings.....	160
3.130. General.....	160
3.131. Computation of Loading Curves.....	160
3.1310. Loading Axis.....	160
3.1311. Loading Formulas.....	162
3.132. Computation of Shear, Bending Moment, and Torsion.....	163
3.133. Computation of Bending Stresses.....	163
3.1330. Section Properties.....	165
3.1331. Bending Stress Formulas.....	167
3.134. Secondary Stresses in Bending Elements.....	168
3.135. Computation of Shear Flows and Stresses.....	168
3.1350. General.....	168
3.1351. Shear Flow Absorbed by Bending Elements.....	170
3.1352. Shear Correction for Beam Taper.....	172
3.1353. Simple D Spar.....	172
3.1354. Rational Shear Distribution.....	173
3.13540. Single Cell—General Method.....	173
3.13541. Two Cell—General Method.....	176
3.13542. Two-Cell Four-Flange Wing.....	178
3.13543. Shear Centers.....	180
3.136. Ribs and Bulkheads.....	181
3.1360. Normal Ribs.....	181
3.13600. Rib-Crushing Loads.....	181
3.1361. Bulkhead Ribs.....	181
3.137. Miscellaneous Structural Problems.....	182
3.1370. Additional Bending and Shear Stresses due to Torsion.....	182
3.1371. General Instability.....	182
3.138. Strength Determination.....	182
3.1380. Buckling in Skin.....	182
3.1381. Compression Elements.....	183
3.1382. Stiffened Panels.....	183
3.1383. Tension Elements.....	184
3.1384. Shear Elements.....	184
3.2. FIXED TAIL SURFACES.....	185
3.3. MOVABLE CONTROL SURFACES.....	185
3.4. FUSELAGES.....	186
3.40. General.....	186
3.41. Four-longeron Type.....	186
3.42. Reinforced-shell Type.....	189
3.421. Stressed-skin Fuselages.....	189
3.422. Computation of Bending Stresses.....	189
3.423. Computation of Shearing Stresses.....	191
3.43. Pure-shell Type.....	191
3.431. Monocoque shell Fuselages.....	191
3.44. Miscellaneous Fuselage Analysis Problems.....	192
3.441. Analysis of Seams.....	192
3.442. Analysis of Frames and Rings.....	192
3.4421. Main Frames.....	192
3.4422. Intermediate Frames.....	193
3.443. Effects of Cut-Outs.....	193
3.444. Secondary Structures Within the Fuselage.....	193

CHAPTER 3. METHODS OF STRUCTURAL ANALYSIS—Continued

	<i>Page</i>
3.45. Strength Determination.....	195
3.5. HULLS AND FLOATS.....	195
3.51. Main Longitudinal Girder.....	195
3.52. Bottom Plating.....	195
3.53. Bottom Stringers.....	196
3.54. Frames.....	196
3.55. Strength Determination.....	197
3.6. MISCELLANEOUS.....	197
References.....	198

CHAPTER 4. DETAIL STRUCTURAL DESIGN

4.0. GENERAL.....	199
4.00. Introduction.....	199
4.01. Definitions.....	199
4.010. Solid Wood.....	199
4.011. Laminated Wood.....	199
4.012. Plywood.....	199
4.013. High-density material.....	199
4.1. PLYWOOD COVERING.....	199
4.10. General.....	199
4.11. Joints in the Covering.....	199
4.12. Taper in Thickness of the Covering.....	199
4.13. Behavior Under Tension Loads.....	201
4.14. Behavior Under Shear Loads.....	202
4.15. Plywood Panel Size.....	202
4.16. Cut-Outs.....	203
4.2. BEAMS.....	203
4.20. Types of Beams.....	203
4.21. Laminating of Beams and Beam Flanges.....	205
4.22. Shear Webs.....	205
4.23. Beam Stiffeners.....	206
4.24. Blocking.....	206
4.25. Scarf Joints in Beams.....	207
4.26. Reinforcement of Sloping Grain.....	207
4.3. RIBS.....	207
4.30. Types of Ribs.....	207
4.31. Special Purpose Ribs.....	209
4.32. Attachment of Ribs to the Structure.....	209
4.4. FRAMES AND BULKHEADS.....	210
4.40. Types of Frames and Bulkheads.....	210
4.41. Glue Area for Attachment of Plywood Covering.....	210
4.42. Reinforcement for Concentrated Loads.....	210
4.5. STIFFENERS.....	211
4.50. General.....	211
4.51. Attachment of Stringers.....	211
4.52. Attachment of Intercostals.....	211
4.6. GLUE JOINTS.....	212
4.60. General.....	212
4.61. Eccentricities.....	212
4.62. Avoidance of End-Grain Joints.....	212
4.63. Gluing of Plywood Over Wood-Plywood Combinations.....	212
4.64. Gluing of High Density Material.....	213
4.7. MECHANICAL JOINTS.....	214
4.70. General.....	214
4.71. Use of Bushings.....	214
4.72. Use of High Density Material.....	214
4.73. Mechanical Attachment of Ribs.....	215
4.74. Attachment of Various Types of Fittings.....	215
4.75. Use of Wood Screws, Rivets, Nails, and Self-Locking Nuts.....	215
4.8. MISCELLANEOUS DESIGN DETAILS.....	216
4.80. Metal to Wood Connections.....	216

	<i>Page</i>
4.81. Stress Concentrations.....	217
4.82. Behavior of Dissimilar Materials Working Together.....	217
4.83. Effects of Shrinkage.....	217
4.84. Drainage and Ventilation.....	217
4.85. Internal Finishing.....	219
4.86. External Finishing.....	219
4.87. Selection of Species.....	220
4.88. Use of Standard Plywood.....	220
4.89. Tests.....	220
4.9. EXAMPLES OF ACTUAL DESIGN DETAILS.....	220

CHAPTER I

GENERAL

1.0. Purpose and Use of Bulletin

1.00. INTRODUCTION. This bulletin has been prepared for use in the design of both military and commercial aircraft, and contains material which is acceptable to the U. S. Air Force, Navy Bureau of Aeronautics, and the Civil Aeronautics Administration. It should, of course, be understood that methods and procedures other than those outlined herein are also acceptable, provided they are properly substantiated and approved by the appropriate agency. The applicability and interpretation of the provisions of this bulletin as contract or certification requirements will in each case be defined by the procuring or certifying agency.

1.01. SCOPE OF BULLETIN. The technical material in this bulletin is contained in chapters 2, 3, and 4, and pertains to three related phases of the structural design of wood aircraft.

Chapter 2 presents information on the strength and elastic properties of structural elements constructed of wood and plywood. This information supersedes that contained in the June 1944 edition of ANC-18, "Design of Wood Aircraft Structures."

Chapter 3 contains suggested methods of structural analysis for the design of various aircraft components. Although these methods are in many cases the same as those used for metal structures, special considerations have been introduced which take into account the orthotropic properties of wood.

Chapter 4 presents recommendations on the detail structural design of wood aircraft and contains some examples of how various manufacturers have treated the solution of specific detail design problems.

1.02. ACKNOWLEDGMENT. The Panel on Sandwich Construction of the Subcommittee on Air Force-Navy-Civil Aircraft Design Criteria and the Forest Products Laboratory express their apprecia-

tion to aircraft manufacturers and others for the valuable assistance given in connection with various parts of this bulletin.

1.1. Nomenclature

This section presents the definitions of standard structural symbols which are used in the bulletin. In addition, sections 1.10 and 1.11 are presented to clarify the differentiation between the definitions for strength and elastic properties of plywood elements and those for like properties of plywood panels. These sections also outline the use of table 2-13.

1.10. DEFINITIONS FOR PLYWOOD ELEMENTS—BEAMS, PRISMS, AND COLUMNS IN COMPRESSION, STRIPS IN TENSION. A plywood element is any rectangular piece of plywood that is supported, loaded, or restrained on two opposite edges only. In defining the various strength and elastic property terms for plywood elements the face grain direction has been used as a reference; for example, the subscript w denotes a direction parallel to (with) the face grain, while the subscript x denotes a direction perpendicular to (across) the face grain. This is illustrated by figure 1-1. The strength and elastic properties given in table 2-13 of the bulletin are for plywood elements.

1.11. DEFINITIONS FOR PLYWOOD PANELS. A plywood panel is any rectangular piece of plywood that is supported, loaded, or restrained on more than two edges. In defining the various strength and related property terms for plywood panels, the

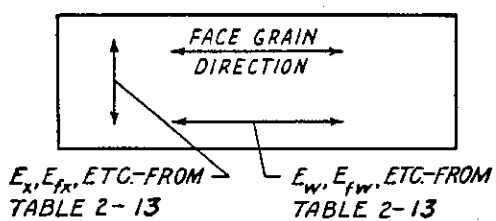
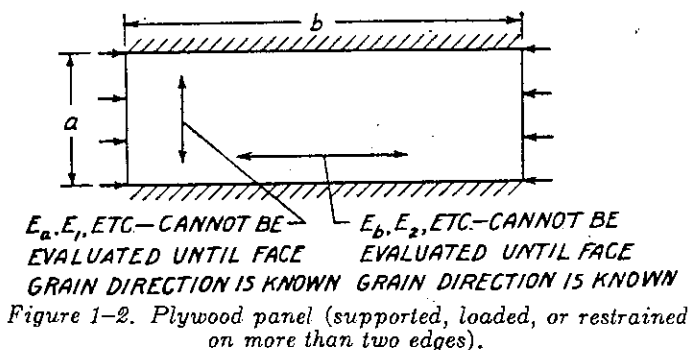

Figure 1-1. Plywood element (supported, loaded, or restrained on two opposite edges only).

side of length a rather than the face grain direction has been used as the reference. For any panel having tension or compression loads (either alone or accompanied by shear) the side of length a is the loaded side. For panels having only shear loads (with no tension or compression), the side a may be taken as either side (sec. 2.715). For panels having normal loads, side a is the shorter side. The subscripts a and 1 denote a direction parallel to the side of length a , and the subscripts b and 2 denote a direction perpendicular to the side of length a . This is illustrated by figure 1-2.



E_w, E_x, E_{fw}, E_{fx} , etc., respectively, in table 2-13. This is illustrated by figure 1-3.

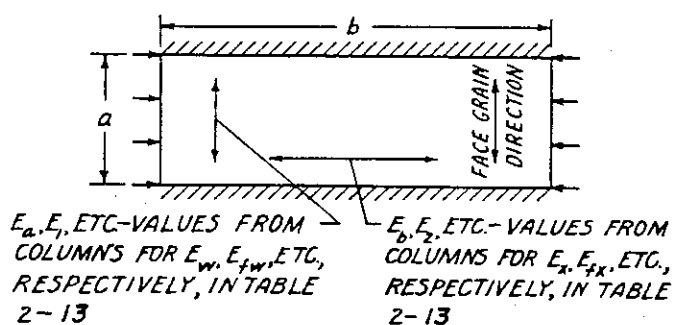

Figure 1-3. Plywood panel (face grain direction parallel to side of length a).

- (2) When the face grain direction of a plywood panel is perpendicular to the side of length a , the values of E_a, E_b, E_1, E_2 , etc., may be taken from the columns for E_x, E_w, E_{fx}, E_{fw} , etc., respectively, in table 2-13. This is illustrated by figure 1-4.

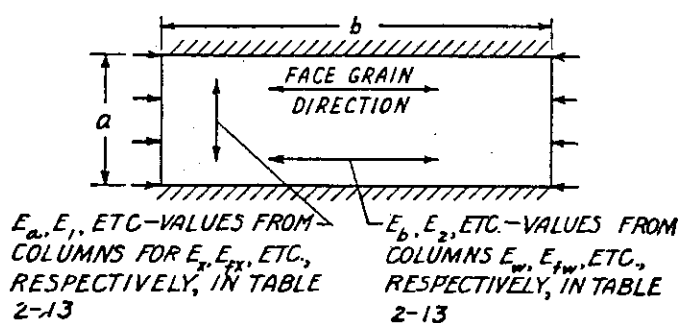

Figure 1-4. Plywood panel (face grain direction perpendicular to side of length a).

Since, in panels, the directions in which E_a, E_b, E_1, E_2 , etc., are to be measured are related to the directions of the sides of lengths a and b , it is necessary to relate these directions to the face grain direction before the terms can be evaluated from table 2-13. It may be stated, therefore, that:

- (1) When the face grain direction of a plywood panel is parallel to the side of length a , the values of E_a, E_b, E_1, E_2 , etc., may be taken from the columns for

1.12. STANDARD STRUCTURAL SYMBOLS FOR CHAPTER 2. In general, symbols that are used only in the section where they are defined are not included in this nomenclature.

- | | |
|--|--|
| <p>A —area of cross section, square inches (total).</p> <p>A_L —area of plies with grain direction parallel to the direction of applied stress.</p> <p>A_T —area of plies with grain direction perpendicular to the direction of applied stress (surfaces of plies parallel to plane of glue joint tangential to the annual growth rings, as for rotary-cut or flat-sliced veneer, flat-sawn lumber).</p> | <p>a —the length of the loaded side of a plywood panel for compression or tension loads, and the length of either side for shear loads (sec. 2.715); subscript denoting parallel to side of length a for plywood panels.</p> |
|--|--|

- A_R —area of plies with grain direction perpendicular to the direction of applied stress (surfaces of plies parallel to plane of glue joint radial to the annual growth rings, as for quarter-sliced veneer, quarter-sawn lumber).
- B
- C —circumference.
- D —diameter.
- D_w —depending on direction of stiffeners,
 $\frac{E_{fw}t^3}{12\lambda_f}$ or $\frac{E_{fz}t^3}{12\lambda_f}$
- D_{wc} —same as D_w except that the stiffener is considered to be an extra ply of the plywood.
- D_{we} —same as D_w but these are effective values applicable to the stiffened panel as a whole.
- D_z —depending on direction of stiffeners,
 $\frac{E_{fz}t^3}{12\lambda_f}$ or $\frac{E_{fw}t^3}{12\lambda_f}$
- D_{zc} —same as D_z except that the stiffener is considered to be an extra ply of the plywood.
- D_{ze} —same as D_z but these are effective values applicable to the stiffened panel as a whole.
- D_{wz} $\frac{G_{fwz}t^3}{12}$
- D_{wzc} —same as D_{wz} except that the stiffener is considered to be an extra ply of the plywood.
- D_{wze} —same as D_{wz} but these are effective values applicable to the stiffened panel as a whole.
- b —the length of the unloaded side of a plywood panel for compression or tension loads, and the length of either side for shear loads (sec. 2.715); subscript denoting parallel to side of length b for plywood panels; subscript denoting "bending" for solid wood.
- b_T —subscript denoting "bearing."
- c —end-fixity coefficient for columns; subscript denoting "compression"; distance from neutral axis to extreme fiber.
- c' —distance from neutral axis to the extreme fiber having grain direction parallel to the applied stress (plywood).
- cr —subscript denoting "critical."
- d —depth or height.

- E_L —modulus of elasticity of wood in the direction parallel to the grain, as determined from a static bending test. (This value is listed in table 2-4.)
- E_R —modulus of elasticity of wood in the direction radial to the annual growth rings.
- E_T —modulus of elasticity of wood in the direction tangential to the annual growth rings.
- E_{Lc} —modulus of elasticity of wood in the direction parallel to the grain, as determined from a compression test (value *not* listed in table 2-3, but approximately equal to 1.1 E_L).
- e_L —unit strain (tension or compression) in the L direction.
- e_R —unit strain (tension or compression) in the R direction.
- e_T —unit strain (tension or compression) in the T direction.
- e_{LT} —unit strain (shear); the change in angle between lines originally drawn in the L and T directions.
- e_{LR} —unit strain (shear); the change in angle between lines originally drawn in the L and R directions.
- e_{TR} —unit strain (shear); the change in angle between lines originally drawn in the T and R directions.
- E_a —effective modulus of elasticity of plywood in tension or compression measured parallel to the side of length a of plywood panels.
- E_b —effective modulus of elasticity of plywood in tension or compression measured perpendicular to the side of length a of plywood panels.
- E_g — E_a or E_b as required.
- E_w —effective modulus of elasticity of plywood in tension or compression measured parallel to (*with*) the grain direction of the face plies.
- E_x —effective modulus of elasticity of plywood in tension or compression measured perpendicular to (*across*) the grain direction of the face plies.
- E_{fw} —effective modulus of elasticity of plywood in flexure (*bending*) measured parallel to (*with*) the grain direction of the face plies.
- E_{fx} —effective modulus of elasticity of plywood in flexure (*bending*) measured perpendicular to (*across*) the grain direction of the face plies.
- E'_{fx} —same as E_{fx} , except that outermost ply on tension side is neglected (not to be used in deflection formulas.)

E_s	— E_L of a stiffener.		
E_1	—effective modulus of elasticity of plywood in flexure (<i>bending</i>) measured parallel to the side of length a of plywood panels, or parallel to the axis of plywood cylinders.		
E_2	—effective modulus of elasticity of plywood in flexure (<i>bending</i>) measured perpendicular to the side of length a of plywood panels.		
F	—allowable stress; stress determined from test.	f	—internal (or calculated) stress; subscript denoting "flexure" (<i>bending</i>) for plywood.
F_b	—allowable bending stress.	f_b	—internal (or calculated) primary bending stress.
F_{bu}	—modulus of rupture in bending for solid wood parallel to grain.		
F_{bp}	—fiber stress at proportional limit in bending for solid wood parallel to grain.		
F_{brp}	—bearing stress at proportional limit parallel to the grain for solid wood.	f_{br}	—internal (or calculated) bearing stress.
F_{brT}	—allowable ultimate bearing stress perpendicular to grain for solid wood (either radial or tangential to the annual growth rings).		
F_{bru}	—allowable ultimate bearing stress parallel to grain.		
F_c	—allowable compressive stress.	f_c	—internal (or calculated) compressive stress.
F_{cer}	—critical compressive stress for the buckling of rectangular plywood panels.	f_{cL}	—internal (or calculated) compressive stress in a longitudinal ply; i. e., any ply with its grain direction parallel to the applied stress.
F_{cp}	—stress at proportional limit in compression parallel to grain for solid wood.		
F_{cpT}	—stress at proportional limit in compression perpendicular to grain for solid wood (either radial or tangential to the annual growth rings).		
F_{cpw}	—stress at proportional limit in compression for plywood having the face grain direction parallel to (<i>with</i>) the applied stress.		
F_{cpx}	—stress at proportional limit in compression for plywood having the face grain direction perpendicular to (<i>across</i>) the applied stress.		

- $F_{cp\theta}$ —stress at proportional limit in compression for plywood having the face grain direction at an angle θ to the applied stress.
- F_{cu} —ultimate compressive stress parallel to the grain for solid wood.
- F_{cuT} —compressive strength perpendicular to grain for solid wood (either radial or tangential to the annual growth rings) (sec. 2.1000).
- F_{cuw} —ultimate compressive stress for plywood having the face grain direction parallel to (*with*) the applied stress.
- F_{cuz} —ultimate compressive stress for plywood having the face grain direction perpendicular to (*across*) the applied stress.
- $F_{c\theta}$ —ultimate compressive stress for plywood having the face grain direction at an angle θ to the applied stress.
- F_s —allowable shearing stress.
- F_{scr} —critical shear stress for the buckling of rectangular plywood panels.
- F_{st} —modulus of rupture in torsion.
- F_{su} —ultimate shear stress parallel to grain for solid wood.
- $F_{s\theta c}$ —ultimate shear stress for plywood, wherein θ designates the angle between the face grain direction and the shear stress in a plywood element so loaded in shear that the face grain is stressed in compression.
- $F_{s\theta t}$ —ultimate shear stress for plywood, wherein θ designates the angle between the face grain direction and the shear stress in a plywood element so loaded in shear that the face grain is stressed in tension.
- F_{suw} —ultimate shear stress for plywood elements for the case where the face grain is at 0° and 90° to the shear stress.
- F_t —allowable tension stress.
- F_{tu} —ultimate tensile stress parallel to grain for solid wood.
- F_{tuT} —tensile strength perpendicular to grain for solid wood (either radial or tangential to the annual growth rings).
- f_s —internal (or calculated) shearing stress.
- f_t —internal (or calculated) tensile stress.
- f_{tL} —internal (or calculated) tensile stress in a longitudinal ply (any ply with its grain direction parallel to the applied stress).

F_{tuz}	—ultimate tensile stress for plywood having the face grain direction parallel to (<i>with</i>) the applied stress.		
F_{tuz}	—ultimate tensile stress for plywood having the face grain direction perpendicular to (<i>across</i>) the applied stress.		
$F_{tu\theta}$	—ultimate tensile stress for plywood having the face grain direction at an angle θ to the applied stress.		
G	—mean modulus of rigidity taken as $\frac{1}{6}$ of E_L .	g	—length of side of panel and equal to a or b as is required.
G_{LT}	—modulus of rigidity associated with shear deformations in the LT plane resulting from shear stresses in the LR and RT planes.		
G_{LR}	—modulus of rigidity associated with shear deformations in the LR plane resulting from shear stresses in the LT and RT planes.		
G_{TR}	—modulus of rigidity associated with shear deformations in the TR plane resulting from shear stresses in the LT and LR planes.		
H	—a constant, generally theoretical.	h	—height or depth.
I	—moment of inertia.	i	—subscript denoting “ i^{th} ply.”
I_p	—polar moment of inertia.	j	—stiffness factor $\sqrt{EI/P}$
J	—torsion constant (I_p for round tubes).	k	—stiffness factor
K	—a constant, generally empirical.		$\frac{E_{fuz} + 2\lambda_f G_{fuz}}{\sqrt{E_{fw} E_{fz}}}$
L	—length; span; subscript denoting the direction parallel to the grain.	l	—not used, to avoid confusion with the numeral 1.
L'	$= \frac{L}{\sqrt{c}}$ where c is the end-fixity coefficient.		
M	—applied bending moment.	m	—number of half waves.
N	—	n	—number of plies, number of stiffeners.
P	—applied load (total, not unit load).	p	—subscript denoting “polar”; subscript denoting “proportional limit”; load per unit area.
		psi	—pounds per square inch.
Q	—static moment of a cross section.	q	—shear flow, pounds per inch.
R	—subscript denoting the direction radial to the annual growth rings and perpendicular to the grain direction.	r	—radius; adjusted ratio length to width
S	—shear force.		$\frac{b}{a} \left(\frac{E_1}{E_2} \right)^{1/4}$
T	—applied torsional moment, torque; subscript denoting the direction tangential to the annual growth rings and perpendicular to the grain direction.	s	—distance c to c of adjacent stiffeners; subscript denoting “shear”.
		t	—thickness; subscript denoting “tension”.
		t_c	—thickness of central ply.
		t_f	—thickness of face ply.

U	—	u	—subscript denoting “ultimate”.
W	—	w	—deflection of plywood panels; load per linear inch; subscript denoting parallel to face grain of plywood.
X	—	x	—subscript denoting perpendicular to face grain of plywood.
Y	—	y	—distance from the neutral axis to any given fiber.
Z	—section modulus, I/c	z	—
Z_p	—polar section modulus, I_p/c .	z_n	—distance between center of panel and neutral axis of panel stiffener combination.
		β	—the angle between side of length b and the face grain direction as used in the determination of buckling criteria for panels (sec. 2.71).
		δ	—deflection.
		θ	—usually the acute angle in degrees between the face grain direction and the direction of the applied stress; angle of twist in radians in a length (L).
		μ_{LT}	—Poisson's ratio of contraction along the direction T to extension along the direction L due to a normal tensile stress on the RT plane; similarly, μ_{LR} , μ_{RT} , μ_{TR} , μ_{RL} , and μ_{TL} .
		ρ	—radius of gyration.
		ϕ	—usually the acute angle in degrees between the face grain direction and the axis of extension.

CHAPTER 2

STRENGTH OF WOOD AND PLYWOOD ELEMENTS

2.0. Physical Characteristics and Factors Affecting the Strength of Wood

2.00. ANISOTROPY OF WOOD. Wood, unlike most other commonly used structural materials, is not isotropic. It is a complex structural material, consisting essentially of fibers of cellulose cemented together by lignin. It is the shape, size, and arrangement of these fibers, together with their physical and chemical composition that govern the strength of wood, and account for the large difference in properties along and across the grain (ref. 2-20).

The fibers are long and hollow tubes tapering toward the ends, which are closed. Besides these vertical fibers, which are oriented with their longer dimension lengthwise of the tree and comprise the principal part of what is called wood, all species, except palms and yuccas, contain horizontal strips of cells known as rays, which are oriented radially and are an important part of the tree's food transfer and storage system. Among different species the rays differ widely in their size and prevalence.

From the strength standpoint, this arrangement of fibers results in an anisotropic structure, that accounts for three Young's moduli differing by as much as 150 to 1, three shear moduli differing by as much as 20 to 1, six Poisson's ratios differing by as much as 40 to 1, and other properties differing by various amounts. Not all of these wood properties have, as yet, been thoroughly evaluated.

Figure 2-1 shows a diagrammatic sketch of the cellular structure of wood. Each year's growth is represented by one annual ring. The portion of the growth occurring in the spring consists of relatively thin-walled fibers, while that occurring during the later portion of the growing season consists of fibers having somewhat heavier walls. Thus, there is, for most woods, a definite line of

demarcation between the growth occurring in successive years. The relation between the cellular structure of the wood and the three principal axes—longitudinal (*L*), tangential (*T*), and radial (*R*)—is indicated on the sketch. Figure 2-2 shows the relation between these axes and (a) the log, (b) a flat-sawn board or rotary-cut veneer, and (c) an edge-grain board or quarter-sliced veneer.

2.01. DENSITY OR APPARENT SPECIFIC GRAVITY. The substance of which wood is composed is actually heavier than water, its specific gravity being nearly the same for all species and averaging about 1.5. Since a certain proportion of the volume of wood is occupied by cell cavities, the apparent specific gravity of the wood of most species is less than unity.

Relations between various strength properties and specific gravity have been developed (table 2-1) and are useful in estimating the strength of a piece of wood of known specific gravity. Considerable variability from these general relations is found, so that while they cannot be expected to give exact strength values, they do give good estimates of strength. Minimum permissible specific gravity values are listed in section 2.10.

The exponential values shown in table 2-1 apply to variation within a species. That is, they are to be used in determining the relation between the strength properties of pieces of the same species but of different specific gravity. For expressing the relation between the average strength properties of different species, the exponential values are somewhat lower. Such values are shown in table 14 of U. S. Department of Agriculture Technical Bulletin 479 (ref. 2-57).

2.02. MOISTURE CONTENT. Wood in the natural state in the living tree has considerable water associated with it. After being converted to lumber or other usable form, or during conversion,

wood is commonly dried so that most of the water is removed.

The water is associated with the wood in two ways, either absorbed in the cell walls, or as free water in the cell cavities. During drying, the free water in the cell cavities is removed first, then that absorbed in the cell walls. The point at which all the water has been removed from the cell cavities while the cell walls remain saturated is known as the fiber-saturation point. For most species, the moisture content at fiber saturation is from 22 to 30 percent of the weight of the dry wood.

Lowering the moisture content to the fiber-saturation point results in no changes in dimension or in strength properties. Lowering the moisture content below the fiber-saturation point, however, results in shrinkage and an increase in strength properties.

Wood is a hygroscopic material, continually giving off or taking on moisture in accordance with the relative humidity and temperature to which it is exposed. Thus, while the strength of a piece of wood may be increased to a relatively high value by drying to a low moisture content, some of that increase may be lost if, in use, it is exposed to atmospheric conditions that tend to increase the moisture content. While paint and other coatings may be employed to retard the rate of absorption of moisture by wood, they do not change its hygroscopic properties, thus a piece of wood may be expected to come to the same moisture content under the same exposure conditions whether painted or unpainted. The time required will vary, depending upon whether or not it is coated. It is desirable, therefore, to design a structure on the basis of the strength corresponding to the conditions of use.

Moisture content is generally expressed as a percentage of the dry weight of the wood. The percentage variation of wood strength properties for 1 percent change in moisture content is given in table 2-2. Since this variation is an exponential function (ref. 2-85), it is necessary that strength adjustments based on the percentage changes given in the table be made successively for each 1 percent change in moisture content until the total change has been covered. Figure 2-3 is a chart by means of which the ratio between the adjusted strength and the original strength may be determined approximately if the proper correction factor is obtained from table 2-2 and the difference in moisture content for which correction is

desired is known. For positive correction factors in table 2-2, the original strength is multiplied by the strength ratio factor determined from figure 2-3 for adjustments involving decrease in moisture content, and divided by the strength ratio factor for those involving increase in moisture content. For negative factors in table 2-2, the original strength is divided by the strength ratio factor for adjustments involving decrease in moisture, and multiplied for adjustments involving increase in moisture.

Table 2-1. Variation of wood strength properties with specific gravity¹

$$\frac{S}{S'} = \left(\frac{g}{g'}\right)^n$$

S = strength at specific gravity g

S' = strength at specific gravity g' (usually average values from column (2) of tables 2-6 and 2-7)

Static bending:		<i>n</i>
Fiber stress at proportional limit.....	1.50	
Modulus of rupture.....	1.50	
Modulus of elasticity.....	1.25	
Work to maximum load.....	2.00	
Total work.....	2.25	
Impact bending:		
Fiber stress at proportional limit.....	1.50	
Modulus of elasticity.....	1.25	
Height of drop.....	2.00	
Compression parallel to grain:		
Fiber stress at proportional limit.....	1.25	
Maximum crushing strength.....	1.25	
Modulus of elasticity.....	1.25	
Compression perpendicular to grain:		
Fiber stress at proportional limit.....	2.50	
Hardness—end, radial, tangential.....	2.50	

¹ Values in this table apply only to variations within a species. See section 2.01.

2.03. SHRINKAGE. Reduction of moisture content below the fiber-saturation point results in a change in dimension of the wood. Shrinkage in the longitudinal direction is generally negligible, but in the other two directions it is considerable. In general, radial shrinkage is less than tangential, the ratio between the two varying with the species.

A quarter-sawed board will, therefore, shrink less in width but more in thickness than a flat-sawed board. The smaller the ratio of radial to tangential shrinkage, the more advantage is to be gained through minimizing shrinkage in width by

using a quarter-sawed board. The smaller the difference between radial and tangential shrinkage, the less, ordinarily, is the tendency to check in drying and to cup with changes in moisture content.

In general, woods of high specific gravity shrink

and swell more for a given change in moisture content than do woods of low specific gravity.

2.04. TEMPERATURE. The strength of wood is greatly influenced by its temperature, but the magnitude of the effect depends upon the moisture content of the wood and the time of exposure.

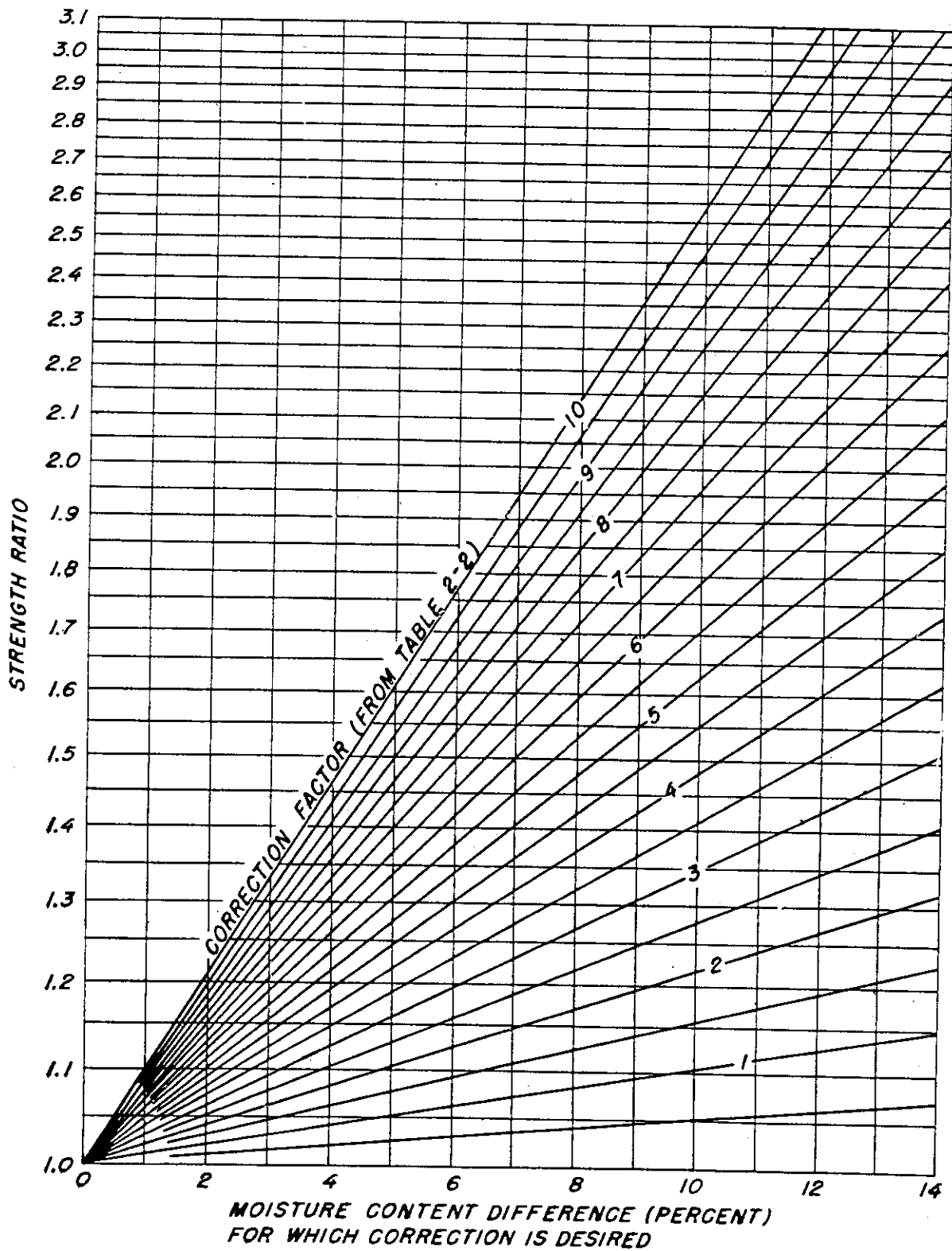

Figure 2-8. Strength ratio chart for use in making strength-moisture adjustments.

Table 2-2. Percentage increase in wood strength properties for 1 percent decrease in moisture content¹

Species	Static bending				Compression parallel to grain, maximum crushing strength	Compression perpendicular to grain	Shearing strength parallel to grain	Hardness (side)
	Fiber stress at proportional limit	Modulus of rupture	Modulus of elasticity	Work to maximum load ²				
(1)	(2)	(3)	(4)	(5)	(6)	(7)	(8)	(9)
Hardwoods:³								
Ash, black	8.9	6.4	3.6	1.8	8.3	6.8	5.1	4.1
Ash, commercial white	4.1	3.5	1.4	.4	4.7	4.8	2.9	2.4
Basswood, American	6.8	4.8	2.9	2.6	6.5	6.6	4.2	4.2
Beech, American	6.0	4.7	1.8	2.0	6.2	5.3	3.8	3.6
Birch, sweet	6.4	5.0	2.3	1.2	7.1	7.2	5.0	3.6
Birch, yellow	6.0	4.8	2.0	1.7	6.1	5.6	3.6	3.3
Cherry, black	6.6	3.6	1.1	1.0	6.0	5.5	3.5	3.1
Cottonwood	5.8	4.1	2.5	.1	6.6	5.7	2.6	1.8
Elm, rock	4.7	3.8	2.1	-.3	5.3	6.1	3.5	2.8
Hickory (true hickories)	4.9	4.8	2.8	-.7	5.9	6.6	3.9	
Khaya ("African mahogany")	3.2	2.5	1.6	-.6	3.2	3.0	.4	3.1
Mahogany	2.6	1.3	.8	-2.9	2.5	3.9		1.0
Maple, sugar	5.2	4.4	1.4	1.9	5.7	7.1	3.9	3.4
Oak, commercial white and red	4.6	4.4	2.4	1.7	5.9	4.4	3.5	1.8
Sweetgum	6.7	4.7	2.2	1.5	6.1	5.4	3.5	2.4
Walnut, black	5.8	3.7	1.4	-2.6	4.8	6.3	1.0	1.0
Yellow-poplar	5.0	4.6	2.7	1.9	6.7	4.8	3.3	2.4
Softwoods (conifers):³								
Baldcypress	4.6	4.0	1.6	1.8	4.9	5.1	1.7	2.3
Douglas-fir	4.5	3.7	1.8	1.9	5.5	5.0	1.7	2.9
Fir, noble	5.1	4.7	1.9	3.2	6.1	5.5	2.3	3.1
Hemlock, western	4.7	3.4	1.4	.7	5.0	3.7	2.5	2.0
Incense cedar, California	3.4	2.1	1.8	-1.4	4.3	4.0	.4	1.5
Pine, eastern white	5.6	4.8	2.0	2.1	5.7	5.6	2.2	2.2
Pine, red	8.0	5.7	2.2	4.7	7.5	7.2	3.9	4.5
Pine, sugar	4.4	3.9	2.1	.1	5.4	4.4	3.7	1.9
Pine, western white	5.3	5.1	2.2	4.8	6.5	5.2	2.5	1.5
Redcedar, western	4.3	3.4	1.6	1.3	5.1	5.1	1.6	2.3
Spruce, red and Sitka	4.7	3.9	1.7	2.0	5.3	4.3	2.6	2.4
Spruce, white	5.8	4.8	1.9	2.1	6.5	5.7	3.7	3.3
White-cedar, northern	5.4	3.6	1.8	-1.5	5.9	2.3	2.8	3.0
White-cedar, Port Orford	5.7	5.2	1.6	1.7	6.2	6.7	2.2	2.8

¹ Corrections to the strength properties should be made successively for each 1 percent change in moisture content until the total change has been covered. For each 1 percent decrease in moisture content, the strength is multiplied by $(1+P)$, where P is the percentage correction factor shown in the table, expressed as a decimal. For each 1 percent increase in moisture content, the strength is divided by $(1+P)$.

² Negative values indicate a decrease in work to maximum load for a decrease in moisture content.

³ For tension values see section 2.5411.

Although considerable literature exists relating to permanent strength reductions resulting from prolonged or cyclic exposure to temperature extremes (ref. 2-46, 2-57, 2-84) few investigations have been made with respect to transient or reversible effects resulting from differences in temperature (ref. 2-2, 2-26, 2-28, 2-36, 2-58, 2-73, 2-76, 2-81).

Broadly, it would appear from data now available that prolonged exposure to temperatures

above about 150° F. may result in a permanent loss of strength, and that within the range 0° F. to 150° F. the reduction in static strength properties (excluding modulus of elasticity) with increase in temperature for wood at about 12 percent moisture content, will approximate one-half percent per degree Fahrenheit. The effect on impact properties is variable and cannot be generalized. Some data on the mechanical properties of wood of different moisture contents over the tempera-

ture range of -328° F. to $+392^{\circ}$ F. are given in NACA Technical Memorandum No. 984, reference 2-37.

2.05. **FATIGUE PROPERTIES.** The fatigue characteristics of wood have been explored to only a limited extent (ref. 2-38, 2-39, 2-41). Tests of the Forest Products Laboratory indicate that wood is less sensitive to rapidly repeated loads than are the more crystalline structural materials, resulting in a higher endurance limit in proportion to the ultimate strength. Tension parallel-to-grain and glue joint shear tests of Douglas-fir and white oak, and tension perpendicular-to-grain tests of Douglas-fir showed an endurance load for 30 million cycles of about 40 percent of standard test strength for both solid wood and scarf-jointed specimens when the minimum repeated load was 10 percent of the maximum repeated load for each cycle. These tests were conducted at about 12 percent moisture content, at a temperature of 75° F.

Tests of small cantilever bending specimens of solid wood and plywood, subjected to fully reversed stresses under the same temperature-humidity conditions as above, indicate an endurance load of about 30 percent of the modulus of rupture of standard static tests after 30 million cycles of repeated stress.

Very little data are available on the effects of notches, bolt holes, or connectors in fatigue. Some data on the effect of notches on fatigue properties of rotating beam specimens are given in reference 2-87.

2.06. **PLASTIC PROPERTIES.** Though it is known that wood, in common with other materials of construction, exhibits plastic as well as elastic properties, quantitative evaluations of the plastic characteristics of wood are limited in scope (ref. 2-34). Thus, while recognizing that when load is applied to a wood structural member the immediate or elastic deformation subsequently will be increased by plastic yield or creep, there is, at present, no accurate means of evaluating the rate of progress of such plastic yield, nor of predicting the time at which failure may be expected to occur.

Preliminary investigations at the Forest Products Laboratory (ref. 2-66, 2-86) involve creep tests with stresses up to 3,000 pounds per square inch in tension and compression, up to 400 pounds per square inch in shear, and at stress levels approaching the short-time ultimate strength in bending. They indicate creep characteristics very

much alike in these strength properties at the lower stress levels. There is reason to believe that creep properties differ between tension and compression as stress values approach the short-time ultimate strength in compression, but the difference has not been fully explored. From these considerations, supported by a few test results, it is believed that joints and fastenings have similar creep properties insofar as their strength is controlled by the strength of the wood.

It is evident from the studies thus far completed that creep under constant load is quite rapid at first, and continues for long periods at a decreasing rate, depending upon the ratio of the applied load to that which would cause immediate failure. No critical point in time has been found at which the rate of creep suddenly changes or at which all creep ceases. Neither has there been found a stress threshold below which no creep takes place.

The studies in bending and compression have indicated that with stresses at, or less than, 60 percent of the strength in a standard laboratory test, the ratio of creep to initial strain is approximately constant. Since strain in this range is proportional to stress, it may be said that creep is proportional to stress. Both in compression and bending, creep at 5 minutes is generally less than 2 percent, and at 1 hour is about 4 percent of the initial strain or deflection. Where stresses in bending exceed 60 percent of laboratory test strength, creep percentages are higher than the above values.

It is known that temperature and moisture changes influence plastic properties, but the extent of such effects is not known.

When load is removed from wood, the elastic strain is recovered immediately. There is, in addition, a recovery of a portion of the plastic strain, relatively rapid at first, and continuing more and more slowly for considerable periods of time. Little is known of the nature and extent of recovery, or of permanent set characteristics, hysteresis, or damping capacity (see sec. 2.095).

In bending, successive repetitions of the same load separated by periods of recovery cause successively increased deformations which finally lead to failure. From data now available it appears that the sum of the periods under intermittent load, until failure occurs, is somewhat greater than the duration to failure under constant load at the same stress level.

2.07. **IMPACT PROPERTIES.** The rate at which

load is applied to a wood member, as well as the time during which it acts, has an important effect on its ability to carry load (secs. 2.06 and 2.10).

Under extremely rapid loading conditions, such as are obtained in impact tests where failure may occur in a fraction of a second, a wood member would be expected to withstand a force much greater than in a standard test. Exact relationships of failing stresses under static and impact loadings are not well known as, in impact tests, measurement is generally made of the absorbed energy rather than the stress imposed.

A beam subjected to impact loading in the standard drop hammer impact bending test (ref. 2-57) may deflect about twice as much before failure as under static test conditions. The stress required to produce failure under such impact conditions is, therefore, correspondingly, about twice as great as for static conditions.

The shock resistance of wood may be measured by a single-blow impact test such as the "toughness" test described in USDA Tech. Bul. 479 (ref. 2-57) where average toughness values for common species are listed, together with minimum acceptance requirements for a number of aircraft woods.

Recent data of the Forest Products Laboratory (ref. 2-10, 2-14) show that the toughness of wood is considerably influenced by its moisture content. Above the fiber-saturation point, approximately 30 percent moisture content, toughness is apparently independent of changes in moisture. For drier material the toughness, in general, decreases slowly from the green value to a minimum at about 12 to 18 percent moisture content, and then increases substantially with further decrease in moisture. These conclusions are in general agreement with extensive toughness and Izod tests by the Australian Forest Products Laboratory (ref. 2-35) but it has been found that results vary greatly among species, and no adequate general formula can be devised to represent toughness-moisture relations for all species.

2.08. EFFECT OF LIQUIDS. Some liquids, when absorbed by wood, adversely affect the strength properties, others do not. In general, nonpolar, nonswelling liquids that do not react with wood chemically do not affect the strength (ref. 2-19). For example, saturated, straight-chain hydrocarbon oils, such as gasoline, kerosene, and most lubricating oils, and aromatic hydrocarbons, such as benzene and toluene, have no significant effect

on the strength of wood and they do not raise the grain.

Turpentine, mineral paint thinners, and linseed oil will by analogy cause practically no effect upon the strength properties nor will cleaning fluids such as carbon tetrachloride.

Low molecular-weight, simple alcohols such as methyl (wood alcohol), ethyl (grain alcohol), and propyl alcohol and polyhydric alcohols such as ethylene glycol (antifreeze) and glycerine swell wood appreciably and cause a considerable loss in strength properties, varying from half to almost the full strength loss caused by water. In general, the crushing strength is decreased somewhat less than it would be if swollen to the same extent in water (ref. 2-19, 2-60).

Lacquer solvents, such as acetone, methyl and ethyl acetates, and ethylene glycol monoethyl ether will reduce the strength about half as much as water.

Low molecular-weight organic acids, such as acetic acid, will reduce the strength about three-fourths as much as water. The high molecular-weight fatty acids will have a much smaller but positive effect.

These various liquids reduce the strength of wood only while they remain in the wood. Volatile liquids, hence, have only a short, temporary effect upon the strength. Low volatility liquids like glycerine will reduce the strength over considerable periods of time. These are apparently the only liquids with which the aircraft industry need be concerned. Some hydraulic fluids containing glycerine or ethylene glycol have an experimentally demonstrated detrimental effect upon the strength of wood (ref. 2-11).

Another group of liquids, strong mineral acids and bases, have a permanent effect upon the strength of woods as a result of chemical degradation of the wood. This degradation varies with species. The only comprehensive data available on the subject are given in the tables 2-3 and 2-4.

2.09. MISCELLANEOUS PHYSICAL PROPERTIES.

2.091. *Coefficient of expansion.* The isotropic nature of wood results in differing coefficients of thermal expansion (α) along its radial, tangential, and fiber axes. This anisotropy, modified by the treatments involved, remains a basic property of all the derived structural products of wood, in which the fiber arrangement is not destroyed.

The thermal expansion of wood is so small as to

Table 2-3. Deterioration due to four weeks soaking in acids and bases at room temperature measured by the modulus of rupture relative to that for matched water-soaked specimens. Concentrations, 2 to 10 percent (ref. 2-36)

Species	Hydrochloric acid	Sulfuric acid	Nitric acid	Sodium hydroxide	Ammonium hydroxide
Larch.....	¹ 1.09-0.81	1.11-1.00	1.07-0.95	0.96-0.52	1.06-0.92
Pine.....	1.08-.84	1.13-0.84	1.07-.93	.96-.51	1.00-.79
Spruce.....	1.00-.82	1.02-.94	.98-.96	.93-.44	.98-.75
Beech.....	.96-.55	.97-.87	.83-.71	.59-.31	.67-.43
Oak.....	.93-.52	.97-.82	.83-.65	.58-.29	.65-.36
Basswood.....	.88-.48	.87-.81	.76-.57	.55-.21	.61-.33

¹ Values greater than unity due to the fact that acid is more slowly absorbed by the wood than water.

Table 2-4. Loss in breaking load in percent due to soaking in acids at room temperature relative to matched water-soaked specimens (ref. 2-1)

Species	Hydrochloric acid 82 days		Sulfuric acid 82 days		Acetic acid 135 days	
	5 percent concentration	15 percent concentration	10 percent concentration	20 percent concentration	50 percent concentration	80 percent concentration
	Percent	Percent	Percent	Percent	Percent	Percent
Teak.....	31	50	17	31	43	39
Oak.....	54	76	48	40	39	26
Pine.....	18	46	11	16	20	0

be unimportant in ordinary usage, for example, a 1 percent increase in moisture content swells yellow birch as much as does an 80° C. thermal expansion. Only meager data are available on the coefficients of thermal expansion of wood and wood-base materials, and investigators are not in close agreement in their values although there is general agreement that the expansion across the grain is much greater than that along the grain (ref. 2-20).

A comprehensive study of the thermal expansion of wood and wood-base products has been completed recently at the Forest Products Laboratory, and the results have been published (ref. 2-82). In this work the variation of the coefficients of linear thermal expansion with specific gravity was determined on a series of solid, oven-dry specimens of 9 different species of untreated wood. The effects of radial compression, resin-treating, and cross-banding on the values of the coefficients were determined on birch laminates. The values of the coefficients for papreg and hydrolyzed-wood plastic were also determined.

The average coefficients of linear thermal expansion (α) per ° C. of nine species of solid wood (ref. 2-82) from +50 to -50° C. for the average specific gravity of the species are given in the following tabulation:

Species	Average specific gravity ¹	$\alpha_t \times 10^6$	$\alpha_r \times 10^6$	$\alpha_l \times 10^6$
Yellow Birch.....	0.66	38.3	30.7	3.36
Sugar Maple.....	.68	35.3	26.8	3.82
Yellow-poplar.....	.43	29.7	27.8	3.17
Cottonwood.....	.43	32.6	23.2	2.89
Balsa.....	² .17	³ 24.1	³ 16.3	-----
Douglas-fir ³51	42.7	27.9	3.16
Sitka spruce.....	.42	32.3	23.8	3.15
White fir.....	.40	32.6	21.8	3.34
Redwood.....	.42	35.1	23.6	4.28

¹ Average specific gravity (based on weight and volume when oven dry) taken from tables of properties in U. S. D. A. Tech. Bull. No. 479 (ref. 2-57) or for specimens included in this study.

² Specific gravity average of values for two specimens tested.

³ α measured from +50 to 0° C. only.

The coefficients of linear thermal expansion in the tangential (α_t) and radial directions (α_r) may be calculated for specific gravities other than those tabulated by use of the following equation:

$$\alpha = \alpha_0 \frac{G}{G_0} \quad (2:1)$$

where

α = coefficient of linear thermal expansion (α_t or α_r) at specific gravity G

α_c = coefficient of linear thermal expansion (α , or α_r) listed

G_o = specific gravity listed

G = specific gravity desired

The coefficient of linear thermal expansion parallel to the grain (α_l) is independent of specific gravity, and is unaffected by radial or tangential compression.

The dependency of the coefficient of linear thermal expansion on resin content in a solid piece is expressed by:

$$\alpha_c = \frac{E_w \alpha_w (1 - n_r) + E_r \alpha_r n_r}{E_w (1 - n_r) + E_r n_r} \quad (2:2)$$

where

α_c = coefficient of linear thermal expansion (α) of the wood-resin system

α_w = of wood alone

α_r = of resin alone.

E = modulus of elasticity (subscripts have the same meaning as for α)

n_r = fraction of solid cross-section of sample consisting of resin

General formulas were developed at the Forest Products Laboratory that permit calculation of the coefficients of linear thermal expansion of wood laminates in any grain direction of the specimen, from the original and final specific gravities, the percentage by weight of resin and glue present, the percentage of cross-banding, and the slope of grain relative to any three axes of reference. Solution of the formulas, however, should be attempted only after reference to the original publication (ref. 2-82).

2.092. *Thermal conductivity.* The thermal conductivity of wood is dependent on a number of factors of varying degrees of importance. Some of the more significant variables affecting the rate of heat flow in wood are the following: density and moisture content of the wood; direction of heat flow with respect to the grain; kind, quantity, and distribution of extractives or chemical substances; relative density and proportion of springwood and summerwood; defects, like checks, knots, and cross-grain structure.

The Forest Products Laboratory has made careful determinations of the thermal conductivity of wood at various moisture contents. These tests, which covered 32 species, have furnished sufficient data on the relationship between conductivity, specific gravity, and moisture content to make it possible to compute the approximate

thermal conductivity for any wood for which the specific gravity is known and for which the moisture content can be determined or assumed. Such conductivities have many practical applications, such as in estimating the thermal resistance or insulating value of various woods; thermal resistance being the reciprocal or inverse value of conductivity.

It is common engineering practice to express heat conductivity, represented by K , as the amount of heat in British thermal units that will pass in 1 hour through 1 square foot of the material 1 inch thick per degree Fahrenheit temperature difference between the faces.

Although it is not practicable (ref. 2-45) to compute the exact conductivity of wood of given density and moisture content because of the number of variables involved, the following equations permit calculation of conductivity closely enough for practical purposes:

For wood having a moisture content under 40 percent:

$$K = S(1.39 + 0.028M) + 0.165 \quad (2:3)$$

For wood having a moisture content of 40 percent or more:

$$K = S(1.39 + 0.038M) + 0.165 \quad (2:4)$$

Where

K = conductivity

S = specific gravity based on volume at current moisture and weight when oven-dry

M = moisture content

Conductivities of wood aircraft parts will ordinarily be computed by means of equation (2:3) using 15 percent for the moisture content of aircraft to be used in the continental United States and 20 percent for the moisture content of aircraft to be used under tropical conditions (sec. 2.10). The use of species average values of specific gravity may be considered sufficiently correct for most purposes.

Experiments on Douglas-fir plywood with veneer $\frac{1}{8}$ -inch or more in thickness (ref. 2-45) indicate that the thin film of glue between the wood surfaces has no important effect on conductivity, as would be expected, because of the very slight thickness of the glue coating in comparison with the total thickness.

Tests (ref. 2-45) indicate there is a small increase in conductivity with increase in temperature difference but, for temperature conditions normally encountered, the variation in conductivity is not significant.

2.093. *Ignition temperature.* Limited data are available concerning minimum temperatures required to produce charring or ignition of wood. Results obtained by different investigators for ignition temperatures show wide discrepancies. The different values reported may be due to the specific test conditions associated with the methods employed, and also to the different interpretations among investigators as to what constitutes ignition temperature (ref. 2-4). Assuming conditions favorable to the completion of the ignition process, the ignition temperature has been defined (ref. 2-4) as the temperature in the combustible at which the rate of heat developed by the reactions inducing ignition just exceeds the rate at which heat is dissipated by all causes, under the given conditions.

It is thus obvious that, unlike flammable liquids, which have reasonably definite ignition temperatures, the ignition temperature of wood, even if a standard interpretation of the phenomenon were determined upon, would vary widely depending upon the size, density, moisture content, and type, distribution, and quantity of extractives present in the specimen under test, and upon the time and rate of heating, the amount of air available, and the rate of air flow.

The importance of the time factor has been emphasized by the Forest Products Laboratory (ref. 2-49) but no specific tests have been made relating ignition temperatures to long exposures at the lower ranges of elevated temperature. The Underwriters' Laboratories (ref. 2-80) have cited an example of ignition occurring after long-continued exposure (about 15 yrs.) to a temperature of approximately 190° F.

2.094. *Electrical properties.* The resistance that wood offers to the passage of direct current depends primarily upon the moisture content of the wood (ref. 2-72). In the green state the resistivity of wood is relatively low and increases slowly with decrease in moisture until the fiber-saturation point is reached at about 30 percent moisture content, and all free water has been removed. The change of resistivity within the green range is about 50-fold. When wood is dried below the fiber-saturation point, however, its resistivity increases rapidly, about a million-fold from the fiber-satura-

tion point to the oven dry condition. The logarithm of resistivity is approximately inversely proportional to moisture content. At values of moisture content approaching zero the resistivity becomes very great, of the order of 10^{16} ohm-centimeters (ref. 2-83), and dry wood is a very good electrical insulator. In conditions of use, however, wood will not remain dry, but will absorb moisture until it reaches a condition of equilibrium corresponding with the ambient atmosphere. The resistivity of wood at a typical moisture content of 9.3 percent is 10^{10} ohm-centimeters.

When alternating voltage is applied to wood the effects depend upon both moisture content and frequency. At frequencies up to a few hundred cycles per second the behavior of wood is practically the same as for direct currents. At much higher frequencies, from a million cycles per second upward, the electrical properties of wood are essentially its properties when acting as a dielectric material. In this role it is interposed between two metallic plates or sheets to form a condenser. Wood is an imperfect dielectric and, therefore, some of the electrical energy required to charge the condenser will be lost to the wood where it appears as heat.

Losses in the wood depend principally upon its moisture content and the frequency of the applied voltage, and the losses increase with both moisture content, especially above about 10 percent, and frequency. Wood is a very poor insulator or dielectric at high frequencies. The alternating current electrical properties of wood are concerned principally with high-frequency dielectric heating for gluing purposes (ref. 2-5, 2-74).

2.095. *Damping capacity.* Damping capacity may be defined as the ability of a solid to convert mechanical energy of vibration into internal energy. This causes vibrations to die out. Published information on the subject (ref. 2-33) is mainly concerned with metals, and only occasional references are made to wood.

The damping capacity of timber has been investigated by Greenhill (ref. 2-29). His investigations indicate that "if a truly elastic material is subjected to a cycle of stress, the stress-strain curve will be a straight line. If, however, the material undergoes reversible plastic deformation during the cycle, the stress-strain curve will be a hysteresis loop. The area enclosed by this loop represents the amount of energy expended during each complete stress cycle. Specimens subjected to cycles of stress below the fatigue limit can dis-

sipate an unlimited quantity of energy as heat without any damage.

"When a solid is subjected to a periodic force, the damping capacity prevents the amplitude of vibration from becoming infinite when the frequency of the applied force approaches a natural frequency of the solid. Damping capacity is of considerable importance in certain branches of engineering and, consistent with other properties, it is generally agreed that materials of high damping capacity are superior to those of low damping capacity. Take, for example, the wings of aeroplanes. Under certain circumstances these are subject to resonant vibrations, the amplitude of which depends essentially on the damping properties of the materials of construction. The same thing applies with special force to the blades of aeroplane propellers which are liable to vibrate violently at certain critical speeds of rotation. The amplitudes of vibra-

tion are great or small according to the material of which the blades are made. It is stated by experts that the endurance of the blades depends far more on the damping capacity of the material than on its fatigue strength."

Damping capacity has been expressed numerically in various ways. Greenhill and Kimball (ref. 2-29, 2-33) have used logarithmic decrement (δ), and Kimball has summarized various formulas used by different investigators for determination of this factor. Briefly, if ΔW is the energy dissipated per cycle of vibration, and W the maximum energy of the cycle, the ratio $\Delta W/W$, called the "specific energy loss" or the "damping capacity," gives a measure of the damping characteristics of the material. The logarithmic decrement δ is equal to one-half the damping capacity, or $\Delta W/2W$.

Values of the logarithmic decrement δ for wood and a few other materials are given in table 2-5.

Table 2-5. Damping capacity—logarithmic decrements (δ) for internal friction in solids

Investigator	Material	Method	Stress-percent of maximum	Logarithmic decrement
Forest Products Laboratory	Wood—Parallel laminated birch	Compression	84	0.002
	do	do	88	.012
	do	do	93	.063
	do	Flexure		.073
Do	Staypak—Yellow birch	Compression	86	.0013
	do	do	89	.0465
	do	do	92	.1435
	do	Flexure		.128
Do	Compreg—Yellow birch, high-impact type	Compression	83	.173
	do	do	89	.232
	do	Flexure		.238
Do	Compreg—Yellow birch, low-impact type	Compression	74	.045
	do	do	87	.157
	do	do	90	.172
	do	Flexure		.108
Do	Compreg—Maple	Compression	89	.0002
	do	do	94	.149
	do	do	93	.218
	do	Flexure		.121
	do	do		.239
Greenhill (Ref. 2-29)	Wood—Sitka spruce	Flexure		.035
	do	Torsion		.0521
Kimball and Lovell (Ref. 2-33).	Wood—Maple	Revolving defl. rods.		.021
	Nickel steel	do		.0023
	Mild steel	do		.0049
	Aluminum	do		.0034
	Nickel	do		.0032
	Celluloid	do		.0450
	Wood	Flexure		.027
A. Gemant W. Jackson (Ref. 2-33)	Nickel steel	do		.0017
	Copper	do		.0032

Data other than those from Greenhill and the Forest Products Laboratory are from a compilation included in reference 2-33.

Greenhill (ref. 2-29) found that the effect of increasing the moisture content of wood is to increase its damping capacity, the relation being practically linear within the range of 8 to 19 percent moisture content examined.

Upon removal of stress, full recovery of strain does not take place in most materials even though the stress imposed may be less than that corresponding to the apparent elastic limit of the material. Tests at the Forest Products Laboratory have shown that, with a compression load applied repeatedly to a specimen of papreg, the set or permanent deformation was increased, but the amount of set added for each load cycle diminished. A straight-line relationship was found when accumulative permanent set was plotted on an arithmetical scale against the number of load cycles plotted on a logarithmic scale. It was found that the higher the load, the greater was the permanent set after the first and all succeeding load cycles.

2.1. Basic Strength and Elastic Properties of Wood

2.10. DESIGN VALUES, TABLES 2-6 AND 2-7. Strength properties of various species for use in calculating the strength of aircraft elements are presented in tables 2-6 and 2-7. Their applicability to the purpose is considered to have been substantiated by experience. The assumptions (see footnotes to tables 2-6 and 2-7) made in deriving the values in tables 2-6 and 2-7 from the results of standard tests (sec. 2.12) have been reexamined in the light of recent data with respect to the distribution of strength values in wood for aircraft construction and the moisture content of airplane parts, together with data relating to "duration of stress" in order to clarify the basis of design (ref. 2-12, 2-13).

The values in table 2-6 are based on a moisture content of 15 percent and are considered applicable for design of structural parts of aircraft that are to be used in the continental United States. Values in table 2-7 are based on a moisture content of 20 percent and should be used for design of structural parts of aircraft to be used under tropical conditions where high relative humidity, approximately 90 percent or over, is prevalent

for long periods of time, or more or less continuously.

When tests of physical properties are made on additional species or on specially selected wood the results may be made comparable to those in tables 2-6 and 2-7 by adjusting them to 15 or 20 percent moisture content, respectively, in accordance with table 2-2, together with the appropriate use of the factors described in the footnotes to tables 2-6 and 2-7.

For notes on acceptable procedures for static tests and the correction of test results, see sections 2.12 and 3.01.

2.100. Supplemental notes.

2.1000. *Compression perpendicular to grain.* Wood does not exhibit a definite ultimate strength in compression perpendicular to the grain, particularly when the load is applied over only a part of the surface, as it is by fittings. Beyond the proportional limit the load continues to increase slowly until the deformation becomes several times as great as at the proportional limit and the crushing is so severe as to damage the wood seriously in other properties. A "probability" factor was applied to average values of stress at proportional limit to take account of variability, and the result was increased by 50 percent to get design values comparable to those for bending, compression parallel to grain, and shear as shown in tables 2-6 and 2-7.

2.1001. *Compression parallel to grain.* Available data indicate that the proportional limit for hardwoods is about 75 percent and for softwoods about 80 percent of the maximum crushing strength. Accordingly, design values for fiber stress at proportional limit were obtained by multiplying maximum crushing-strength values by a factor of 0.75 for hardwoods and 0.80 for softwoods, and adjusting for a difference in the factors for the "rate and duration of load."

2.11. NOTES ON THE USE OF VALUES IN TABLES 2-6 AND 2-7.

2.110. *Relation of design values in tables 2-6 and 2-7 to slope of grain.* The values given in tables 2-6 and 2-7 apply for grain slopes as steep as the following:

- (a) For compression parallel to grain—1 in 12.
- (b) For bending and for tension parallel to grain—1 in 15.

When material is used in which the steepest grain slope is steeper than the above limits, the design values of tables 2-6 and 2-7 must be reduced according to the percentages in table 2-8.

Table 2-6.—Strength values of various woods, based on 15 percent moisture content,¹ to be used in design of aircraft for use in the continental United States (see sections 2.10 and 2.11 for explanations relative to the basis for, and use of, the values in this table)

Species of wood: common and botanical names	Specific gravity based on volume and weight when oven dry		Weight at 15 percent moisture content	Shrinkage from green to oven-dry condition based on dimensions when green		Static bending			Compression parallel to grain			Compression perpendicular to grain ² (F_{c2})	Shearing strength parallel to grain ² (F_{sv})	Hardness side; load required to indented 0.444-inch ball to one-half its diameter etc.	Tension	
	Average ³	Minimum permitted ³		Radial	Tangential	Fiber stress at proportional limit ⁴ (F_p)	Modulus of rupture ⁴ (F_b)	Modulus of elasticity ⁴ (E_t)	Work to maximum load	Fiber stress at proportional limit ⁶ (F_{cp})	Maximum crushing strength ⁴ (F_{cu})				Strength parallel to grain to grain ² (F_{1a})	Strength perpendicular to grain to grain ² (F_{1c})
	(2)	(3)	(4)	(5)	(6)	(7)	(8)	(9)	(10)	(11)	(12)	(13)	(14)	(15)	(16)	(17)
HARDWOODS (BROAD-LEAVED SPECIES)																
Ash, black (<i>Fraxinus nigra</i>)	0.53	0.48	35	5.0	7.8	5,200	10,600	1,310	14.2	3,220	4,600	910	1,190	7.50		320
Ash, commercial white (<i>Fraxinus</i> spp.) ¹⁰	.62	.56	41	4.5	7.2	7,200	13,200	1,400	14.9	4,270	6,100	1,680	1,590	1,180		380
Basswood, American (<i>Tilia glabra</i>)	.40	.36	25	6.6	9.3	4,500	7,700	1,220	6.6	2,680	3,800	450	770	360		170
Beech, American (<i>Fagus grandifolia</i>)	.67	.60	43	5.1	11.0	6,900	13,200	1,480	14.2	4,180	6,000	1,300	1,600	1,170		460
Birch, Alaska (<i>Betula neodaskana</i>)	.59	.53	38	6.5	9.9	6,000	11,800	1,580	13.2	4,070	5,800	850	1,120	780		240
Birch, paper (<i>Betula papyrifera</i>)	.60	.54	38	6.3	8.6	5,300	10,600	1,340	16.1	3,130	4,500	740	980	810		300
Birch (<i>Betula</i> spp.) ¹¹	.68	.58	44	6.8	8.8	7,600	15,100	1,850	18.6	4,500	6,500	1,380	1,630	1,230		280
Cherry, black (<i>Prunus serotina</i>)	.53	.48	36	3.7	7.1	6,900	11,300	1,310	11.7	4,090	5,800	880	1,300	870		300
Cottonwood, Eastern (<i>Populus deltoides</i>)	.43	.39	28	3.9	9.2	4,500	7,700	1,150	7.3	2,770	4,000	400	700	400		270
Elm, American (<i>Ulmus americana</i>)	.55	.50	35	4.2	9.5	6,000	10,600	1,160	12.7	3,220	4,600	880	1,200	770		320
Elm, rock (<i>Ulmus thomasii</i>)	.66	.60	43	4.8	8.1	6,500	13,500	1,310	19.3	4,130	5,900	1,550	1,530	1,210		270
Hickory (true hickories) (<i>Hicoria</i> spp.) ¹²	.80	.71	50	7.4	11.4	8,700	17,100	1,780	26.1	5,080	7,200	2,250	1,600			230
Khaya ("African mahogany") (<i>Khaya</i> spp.) ¹³	.48	.42	32	4.1	5.8	5,800	9,800	1,260	7.9	3,480	5,000	1,320	1,110	720		340
Locust, black (<i>Robinia pseudoacacia</i>)	.71	.64	49	4.4	6.9	10,900	18,100	1,810	17.6	6,300	9,000	2,450	2,010	1,670		360
Magnolia, Southern (<i>Magnolia grandiflora</i>)	.53	.48	35	5.4	6.6	5,500	10,100	1,200	13.4	3,140	4,500	1,100	1,230	940		350
Mahogany (Swietenia spp.) ¹⁴	.52	.46	35	3.5	4.8	6,800	11,700	1,370	7.4	4,330	6,200	1,370	1,060	710		170
Maple, silver (<i>Acer saccharinum</i>)	.51	.46	33	3.0	7.2	4,900	8,100	980	8.9	2,970	4,200	930	1,200	670		260
Maple, sugar (<i>Acer saccharum</i>)	.68	.60	43	4.9	9.5	7,600	14,100	1,590	15.7	4,540	6,500	1,790	1,830	1,310		380
Oak, commercial white and red (<i>Quercus</i> spp.) ¹⁵	.69	.62	44	4.8	9.4	6,000	12,300	1,460	13.2	3,990	5,700	1,450	1,470	1,230		360
Pecan (<i>Hicoria pecan</i>)	.69	.62	46	4.9	8.0	7,400	12,800	1,480	14.0	4,540	6,500	2,120	1,690	1,680		350
Sweetgum (<i>Liquidambar styraciflua</i>) ¹⁶	.54	.48	35	5.2	9.0	6,200	11,200	1,340	10.8	3,380	4,800	770	1,170	640		340
Sycamore, American (<i>Platanus occidentalis</i>)	.54	.49	35	5.1	7.6	5,100	9,100	1,200	8.2	3,160	4,500	800	1,180	730		350
Tupelo, water (<i>Nyssa aquatica</i>)	.52	.47	35	4.2	7.6	5,900	9,100	1,080	7.2	3,520	5,000	1,120	1,310	830		340
Walnut, black (<i>Juglans nigra</i>)	.86	.72	38	5.2	7.1	8,300	13,300	1,460	11.5	4,510	6,400	1,270	1,180	980		330
Yellow-poplar (<i>Liriodendron tulipifera</i>) ¹⁷	.44	.38	29	4.0	7.1	4,000	8,600	1,250	6.4	2,890	4,100	620	930	120		250

See footnotes at end of table.

Table 2-6.—Strength values of various woods, based on 15 percent moisture content,¹ to be used in design of aircraft for use in the continental United States (see sections 2.10 and 2.11 for explanations relative to the basis for, and use of, the values in this table)—Continued

Species of wood: common and botanical names	Specific gravity based on volume and weight when oven dry		Weight at 15 percent moisture content	Shrinkage from green to oven-dry condition based on dimensions when green		Static bending			Compression parallel to grain		Shearing strength parallel to grain ² (F_{sv})	Hardness, side: load required to indent 0.444-inch ball to one-half its diameter	Tension			
	Average ³	Minimum permitted ³		Radial	Tangential	Fiber stress at proportional limit ⁴ (F_{bv})	Modulus of elasticity ⁴ (E_b)	Modulus of rupture ⁴ (F_{br})	Work to maximum load ⁴ (W)	Fiber stress at proportional limit ⁴ (F_{cp})			Maximum crushing strength ⁴ (F_{cw})	Compression perpendicular to grain ⁴ (F_{ct})	Strength parallel to grain (F_{tw})	Strength perpendicular to grain (F_{trt})
(1)	(2)	(3)	(4)	(5)	(6)	(7)	(8)	(9)	(10)	(11)	(12)	(13)	(14)	(15)	(16)	(17)
SOFTWOODS (CONIFERS)																
Baldcypress (<i>Taxodium distichum</i>)	0.48	0.43	Lb. per cu. ft. 32	Percent 3.8	Percent 6.2	P. s. i. 5,900	P. s. i. 9,600	1,000 p. s. i.	W , lb. per cu. ft. 7.7	P. s. i. 4,020	P. s. i. 5,400	P. s. i. 940	P. s. i. 840	Lb. 480	(16)	P. s. i. 140
Cedar, Alaska (<i>Chamaecyparis nootkatensis</i>)	.46	.41	31	2.8	6.0	5,700	9,900	1,220	10.1	3,840	5,100	810	930	540		180
Douglas-fir (normal) (<i>Pseudotsuga taxifolia</i>) ^{12, 16}	.50	.45	33	5.0	7.8	5,900	10,900	1,450	8.1	4,220	5,600	1,020	950	610		140
Douglas-fir (light) ^{12, 16}	.43	.38	28			4,900	9,000	1,210		3,300	4,500	770				
Fir, California red (<i>Abies magnifica</i>)	.42	.38	28	4.5	7.9	5,100	9,400	1,320	8.2	3,480	4,700	680	800	400		190
Fir, noble (<i>Abies nobilis</i>) ¹²	.42	.36	28	4.5	8.3	5,600	9,800	1,470	8.0	3,890	4,800	700	880	380		110
Fir, Pacific (<i>Abies arbutifolia</i>)	.42	.38	27	4.5	10.0	5,000	9,320	1,320	8.3	3,370	4,500	530	800	400		
Fir, white (<i>Abies concolor</i>)	.40	.36	26	3.2	7.0	5,300	8,400	1,170	6.3	3,200	4,400	650	780	410		130
Hemlock, Western (<i>Tsuga heterophylla</i>) ¹²	.45	.40	30	4.3	7.9	6,200	11,000	1,510	7.3	4,080	5,500	730	860	540		150
Incense-cedar, California (<i>Libocedrus decurrens</i>)	.36	.32	25	3.3	5.2	5,000	7,600	900	5.6	3,350	4,500	790	760	450		140
Larch, Western (<i>Larix occidentalis</i>)	.59	.53	37	4.2	8.1	6,700	11,000	1,480	7.8	4,780	6,400	1,150	1,110	680		140
Pine, Eastern white (<i>Pinus strobus</i>)	.37	.34	25	2.1	6.1	4,600	7,600	1,060	6.3	2,960	4,000	520	740	350		150
Pine, ponderosa (<i>Pinus ponderosa</i>)	.42	.33	23	3.9	6.3	5,000	8,100	1,070	6.2	3,160	4,200	750	900	410		100
Pine, red (<i>Pinus resinosa</i>)	.51	.46	33	4.6	7.2	7,000	10,500	1,530	8.7	4,320	5,800	820	970	510		100
Pine, sugar (<i>Pinus lambertiana</i>)	.38	.34	26	2.9	5.6	4,700	7,300	1,020	5.5	2,970	4,000	630	830	360		160
Pine, Western white (<i>Pinus monticola</i>)	.42	.38	28	4.1	7.4	5,000	8,300	1,280	7.7	3,400	4,600	560	700	360		
Redcedar, Western (<i>Thuja plicata</i>)	.34	.31	23	2.4	5.0	4,400	7,100	960	5.6	3,160	4,200	640	720	330		110
Spruce, Sitka (<i>Picea sitchensis</i>) ¹²	.41	.36	28	4.2	7.5	5,300	9,400	1,350	8.7	3,530	4,700	740	900	470		170
Spruce, red (<i>Picea rubra</i>)	.41	.36	28	3.8	7.8	5,600	9,300	1,320	8.1	3,670	4,900	630	800	460		100
Spruce, white (<i>Picea glauca</i>)	.45	.36	29	4.7	8.2	5,100	8,700	1,150	7.2	3,310	4,400	500	850	440		160
White-cedar, Northern (<i>Thuja occidentalis</i>)	.32	.29	22	2.1	4.7	3,900	6,000	690	5.0	2,430	3,300	430	700	200		120
White-cedar, Port Orford (<i>Chamaecyparis lassoniana</i>) ^{12, 16}	.43	.40	29	4.6	6.9	6,700	10,200	1,430	8.6	4,110	5,500	810	790	510		160

Tension strength parallel to grain taken as equal to modulus of rupture. See section 2.11.

¹ A moisture content value of 15 percent has been used in design of wood aircraft for use in the continental United States for many years. This value was substantiated as a normally expected service condition by reference 2-12. For design of aircraft to be used under tropical conditions see table 2-7 and section 2.10.

² Values in column 2 for birch, klaysa, mahogany, sweetgum, yellow-poplar, Douglas-fir, noble fir, Western hemlock, Sitka spruce, and Port Orford white cedar are averages for material having a specific gravity equal to or greater than the minimum permitted for each species, as listed in column 3. For species other than those listed above, values in column 2 are general species averages, without excluding material below the minimum permitted.

³ Values in column 3 for minimum permitted specific gravity are those listed in table 2-3 of AN-C-18, June, 1944, corresponding to applicable Army-Navy-Aeronautical specifications as of that date. The continued applicability of these values is considered as being substantiated by experience.

⁴ The values in columns 7, 8, 9, 12, 13, and 14 are species mean values adjusted to 15 percent moisture content (see footnote 1) and multiplied by two factors: (1) A "probability" factor to allow for variability of wood, and (2) a "rate and duration of load" factor to allow for the effect of estimated loading conditions for aircraft in service. The "probability" factor is based on composite cumulative frequency curves (figs. 1 and 2, ref. 2-13). Factors were determined for each property at an "inclusion" limit of 25 percent; that is, they represent strength values, expressed as percentages of the respective means, below which not more than 25 percent of aircraft-grade material would be expected to fail.

The "rate and duration of load" factors for ultimate are those applicable to a loading time of 1 second and a duration of 1.5 seconds, while those for proportional limits relate to a loading time of 3 seconds and a duration of 15 seconds (data from ref. 2-3). Values for modulus of elasticity in static bending, for compression perpendicular to grain, and for shear are assumed to be unaffected by rate and duration of load. Factors used for the several properties are:

Test	Property	"Probability" Factor	"Rate and Duration of Load" Factor
Static bending	Fiber stress at proportional limit.	0.89	1.05
Static bending	Modulus of rupture	.92	1.10
Static bending	Modulus of elasticity	.91	1.00
Compression parallel to grain	Fiber stress at proportional limit. (See footnote 6).		1.00
Compression parallel to grain	Maximum crushing strength.	.91	1.07
Compression perpendicular to grain	Fiber stress at proportional limit.	.81	1.00
Shear parallel to grain	Maximum shearing strength.	.88	1.00

⁵ The values given in column 9 are based on the average apparent modulus of elasticity (E_c) as obtained by substituting results from tests of 2- by 2-inch beams on a 28-inch span or 1- by 1-inch beams on a 14-inch span with load at the center in the formula $E_c = PL^3/48\delta$. The use of these values of E_c in the usual formulas will give the deflection of beams of ordinary length with but small error. For exactness in the computation of deflections of I and box beams, particularly for short spans, the

formula that takes into account shear deformations (see National Advisory Committee for Aeronautics Report No. 180, ref. 2-59) should be used. This formula involves E_s , the true modulus of elasticity in bending, and G , the modulus of rigidity in shear. Values of E_s may be obtained by adding 10 percent to the values of E_c as given in the table. If the I or box beam has the grain of the web parallel to the axis of the beam, or parallel and perpendicular thereto as in some plywood webs, the value of G may be taken as $E_s/16$ or $E_s/14.5$. If the web is of plywood with the grain at 45° to the axis of the beam G may be taken as $E_s/15$ or $E_s/4.5$.

⁶ Design values for fiber stress at proportional limit in compression parallel to grain were obtained by multiplying the values of maximum crushing strength in the next column by 0.75 for hardwoods and 0.80 for conifers, and by the ratio of the "rate and duration of load" factors, namely, 1.00/1.07.

⁷ Wood does not exhibit a definite ultimate strength in compression perpendicular to grain, particularly when the load is applied over only a part of the surface, as at fittings. Beyond the proportional limit, the load continues to increase slowly until the deformation becomes several times as great as at the proportional limit (see fig. 2-4) and the crushing is so severe as to damage the wood seriously in other properties. In calculating values in column 13, a "rate and duration of load" factor of 1.00 was assumed, and the average proportional limit stress, modified by the appropriate "probability" factor (see footnote 4) was increased by 50 percent to get design values.

⁸ Values in this column are for use in computing resistance to longitudinal shear. They were obtained by multiplying average values by a "probability" factor (see footnote 4) to allow for variability.

⁹ Tests have shown that because of the favorable influence upon the distribution of stresses resulting from limiting shearing deformations the maximum strength-weight ratio and minimum variability in strength are attained when I and box beams are so proportioned that the ultimate shearing strength is not developed and failure by shear does not occur.

¹⁰ Values in column 17 are one-half the average values at 15 percent moisture content.

¹¹ Includes white ash (*F. americana*), green ash (*F. pennsylvanica lanceolata*), and blue ash (*F. quadrangulata*).

¹² Includes sweet birch (*B. lenta*) and yellow birch (*B. lutea*).

¹³ Values for these species in columns 2, 4, 7, 8, 9, 11, 12, and 13 are based on material conforming to aircraft specifications for minimum permitted specific gravity and rings per inch (see footnote 2 and reference 2-13). Values in columns 5, 6, 10, 14, 15, and 17, and all values for other species, are based on general averages for the species without excluding material below the minimum permitted specific gravity or with less than the required number of rings per inch.

¹⁴ Includes shellbark hickory (*H. tinctoria*), mockernut hickory (*H. alba*), pignut hickory (*H. glabra*), and shagbark hickory (*H. ovata*).

¹⁵ Includes only material from Central America.

¹⁶ Includes white oak (*Q. alba*), bur oak (*Q. macrocarpa*), swamp chestnut oak (*Q. prinus*), post oak (*Q. stellata*), Northern red oak (*Q. borealis*), Southern red oak (*Q. rubra*), laurel oak (*Q. laurifolia*), water oak (*Q. nigra*), swamp red oak (*Q. palustris*), willow oak (*Q. phellos*), and yellow oak (*Q. velutina*).

¹⁷ These species will be found in the Army-Navy-Aeronautical specifications under the following names: White-cedar, Port Orford—(AN-C-72) cedar, aircraft Port Orford; Douglas-fir—(AN-F-7) fir, aircraft Douglas; yellow-poplar (AN-P-17) poplar, aircraft yellow.

Table 2-7. Strength values of various woods based on 20 percent moisture content¹ to be used in design of aircraft for use in tropical regions having continued high relative humidity (approximately 90 percent or over) (see sections 2.10 and 2.11 for explanations relative to the basis for, and use of, the values in this table)

Species of wood; common and botanical names	Specific gravity based on volume and weight when oven dry		Weight at 20 percent moisture content	Shrinkage from green to oven-dry condition based on dimensions when green		Static bending				Compression parallel to grain		Compression perpendicular to grain ⁴ (F _{c90})	Shearing strength parallel to grain ⁴ (F _{cs})	Hardness, side load required to imprint 0.444-inch ball to one-half its diameter	Tension	
	Average ²	Minimum permitted ³		Radial	Tangential	Fiber stress at proportional limit ⁵ (F _{sp})	Modulus of rupture (F _{bs})	Modulus of elasticity (E _s)	Work to maximum load	Fiber stress at proportional limit ⁵ (F _{sp})	Max. minimum crushing strength (F _{cs})				Strength parallel to grain (F _{ts})	Strength perpendicular to grain (F _{ts90})
(1)	(2)	(3)	(4)	(5)	(6)	(7)	(8)	(9)	(10)	(11)	(12)	(13)	(14)	(15)	(16)	(17)
HARDWOODS (BROAD-LEAVED SPECIES)																
Ash, black (<i>Fraxinus nigra</i>)	0.53	0.48	35	5.0	7.8	3,400	7,800	1,000	13.0	2,160	3,100	680	930	610		276
Ash, common, white (<i>Fraxinus spp.</i>) ¹⁰	.62	.56	41	4.5	7.2	5,900	11,100	1,310	14.6	3,380	4,800	1,330	1,380	1,050		328
Basswood, American (<i>Thuja glabra</i>)	.40	.36	25	6.0	9.3	3,200	6,100	1,060	5.8	1,060	2,800	330	620	200		152
Beech, American (<i>Fagus grandifolia</i>)	.67	.60	44	5.1	11.0	5,100	10,500	1,350	12.9	3,000	4,400	1,010	1,320	980		402
Birch, Alaska (<i>Betula neolabana</i>)	.59	.53	38	6.5	9.9	4,500	9,000	1,380	12.3	2,800	4,000	650	930	640		146
Birch, paper (<i>Betula papyrifera</i>)	.60	.54	38	6.3	8.6	3,700	8,100	1,180	16.1	2,160	3,100	530	840	660		
Birch (<i>Betula spp.</i>) ¹¹	.68	.58	44	6.8	8.8	5,000	11,900	1,060	17.3	3,330	4,800	1,020	1,320	1,040		284
Cherry, black (<i>Prunus serotina</i>)	.53	.48	30	3.7	7.1	5,100	9,400	1,240	12.3	3,060	4,400	670	1,140	750		284
Cottonwood, Eastern (<i>Populus deltoides</i>)	.43	.30	29	3.9	9.2	3,400	6,300	1,020	7.3	2,010	2,900	370	670	370		230
Elm, American (<i>Ulmus americana</i>)	.55	.50	36	4.2	9.5	4,600	8,600	1,080	12.2	2,470	3,500	670	1,020	680		308
Elm, rock (<i>Ulmus thomasi</i>)	.66	.60	44	4.8	8.1	5,200	11,200	1,180	19.6	3,180	4,500	1,160	1,260	1,060		
Hickory (true hickories) (<i>Hicoria spp.</i>) ¹³	.80	.71	50	7.4	11.4	6,800	13,600	1,550	27.1	3,820	5,500	1,640	1,380			218
Klajava ("African mahogany") (<i>Khaya spp.</i>) ¹²	.48	.42	33	4.1	5.8	5,000	8,700	1,160	8.2	2,970	4,200	1,140	1,090	620		362
Locust, black (<i>Robinia pseudo-acacia</i>)	.71	.64	50	4.4	6.0	9,300	15,700	1,740	16.3	5,330	7,600	2,020	1,740	1,610		362
Magnolia, Southern (<i>Magnolia grandiflora</i>)	.53	.48	36	5.4	6.6	4,200	8,200	1,090	14.5	2,330	3,300	850	1,050	820		326
Mahogany (<i>Swietenia spp.</i>) ¹⁴	.52	.46	36	3.5	4.8	6,000	10,900	1,320	8.6	3,820	5,500	1,150	1,150	700		173
Maple, silver (<i>Acer saccharinum</i>)	.51	.46	34	3.0	7.2	3,700	6,800	910	10.0	2,180	3,100	700	1,040	630		272
Maple, sugar (<i>Acer saccharum</i>)	.68	.60	44	4.9	9.5	5,900	11,400	1,480	14.3	3,440	4,900	1,270	1,510	1,110		
Oak, commercial white and red (<i>Quercus spp.</i>) ¹⁵	.69	.62	45	4.8	9.4	5,300	10,000	1,290	12.1	3,000	4,300	1,170	1,240	1,120		372
Pecan (<i>Hicoria pecan</i>)	.69	.62	46	4.9	8.9	5,900	11,100	1,340	14.3	3,420	4,900	1,520	1,470	1,400		
Sweetgum (<i>Liquidambar styraciflua</i>) ¹²	.54	.48	35	5.2	9.9	4,500	8,900	1,240	10.0	2,510	3,600	600	900	570		206
Sycamore, American (<i>Platanus occidentalis</i>)	.54	.49	35	5.1	7.6	3,800	7,600	1,040	7.8	2,450	3,500	680	1,000	690		330
Tupelo, water (<i>Nyssa aquatica</i>)	.52	.47	35	4.2	7.6	4,700	8,100	1,010	7.8	2,790	4,000	850	1,160	760		316
Walnut, black (<i>Juglans nigra</i>)	.56	.52	39	5.2	7.1	6,300	11,100	1,360	13.2	3,550	5,100	930	1,120	930		304
Yellow-poplar (<i>Liriodendron tulipifera</i>) ¹²	.44	.38	30	4.0	7.1	3,600	6,900	1,100	5.9	2,070	3,000	490	700	370		207

equal to modulus of rupture. See sec. 2.11.

SOFT WOODS (CONIFERS)

.48	.43	33	3.8	6.2	4,700	7,900	1,150	7.1	3,170	4,200	740	770	430	146
Baldypress (<i>Taxodium distichum</i>)														
.46	.41	32	2.8	6.0	4,400	7,000	1,110	9.6	2,840	3,800	640	820	490	169
Cedar, Alaska (<i>Chamaecyparis nootkatensis</i>)														
.50	.45	34	5.0	7.8	4,700	9,100	1,350	7.4	3,230	4,300	800	870	530	130
Douglas-fir (normal) (<i>Pseudotsuga taxifolia</i>) ¹⁰														
.43	.38	29			4,000	7,500	1,110		2,580	3,500	600			
Douglas-fir (light) ¹⁰														
.42	.38	20	4.5	7.9	3,000	7,400	1,190	7.1	2,610	3,500	530	780	400	100
Fir, California red (<i>Abies magnifica</i>)														
.42	.36	28	4.5	8.3	4,300	7,800	1,340	6.8	2,670	3,400	530	700	320	114
Fir, noble (<i>Abies nobilis</i>) ¹²														
.42	.38	27	4.5	10.0	4,000	6,800	1,220	6.9	2,490	3,300	420	690	350	
Fir, Pacific silver (<i>Abies amabilis</i>)														
.40	.36	27	3.2	7.0	4,300	6,800	1,040	5.6	2,480	3,300	530	710	370	140
Fir, white (<i>Abies concolor</i>)														
.45	.40	30	4.3	7.9	4,300	9,400	1,410	7.1	3,100	4,300	610	760	490	154
Hemlock, Western (<i>Tsuga heterophylla</i>) ¹²														
.36	.32	26	3.3	5.2	4,200	6,900	820	6.0	2,720	3,600	650	750	410	140
Incense-cedar, California (<i>Libocedrus decurrens</i>)														
.50	.53	38	4.2	8.1	5,000	9,500	1,360	7.5	3,810	5,100	930	970	580	131
Larch, Western (<i>Larix occidentalis</i>)														
.37	.34	26	2.1	6.1	3,500	6,000	970	5.7	2,240	3,000	300	680	320	135
Pine, Eastern white (<i>Pinus strobus</i>)														
.42	.38	29	3.9	6.3	3,700	6,300	960	5.6	2,280	3,000	550	720	350	162
Pine, ponderosa (<i>Pinus ponderosa</i>)														
.51	.46	34	4.6	7.2	4,800	8,200	1,370	7.0	3,000	4,000	580	860	410	131
Pine, red (<i>Pinus resinosa</i>)														
.38	.34	27	2.9	5.6	3,800	6,000	920	5.4	2,200	3,100	510	600	330	148
Pine, sugar (<i>Pinus lambertiana</i>)														
.42	.38	28	4.1	7.4	3,900	6,500	1,150	6.1	2,480	3,300	440	620	310	
Pine, Western white (<i>Pinus monticola</i>)														
.31	.31	24	2.4	5.0	3,500	6,000	800	5.3	2,450	3,300	500	670	290	114
Redcedar, Western (<i>Thuja plicata</i>)														
.41	.36	28	4.2	7.5	4,200	7,700	1,270	7.6	2,760	3,700	580	860	420	151
Spruce, Sitka (<i>Picea sitchensis</i>) ¹²														
.41	.36	29	3.8	7.8	4,400	7,700	1,210	7.5	2,810	3,800	530	790	410	135
Spruce, red (<i>Picea rubra</i>)														
.45	.36	29	4.7	8.2	3,900	6,000	1,040	6.5	2,420	3,200	440	710	370	128
Spruce, white (<i>Picea glauca</i>)														
.32	.29	22	2.1	4.7	3,000	5,000	630	5.4	1,800	2,400	380	610	250	120
White-cedar, Northern (<i>Thuja occidentalis</i>)														
.43	.40	30	4.6	6.9	5,100	7,000	1,320	7.9	3,040	4,100	580	710	440	116
White-cedar, Port Orford (<i>Chamaecyparis lawsoniana</i>) ¹²														

Tension strength parallel to grain taken as

See footnotes on page 26.

¹ A moisture content value of 20 percent has been used in determining the values in table 2-7. This moisture content represents an equilibrium with high relative humidity, approximately 90 percent or over, corresponding to conditions in tropical areas where high humidity is prevalent for long periods of time, or more or less continuously. For design of aircraft to be used within the continental United States see table 2-6 and section 2.10.

² Values in column 2 for birch, khaya, mahogany, sweetgum, yellow-poplar, Douglas-fir, noble fir, Western hemlock, Sitka spruce, and Port Orford white-cedar are averages for material having a specific gravity equal to or greater than the minimum permitted for each species, as listed in column 3. For species other than those listed above, values in column 2 are general species averages, without excluding material below the minimum permitted.

³ Values in column 3 for minimum permitted specific gravity are those listed in table 2-3 of ANO-18, June, 1944, corresponding to applicable Army-Navy-Aeronautical specifications as of that date. The continued applicability of these values is considered as being substantiated by experience.

⁴ The values in columns 7, 8, 9, 12, 13, and 14 are species mean values adjusted to 20 percent moisture content (see footnote 1) and multiplied by two factors: (1) A "probability" factor to allow for variability of wood, and (2) a "rate and duration of load" factor to allow for the effect of estimated loading conditions for aircraft in service. The "probability" factor is based on composite cumulative frequency curves (figs. 1 and 2, ref. 2-13). Factors were determined for each property at an "inclusion" limit of 25 percent; that is, they represent strength values, expressed as percentages of the respective means, below which not more than 25 percent of aircraft-grade material would be expected to fail.

The "rate and duration of load" factors for ultimates are those applicable to a loading time of 3 seconds and a duration of 1.5 seconds, while those for proportional limits relate to a loading time of 3 seconds and a duration of 15 seconds (data from ref. 2-3). Values for modulus of elasticity in static bending, for compression perpendicular to grain, and for shear are assumed to be unaffected by rate and duration of load. Factors used for the several properties are:

Test	Property	"Probability" Factor	"Rate and Duration of Load" Factor
Static bending	Fiber stress at proportional limit	0.89	1.05
Static bending	Modulus of rupture	.92	1.10
Static bending	Modulus of elasticity	.91	1.00
Compression parallel to grain	Fiber stress at proportional limit	(See footnote 6)	1.00
Compression parallel to grain	Maximum crushing strength	.91	1.07
Compression perpendicular to grain	Fiber stress at proportional limit	.81	1.00
Shear parallel to grain	Maximum shearing strength	.88	1.00

⁵ The values given in column 9 are based on the average apparent modulus of elasticity (E_a) as obtained by substituting results from tests of 2- by 2-inch beams on a 28-inch span or 1- by 1-inch beams on a 14-inch span with load at the center in the formula $E_a = PL^3/48\delta$. The use of these values of E_a in the usual formulas will give the deflection of beams of ordinary length with but small error.

For exactness in the computation of deflections of I and box beams, particularly for short spans, the formula that takes into account shear deformations (see National Advisory Committee for Aeronautics Report No. 180, ref. 2-50) should be used. This formula involves I_s , the true modulus of elasticity in bending, and G , the modulus of rigidity in shear. Values of E_s may be obtained by adding 10 percent to the values of E_x as given in the table. If the I or box beam has the grain of the web parallel to the axis of the beam, or parallel and perpendicular thereto as in some plywood webs, the value of G may be taken as $E_s/16$ or $E_s/14.5$. If the web is of plywood with the grain at 45° to the axis of the beam G may be taken as $E_s/15$ or $E_s/14.5$.

⁶ Design values for fiber stress at proportional limit in compression parallel to grain were obtained by multiplying the values of maximum crushing strength in the next column by 0.75 for hardwoods and 0.80 for conifers, and by the ratio of the "rate and duration of load" factors, namely, 1.00/1.07.

⁷ Wood does not exhibit a definite ultimate strength in compression perpendicular to grain, particularly when the load is applied over only a part of the surface, as at fittings. Beyond the proportional limit, the load continues to increase slowly until the deformation becomes several times as great as at the proportional limit (see figure 2-4) and the crushing is so severe as to damage the wood seriously in other properties. In calculating values in column 13, a "rate and duration of load" factor of 1.00 was assumed, and the average proportional limit stress, modified by the appropriate "probability" factor (see footnote 4) was increased by 50 percent to get design values.

⁸ Values in this column are for use in computing resistance to longitudinal shear. They were obtained by multiplying average values by a "probability" factor (see footnote 4) to allow for variability. Tests have shown that because of the favorable influence upon the distribution of stresses resulting from limiting shearing deformations the maximum strength-weight ratio and minimum variability in strength are attained when I and box beams are so proportioned that the ultimate shearing strength is not developed and failure by shear does not occur.

⁹ Values in column 17 are one-half the average values at 20 percent moisture content.

¹⁰ Includes white ash (*F. americana*), green ash (*F. pennsylvanica lanceolata*), and blue ash (*F. quadrangulata*).

¹¹ Includes sweet birch (*B. lenta*) and yellow birch (*B. lutea*).

¹² Values for these species in columns 2, 4, 7, 8, 9, 11, 12, and 13 are based on material conforming to aircraft specifications for minimum permitted specific gravity and rings per inch (see footnote 2 and ref. 2-13). Values in columns 5, 6, 10, 11, 15, and 17, and all values for other species, are based on general averages for the species without excluding material below the minimum permitted specific gravity or with less than the required number of rings per inch.

¹³ Includes shefbark hickory (*H. incisa*), mockernut hickory (*H. alba*), pignut hickory (*H. glabra*), and shagbark hickory (*H. ovata*).

¹⁴ Includes only material from Central America.

¹⁵ Includes white oak (*Q. alba*), bur oak (*Q. macrocarpa*), swamp chestnut oak (*Q. prinus*), post oak (*Q. stellata*), Northern red oak (*Q. borealis*), Southern red oak (*Q. rubra*), laurel oak (*Q. laurifolia*), water oak (*Q. nigra*), swamp red oak (*Q. paludosa*), willow oak (*Q. phellos*), and yellow oak (*Q. retume*).

¹⁶ These species will be found in the Army-Navy-Aeronautical specifications under the following names: White-cedar, Port Orford—(AN-C-72) cedar, aircraft Port Orford; Douglas-fir (AN-F-7) fir, aircraft Douglas; yellow-poplar (AN-F-17) poplar, aircraft yellow.

2.111. *Tension parallel to grain.* Relatively few data are available on the tensile strength of various species parallel to grain. In the absence of sufficient tensile-test data upon which to base tension design values, the values used in design for modulus of rupture are used also for tension. While it is recognized that this is somewhat conservative, the pronounced effect of stress concentration, slope of grain (table 2-8) and other factors upon tensile strength makes the use of conservative values desirable.

Pending further investigation of the effects of stress concentration at bolt holes, it is recommended that the stress in the area remaining to resist tension at the critical section through a bolt hole not exceed two-thirds the modulus of rupture in static bending when cross-banded reinforcing plates are used; otherwise one-half the modulus of rupture shall not be exceeded.

2.112. *Tension perpendicular to grain.* Values of strength of various species in tension perpendicular to grain have been included for use as a guide in estimating the adequacy of glued joints subjected to such stresses. For example, the joints between the upper wing skin and wing framework are subjected to tensile stresses perpendicular to the grain by reason of the lift forces exerted on the upper skin surface.

Caution must be exercised in the use of these values, since little experience is available to serve as a guide in relating these design values to the average property. Considering the variability of this property, however, the possible discontinuity or lack of uniformity of glue joints, and the probable concentration of stress along the edges of such joints, the average test values for each species have been multiplied by a factor of 0.5 to obtain the values given in tables 2-6 and 2-7.

Table 2-8. Reduction in wood strength for various grain slopes

Maximum slope of grain in the member	Corresponding design value, percent of value in table 2-6				
	Static bending			Compression parallel to grain	Tension parallel to grain
	Fiber stress at proportional limit	Modulus of rupture	Modulus of elasticity		
			Maximum crushing strength	Modulus of rupture	
1 in 15	100	100	100		100
1 in 12	98	88	97	100	85
1 in 10	87	78	91	98	75
1 in 8	78	67	84	94	60

2.12. STANDARD TEST PROCEDURES.

2.120. *Static bending.* In the static-bending test, the resistance of a beam to slowly applied loads is measured. The beam is 2 by 2 inches in cross section and 30 inches long and is supported on roller bearings which rest on knife edges 28 inches apart. Load is applied at the center of the length through a hard maple block $3\frac{1}{8}$ inches wide, having a compound curvature. The curvature has a radius of 3 inches over the central $2\frac{1}{2}$ inches of arc, and is joined by an arc of 2-inch radius on each side. The standard placement is with the annual rings of the specimen horizontal and the loading block bearing on the side of the piece nearest the pith. A constant rate of deflection (0.1 inch per minute) is maintained until the specimen fails. Load and deflection are read simultaneously at suitable intervals.

Figure 2-4 (a) shows a static-bending test set-up, and typical load-deflection curves for Sitka spruce and yellow birch.

Data on a number of properties are obtained from this test. These are discussed as follows:

2.1200. *Modulus of elasticity (E_L).* The modulus of elasticity is determined from the slope of the straight line portion of the graph, the steeper the line, the higher being the modulus. Modulus of elasticity is computed by

$$E_L = \frac{P_p L^3}{48 \delta_p I} = \frac{P_p L^3}{4 \delta_p b d^3} \quad (2:5)$$

The standard static bending test is made under such conditions that shear deformations are responsible for approximately 10 percent of the deflection. Values of E_L from tests made under such conditions and calculated by the formula shown do not, therefore, represent the true modulus of elasticity of the material, but an "apparent" modulus of elasticity.

The use of these values of apparent modulus of elasticity in the usual formulas will give the deflection of simple beams of ordinary length with but little error. For I- and box beams, where more exact computations are desired, and formulas are used that take into account the effect of shear deformations, a "true" value of the modulus of elasticity is necessary and may be had by adding 10 percent to the values in tables 2-6 and 2-7.

2.1201. *Fiber stress at proportional limit (F_{bp}).* The plotted points from which the early portions of the curves of figure 2-4 (a) were drawn lie approximately on a straight line, showing that the

deflection is proportional to the load. As the test progresses however, this proportionality between load and deflection ceases to exist. The

point at which this occurs is known as the proportional limit. The corresponding stress in the extreme fibers of the beam is known as "fiber stress at proportional limit." Fiber stress at proportional limit is computed by

$$F_{bp} = \frac{P_p L c}{4 I} = \frac{1.5 P_p L}{b d^2} \quad (2:6)$$

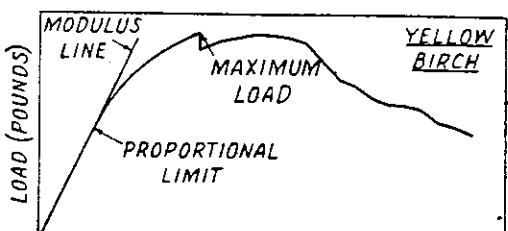
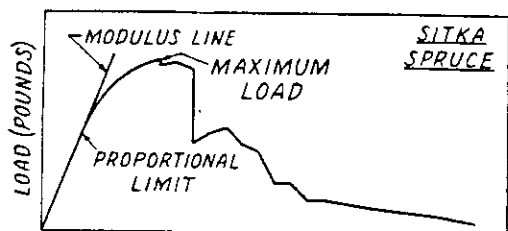

(a) STATIC BENDING

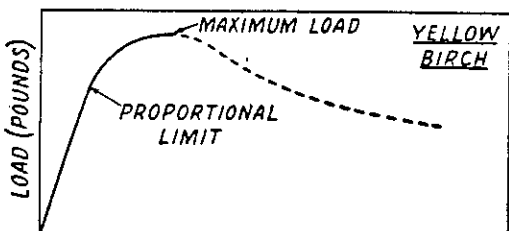
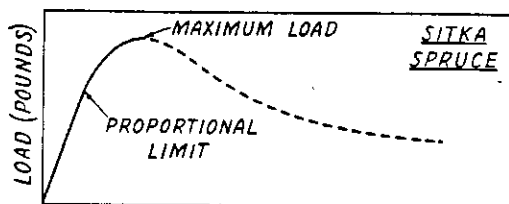

(b) COMPRESSION PARALLEL TO GRAIN

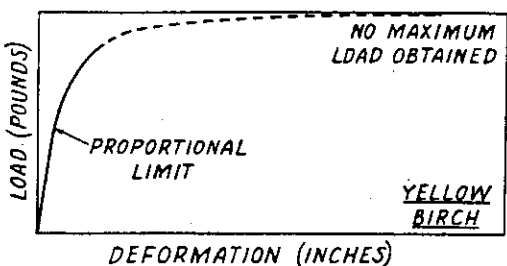
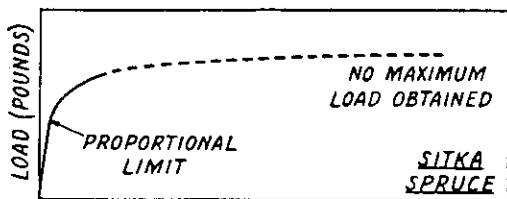

(c) COMPRESSION PERPENDICULAR TO GRAIN

Figure 2-4. Standard test methods and typical load-deflection curves

2.1202. *Modulus of rupture (F_{bu})*. Modulus of rupture is computed by the same formula as was used in computing fiber stress at proportional limit, except that maximum load is used in place of load at proportional limit. Since the formula used is based upon an assumption of linear variation of stress across the cross section of the beam, modulus of rupture is not truly a stress existing at time of rupture, but is useful in finding the load-carrying capacity of a beam.

2.1203. *Work to maximum load*. The energy absorbed by the specimen up to the maximum load is represented by the area under the load-deflection curve from the origin to a vertical line through the abscissa representing the maximum deflection at which the maximum load is sustained. It is expressed, in tables 2-6 and 2-7, in inch-pounds per cubic inch of specimen. Work to maximum load is computed by

$$\text{Work to } P_{\max} = \frac{\text{area under curve to } P_{\max}}{b \times d \times L} \quad (2:7)$$

2.121. *Compression parallel to grain*. In the compression-parallel-to-grain test, a 2- by 2- by 8-inch block is compressed in the direction of its length at a constant rate (0.024 inch per minute). The load is applied through a spherical bearing block, preferably of the suspended self-aligning type, to insure uniform distribution stress. On some of the specimens, the load and the deformation in a 6-inch central gage length are read simultaneously until the proportional limit is passed. The test is discontinued when the maximum load is passed and the failure appears.

Figure 2-4 (b) shows a test set-up, and typical load-deflection curves for Sitka spruce and yellow birch. Data on a number of properties are obtained from this test. These are discussed as follows:

2.1210. *Modulus of elasticity (E_{Lc})*. The modulus of elasticity is determined from the slope of the straight-line portion of the graph, the steeper

the line the higher the modulus. The modulus of elasticity is computed by

$$E_{Lc} = \frac{P_p}{Ae_L} \quad (2:8)$$

The value of the modulus of elasticity so determined corresponds to the "true" value of modulus of elasticity discussed under static bending. Values of the modulus of elasticity from compression-parallel-to-grain tests are not published but may be approximated by adding 10 percent to the apparent values shown under static bending in table 2-6.

A multiplying factor of 1.1 has been inserted in various formulas throughout this bulletin to convert E_L values, as shown in tables 2-6 and 2-7 to E_{Lc} values required in formulas involving direct stress.

2.1211. *Fiber stress at proportional limit (F_{cp})*. The plotted points from which early portions of the curves of figure 2-4 (b) were drawn lie approximately on a straight line, showing that the deformation within the gage length is proportional to the load. The point at which this proportionality ceases to exist is known as the proportional limit and the stress corresponding to the load at proportional limit is the fiber stress at proportional limit. It is calculated by

$$F_{cp} = \frac{P_p}{A} \quad (2:9)$$

2.1212. *Maximum crushing strength (F_{cu})*. The maximum crushing strength is computed by the same formula as used in computing fiber stress at proportional limit except that maximum load is used in place of load at proportional limit.

2.122. *Compression perpendicular to grain*. The specimen for the compression-perpendicular-to-grain test is 2 by 2 inches in cross section and 6 inches long. Pressure is applied through a steel plate 2 inches wide placed across the center of the specimen and at right angles to its length. Hence, the plate covers one-third of the surface. The standard placement of the specimen is with the growth rings vertical. The standard rate of descent of the movable head is 0.024 inch per minute. Simultaneous readings of load and compression are taken until the test is discontinued at 0.1-inch compression.

Figure 2-4 (c) shows a test set-up, and typical load-deflection curves for Sitka spruce and yellow birch.

The principal property determined is the stress at proportional limit (F_{cp}) which is calculated by

$$F_{cp} = \frac{\text{Load at proportional limit}}{\text{Width of plate} \times \text{width of specimen}} \quad (2:10)$$

Tests indicate that the stress at proportional limit when the growth rings are placed horizontal does not differ greatly from that when the growth rings are vertical. For design purposes, therefore, the values of strength in compression perpendicular to grain as given in tables 2-6 and 2-7 may be used regardless of ring placement.

2.123. *Shear parallel to grain (F_{su})*. The shear-parallel-to-grain test is made by applying force to a 2- by 2-inch lip projecting $\frac{3}{4}$ inch from a block $2\frac{1}{2}$ inches long. The block is placed in a special tool having a plate that is seated on the lip and moved downward at a rate of 0.015 inch per minute. The specimen is supported at the base so that a $\frac{1}{8}$ -inch offset exists between the outer edge of the support and the inner edge of the loading plate.

The shear tool has an adjustable seat in the plate to insure uniform lateral distribution of the load. Specimens are so cut that a radial surface of failure is obtained in some and a tangential surface of failure in others.

The property obtained from the test is the maximum shearing strength parallel to grain. It is computed by

$$F_{su} = \frac{P_{maz}}{A} \quad (2:11)$$

The value of F_{su} as found when the surface of failure is in a tangential plane does not differ greatly from that found when the surface of failure is in a radial plane, and the two values have been combined to give the values shown in column 14 of tables 2-6 and 2-7.

2.124. *Hardness*. Hardness is measured by the load required to embed a 0.444-inch ball to one-half its diameter in the wood. (The diameter of the ball is such that its projected area is one square centimeter.) The rate of penetration of the ball is 0.25 inch per minute. Two penetrations are made on each end, two on a radial, and two on a tangential surface of the specimen. A special tool makes it easy to determine when the proper penetration of the ball has been reached. The accompanying load is recorded as the hardness value.

Values of radial and tangential hardness as

Table 2-9. Elastic constants of various species

Species	Specific gravity ¹	Moisture content ¹	Young's modulus ratios		Modulus of rigidity ratios			Poisson's ratios					Source of data	
			E_r/E_L	E_r/E_L	G_{LR}/E_L	G_{LT}/E_L	G_{RT}/E_L	μ_{LR}	μ_{LT}	μ_{RT}	μ_{TR}	μ_{RL}		μ_{TL}
Balsa ²	0.131	9.4	0.015	0.046	0.054	0.037	0.005	0.229	0.488	0.665	0.231	0.018	0.009	Reference 2-3.
Douglas-fir	.506	7.5	.061	.090				.295	.441	.447	.368	.030	.023	Reference 2-26.
Do	.506	12.9	.050	.068				.292	.449	.390	.374	.036	.029	Do.
Do	.506	19.9	.032	.056				.274	.496	.560	.396	.018	.019	Do.
Do	.45	11.2			.064	.078	.007							Reference 2-4.
Khaya	.45	11.3	.050	.111	.088	.059	.021	.297	.641	.604	.264	.033	.032	Reference 2-2.
Mahogany	.50	11.7	.064	.107	.086	.066	.028	.314	.533	.600	.326	.033	.034	Reference 2-2.
Quipo ³	.137	11.2	.055	.182	.082	.055	.032	.216	.666	.455	.128	.047	.032	Reference 2-3.
Sitka spruce	.378	7.1	.050	.089				.375	.436	.468	.248	.034	.022	Reference 2-10.
Do	.378	12.8	.043	.078				.372	.467	.435	.245	.040	.025	Do.
Do	.378	16.3	.036	.064				.374	.504	.527	.278	.030	.020	Do.
Do	.378	21.6	.029	.053				.371	.539	.512	.278	.022	.017	Do.
Do	.39	6.8			.070	.068	.004							Reference 2-5.
Do	.39	11.1			.064	.061	.003							Do.
Sweetgum	.536	11.2	.050	.115				.325	.403	.682	.309	.044	.023	Reference 2-25.
Do	.530	10.2			.089	.061	.021							Reference 11.
Yellow birch	.64	13.3	.050	.078				.426	.451	.697	.426	.043	.024	Reference 11.
Do	.65	12.6			.074	.068	.017							Do.
Yellow-poplar	.376	10.7	.043	.092	.075	.069	.011	.318	.392	.703	.329	.030	.019	Reference 2-12.
Ash	.801	13.6	.064	.109	.057	.041	.0165	.533	.653	.656	.386	.0582	.0421	Reference 2-21.
Walnut	.593	11.0	.056	.106	.085	.062	.0209	.495	.632	.718	.367	.0520	.0360	Do.

¹ Specific gravity based on volume at test and weight when oven dry. The values shown to 2 decimal places, and corresponding moisture values, are tentative, and subject to revision.

² The balsa in these tests varied in specific gravity from 0.06 to 0.22, in which range E_L is given approximately by the equation $E_L = 5,500,000 \times \text{specific gravity} - 200,000$.

³ The quipo in these tests varied in specific gravity from 0.08 to 0.20, in which range E_L is given approximately by the equation $E_L = 3,260,000 \times \text{specific gravity} - 170,000$.

determined by the standard test have been averaged to give the values of side hardness in tables 2-6 and 2-7.

2.125. *Tension perpendicular to grain* (F_{tuT}). The tension-perpendicular-to-grain test is made to determine the resistance of wood across the grain to slowly applied tensile loads. The test specimen is 2 by 2 inches in cross section, and 2½ inches in overall length, with a length at midheight of 1 inch. The load is applied with special grips, the rate of movement of the movable head of the testing machine being 0.25 inch per minute. Some specimens are cut to give a radial and others to give a tangential surface of failure.

The only property obtained from this test is the maximum tensile strength perpendicular to grain. It is calculated from the formula

$$F_{tuT} = \frac{P_{max.}}{A} \quad (2:12)$$

Tests indicate that the plane of failure being tangential or radial makes little difference in the strength in tension perpendicular to grain. Results from both types of specimens have, therefore, been combined to give the values shown in tables 2-6 and 2-7.

2.13. ELASTIC PROPERTIES NOT INCLUDED IN TABLES 2-6 AND 2-7. Certain elastic properties useful in design are not included in tables 2-6 and 2-7. The data in tables 2-6 and 2-7 are, in general, based on large numbers of tests, while the data on the additional elastic properties are based on relatively few tests. Available data on these properties are included in table 2-9.

2.130. *Moduli of elasticity perpendicular to grain* (E_T , E_R). The modulus of elasticity of wood perpendicular to the grain is designated as E_T when the direction is tangential to the annual growth rings, and E_R when the direction is radial to the annual growth rings. Tests have been made to evaluate these elastic properties for only a few species (table 2-9). The ratios $\frac{E_T}{E_L}$ and $\frac{E_R}{E_L}$ vary greatly among species and are considerably affected by differences in specific gravity and moisture content. For species not listed in the table, a rough approximation of the values for E_T and E_R may be made by assuming values of $\frac{E_T}{E_L}$ and $\frac{E_R}{E_L}$ as 0.05 and 0.10, respectively. Values of E_L are given in tables 2-6 and 2-7.

2.131. *Moduli of rigidity* (G_{LT} , G_{LR} , G_{RT}). The modulus of elasticity in shear, or the modulus of

rigidity as it is called, must be associated with shear deformation in one of the three mutually perpendicular planes defined by the L , T , and R directions, and with shear stresses in the other two. The symbol for modulus of rigidity has subscripts denoting the plane of deformation. Thus the modulus of rigidity G_{LT} refers to shear deformations in the LT plane resulting from shear stresses in the LR and RT planes. Values of these moduli for a few species are given in table 2-9. The ratios of G_{LT} , G_R , and G_{RT} to E_L vary among species and appear to be considerably affected by differences in specific gravity and moisture content. For species not listed in the table, it is recommended the approximate ratios $\frac{G_{LT}}{E_L} = 0.06$, $\frac{G_{LR}}{E_L} = 0.075$, and $\frac{G_{RT}}{E_L} = 0.018$ be used in evaluating the various moduli of rigidity. The two letters of the subscript may be interchanged without changing the meaning of G .

2.132. *Poisson's ratios* (μ). The Poisson's ratio relating to the contraction in the T direction under a tensile stress acting in the L direction, and thus normal to the RT plane, is designated as μ_{LT} ; μ_{LR} , μ_{RT} , μ_{RL} , μ_{TR} , and μ_{TL} have similar significance, the first letter of the subscript in each relating to the direction of stress and the second to the direction of the lateral deformation.

Thus, the two letters of the subscript may not be interchanged without changing the meaning. The Poisson's ratios appear to be independent of specific gravity but are variously affected by differences in moisture content. Information on Poisson's ratios for wood is meager and values for only a few species are given in table 2-9.

2.14. STRESS-STRAIN RELATIONS. For most practical purposes wood can be considered to be an orthotropic material having orthotropic axes L , T , and R (see sec. 2.00). If the directions of the applied stresses are parallel to a plane containing two of these axes, the methods described in sections 2.56 to 2.5602, inclusive, can be applied. The general equations for stresses applied in any direction can be obtained from reference 2-53.

2.15. STRENGTH UNDER MULTIAXIAL STRESS. If the directions of the applied stresses are parallel to a plane containing two of the orthotropic axes, the methods described in section 2.610 to 2.613, inclusive, for plywood can be applied. The ultimate shear stress associated with relative shear displacements of the L and R axes and the L and T axes are each equal to the ultimate shear stress

parallel to the grain (F_{su}). The ultimate shear stress associated with relative shear displacements of the R and T axes is for hardwoods approximately one-half and for coniferous woods one-third of F_{su} (ref. 2-48). The ultimate compressive stress

associated with the T and R axes are each equal to the compressive strength perpendicular to the grain (F_{cut}) and the ultimate tensile stress associated with these axes are each equal to the tensile strength perpendicular to the grain (F_{tuT}).

The general equation defining the condition of failure for stresses applied in any direction is similar to equation (2:51) except that its left hand member contains six terms instead of three. If the ultimate stresses are given the values indicated in the preceding paragraph this equation can be written in the following form:

$$\left(\frac{f_L}{F_L}\right)^2 + \left(\frac{f_T}{F_T}\right)^2 + \left(\frac{f_R}{F_R}\right)^2 + \frac{(f_{LT})^2 + (f_{LR})^2 + (Kf_{RT})^2}{(F_{su})^2} = 1 \quad (2:13)$$

in which f_L , f_T , and f_R are the three internal direct stresses in the directions of the axes L , T , and R , respectively, and f_{LT} , f_{LR} , and f_{RT} are the three internal shear stresses associated with shear displacements of the L and T axes, the L and R axes, and the R and T axes, respectively. Also F_L , F_T , and F_R are the three ultimate stresses associated with the directions of the L , T , and R axes, respectively, and may be tensile or compressive; thus F_L is tensile if f_L is tensile and compressive if f_L is compressive and similarly for F_T and F_R . Thus F_L is equal to F_{cu} or F_{tu} ; F_T is equal to F_{cut} or F_{tuT} ; and F_R is equal to F_{cut} or F_{tuT} . The value of K is 2 for hardwoods and 3 for coniferous woods.

Equation (2:13) can be handled in the manner described in section 2.613 and in reference 2-67 using the transformation equations for three dimensions given in reference 2-53.

The methods described in this section have not been verified by test but their verification for plywood indicates that they probably will yield reasonable values. Also equation 2:44 has been compared with results of tests on solid wood in which the specimens were constrained by the testing equipment and good agreement was found, however, shear stress associated with relative shear displacements of the R and T axes was not involved in these tests.

2.16. STRESS CONCENTRATIONS. Wood has

plastic as well as elastic properties (see sec. 2.06 on creep) and, therefore, stress concentrations in tension, compression, or shear are greatly relieved with the passage of time. In compression and shear, creep is very rapid for stresses near the ultimate value and, therefore, values of stress concentration calculated by means of the mathematical theory of elasticity are rarely attained. Creep at high stress in tension, however, is not nearly so rapid and calculated values of stress concentration may be approximately correct if the load is suddenly applied. This fact should be given careful consideration in the design of wood and plywood tension members, and stress concentrations should be avoided.

2.161. *Stress concentrations around a hole in a tension or compression member.* Figure 2-5 shows a panel of wood pierced by an elliptical hole which is small compared to the size of the panel. Axes y and z are orthotropic axes of the wood as well as axes of the ellipse. When a tensile stress (f_a) is applied as shown in the figure, tensile stress concentrations occur at the ends of axis a . The value of the stress at these points is given by equation (2:14):

$$f = f_a \left(\frac{a}{b} \sqrt{\frac{E_y}{G_{yz}} - 2\mu_{yz}} + 2 \sqrt{\frac{E_y}{E_z}} + 1 \right) \quad (2:14)$$

in which f_a denotes the value of the applied stress, subscript y denotes the orthotropic axis which is parallel to the stress, and subscript z denotes the other orthotropic axis which lies in the plane of the panel. These subscripts may represent the L , T , or R directions depending upon the directions of the grain and annual rings in the panel. Equation (2:14) applies also to a compressive stress.

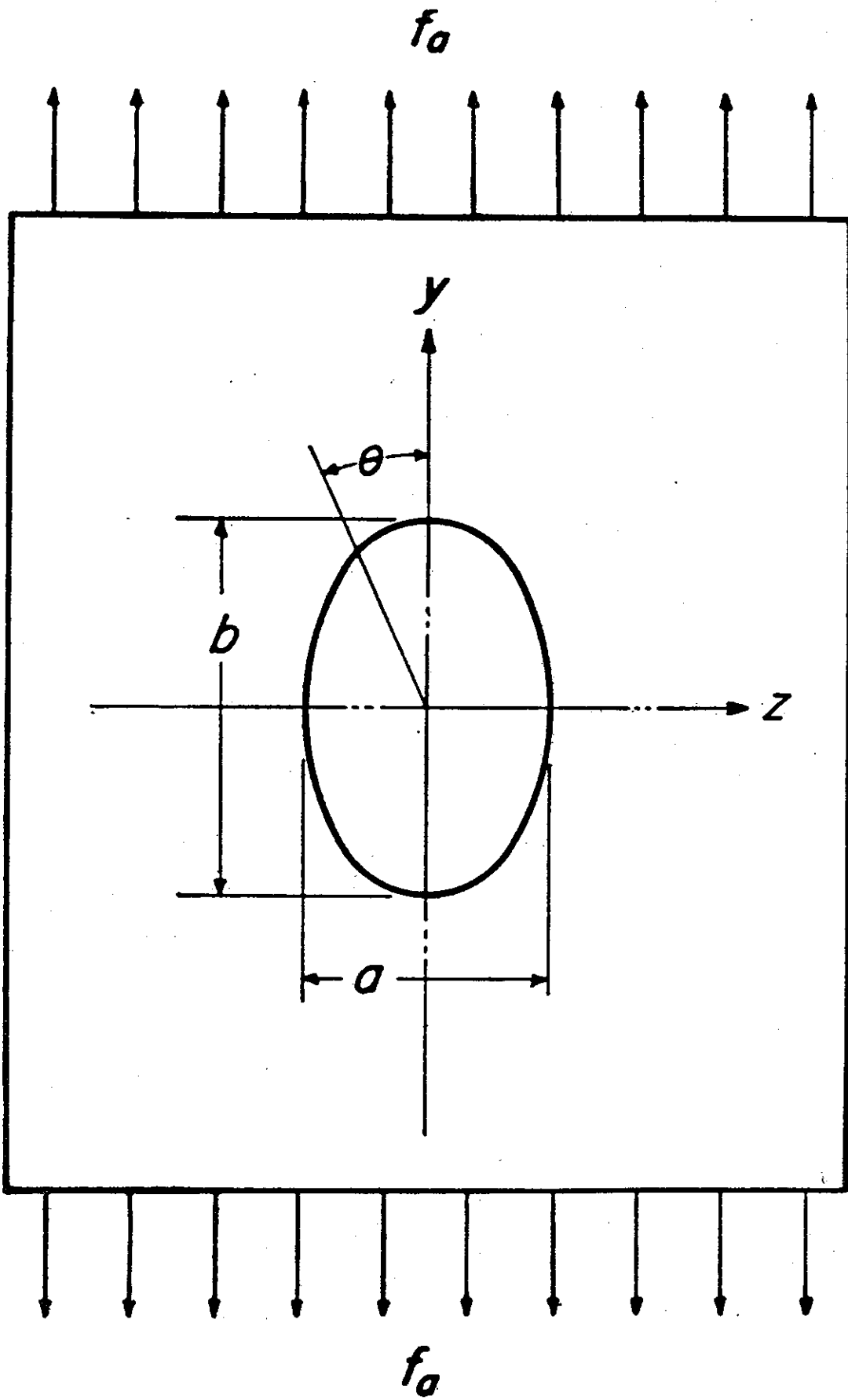

Figure 2-5. A wood or plywood panel pierced by an elliptical hole.

The shear stress on the periphery of the ellipse associated with relative shear displacements of axes y and z is given by equation (2:15):

$$f_s = f_a \frac{\frac{a}{b} \sqrt{\frac{E_y}{E_z}} \cos^2 \theta - \left[\sqrt{\frac{E_y}{G_{yz}} - 2\mu_{yz}} + 2 \sqrt{\frac{E_y}{E_z} + \frac{b}{a}} \right] \sin^2 \theta}{\left(\frac{a}{b}\right)^2 \frac{E_y}{E_z} \cos^4 \theta + \left[\frac{E_y}{G_{yz}} - 2\mu_{yz}\right] \sin^2 \theta + \cos^2 \theta \left(\frac{b}{a}\right)^2 \sin^4 \theta} \sin \theta \cos \theta \quad (2:15)$$

By use of equation (2:15) the shear stress can be plotted against θ and its maximum value found. For a plane sawed Sitka spruce panel pierced by a circular hole ($a=b$) a maximum value of $0.71 f_a$ was found at $\theta=78^\circ$ (see ref. 2-69).

Equations (2:14) and (2:15) can be used for plywood if the subscripts y and z are replaced by the subscripts b and a , respectively.

2.162. *Stress concentration due to a hole which is not small compared to the size of the member.* Stress concentrations in isotropic materials around holes that are not small compared to the size of the members pierced by them have been determined by photoelastic methods and are well known. It is impossible to use such methods in connection with wood, however, an estimate of the stress concentrations can be obtained by use of equation (2:14).

For an isotropic material equation (2:14) reduces to equation (2:16)

$$f = f_a \left(2 \frac{a}{b} + 1 \right) \quad (2:16)$$

An approximate corrective factor for use with the stress concentrations obtained for isotropic materials to obtain those for wood, or plywood, can be obtained by dividing values obtained by equation (2:14) by those obtained by equation (2:16). Of course such corrections do not apply to the shear stresses such as those obtained by equation (2:15).

2.2. Columns

2.20. PRIMARY FAILURE. The allowable stresses for solid wood columns are given by the following formulas:

Long columns

$$F_c = \frac{10 E_L}{\left(\frac{L'}{\rho}\right)^2} \text{ psi} \quad (2:17)$$

$$\left(\frac{L'}{\rho}\right)_{cr} = \sqrt{\frac{15 E_L}{F_{cu}}} \quad (2:17)$$

Short columns (ref. 2-97)

$$F_c = F_{cu} \left[1 - \frac{1}{3} \left(\frac{L'}{K\rho}\right)^4 \right] \text{ psi} \quad (2:18)$$

where

$$K = \left(\frac{L'}{\rho}\right)_{cr}$$

These formulas are reproduced graphically in figure 2-6 for solid wood struts of a number of species.

2.21. LOCAL BUCKLING AND TWISTING FAILURE. The formulas given in section 2.20 do not apply when columns with thin outstanding flanges or low torsional rigidity are subject to local buckling or twisting failure. For such cases, the allowable stresses are given by the following formulas:

Local buckling (torsionally rigid columns)

$$F_c = 0.07 E_L \left(\frac{t}{b}\right)^2 \text{ psi} \left(\text{when } \frac{b}{t} > 6\right) \quad (2:19)$$

Twisting failure (torsionally weak columns)

$$F_c = 0.044 E_L \left(\frac{t}{b}\right)^2 \text{ psi} \left(\text{when } \frac{b}{t} > 5\right) \quad (2:20)$$

When the width-thickness ratio (b/t) of the outstanding flange is less than the values noted, the column formulas of section 2.20 should be used. Failure due to local buckling or twisting can occur only when the critical stress for these types of failure is less than the stress required to cause primary failure. For unconventional shapes, tests should be conducted to determine suitable column curves (ref. 2-79).

2.22. LATERAL BUCKLING. When subjected to axial compressive loads, beams will act as columns tending to fail through lateral buckling. The usual column formulas (2:17 and 2:18) will apply except that when two beams are interconnected by ribs so that they will deflect together (laterally), the total end load carried by both beams will be the sum of the critical end loads for the individual beams.

The column lengths will usually be the length of a drag bay in a conventional wing. A restraint

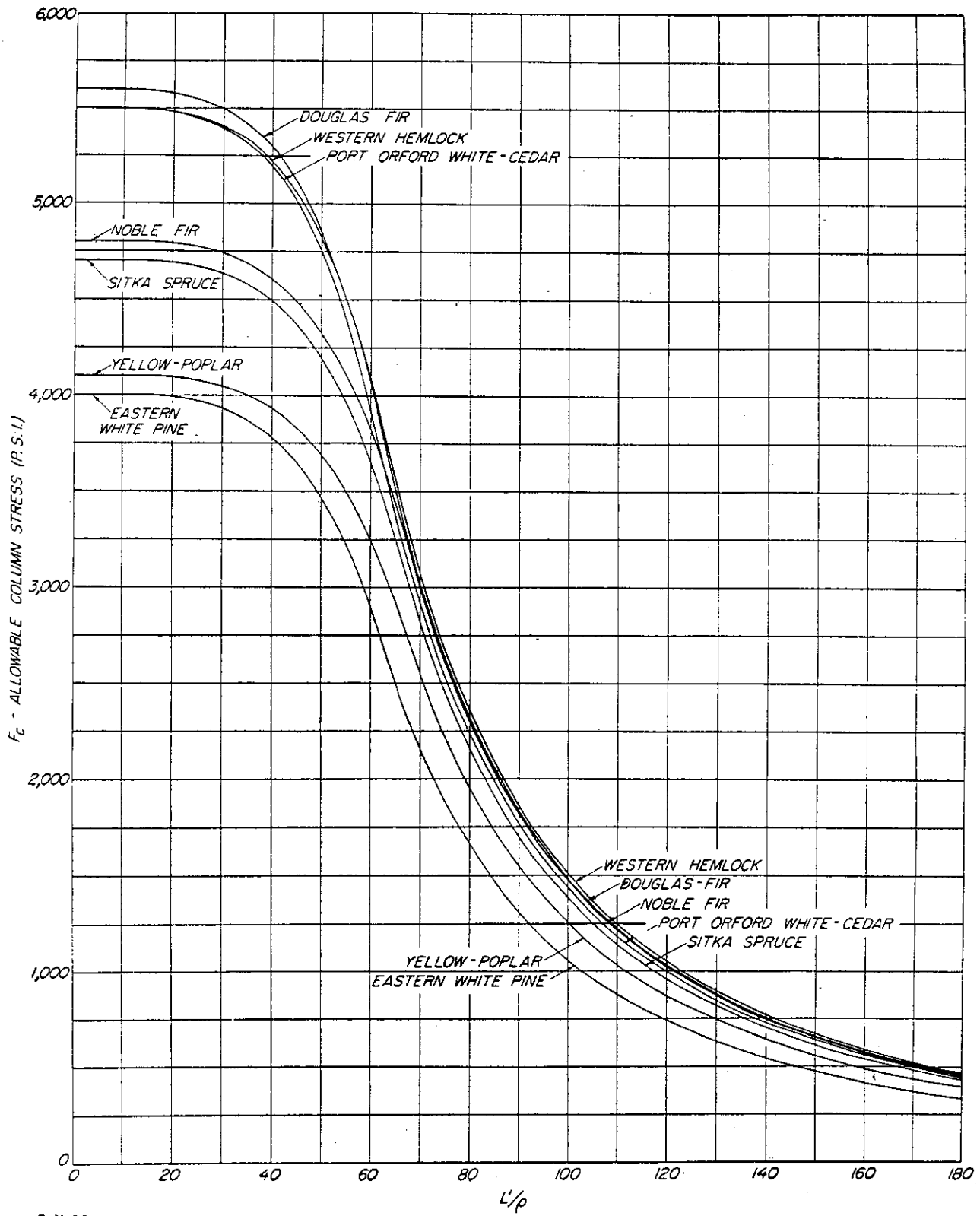

Z H 75270 F

Figure 2-6. Allowable column stresses for solid wood struts.

coefficient of 1.0 will be applicable unless the construction is such that additional restraint is afforded by the leading edge or similar parts. Certain rules for such conditions will be found in the requirements of the certificating or procuring agencies.

2.3. Beams

2.30. FORM FACTORS. When other than solid rectangular cross sections are used for beams (I-beams or box beams), the static-bending strength properties given in table 2-6 must be multiplied by a "form factor" for design purposes. This form factor is the ratio of either the fiber stress at proportional limit or the modulus of rupture (in bending) of the particular section to the same property of a standard 2-inch square specimen of that material. The proportional limit form factor (FF_p) is given by the formula:

$$FF_p = 0.58 + 0.42 \left(K \frac{b-b'}{b} + \frac{b'}{b} \right) \quad (2:21)$$

and the modulus of rupture form factor (FF_u) by the formula:

$$FF_u = 0.50 + 0.50 \left(K \frac{b-b'}{b} + \frac{b'}{b} \right) \quad (2:22)$$

where

b' = total web thickness

b = total flange width (including any web(s))

K = constant obtained from figure 2-7

Formulas 2:21 and 2:22 cannot be used to determine the form factors of sections in which the top and bottom edges of the beam are not perpendicular to the vertical axis of the beam. In such cases, it is first necessary to convert the section to an equivalent section whose height equals the mean height of the original section, and whose width and flange areas equal those of the original section, as shown in figure 2-7. The fact that the two beams of each pair shown in figure 2-7 developed practically the same maximum load in test demonstrates the validity of this conversion (ref. 2-56 and 2-62).

Tests have indicated that the modulus of rupture which can be developed by a beam of rectangular cross section decreases with the height. Sufficient data are not available to permit exact evaluation of the reduction as the height increases, but where deep beams of rectangular cross section are to be used, thought should be given to the

reduction of the value for modulus of rupture given in tables 2-6 and 2-7.

2.31. TORSIONAL INSTABILITY. It is possible for deep thin beams to fail through torsional instability at loads less than those indicated by the usual beam formula. Reference 2-63 gives formulas for calculating the strength of such beams for various conditions of end restraint. However, in view of the difficulty of accurately evaluating the modulus of rigidity and end fixity, it is always advisable to conduct static tests of a typical specimen. This will apply to cases in which the ratio of the moment of inertia about the horizontal axis to the moment of inertia about the vertical axis exceeds approximately 25 (ref. 2-62 and 2-63).

2.32. COMBINED LOADINGS.

2.320. *General.* Because of the variation of the strength properties of wood with the direction of loading with respect to the grain, no general rules for combined loadings can be presented, other than those for combined bending and compression given in section 2.321, and those for combined bending and tension given in section 2.322. When unusual loading combinations exist, static tests should be conducted to determine the desired information.

2.321. *Bending and compression.* When subjected to combined bending and compression, the allowable stress for spruce, Western hemlock, and noble fir beams at 15 percent moisture content can be determined from figure 2-8 and that for Douglas-fir beams from figure 2-9. The charts are based on a method of analysis developed by the Forest Products Laboratory (ref. 2-63 and 2-78).

The curves of figures 2-8 and 2-9 are based on the use of a fourth-power parabola for columns of intermediate length. On these figures the horizontal family of curves indicates the proportional limit under combined bending and compression; the vertical family, the effect of various slenderness ratios on bending. The allowable stress, F_{bc} , under combined load is found as follows:

- (1) For the cross section of a given beam, find the proportional limit in bending and the modulus of rupture from the ratios of compression-flange thickness to total depth and of web thickness to total width, locating such points as *A* and *B*.
- (2) Project points *A* and *B* to the central line, obtaining such points as *C* and *D*.

DEPTH OF COMPRESSION FLANGE
IN PERCENT OF TOTAL DEPTH

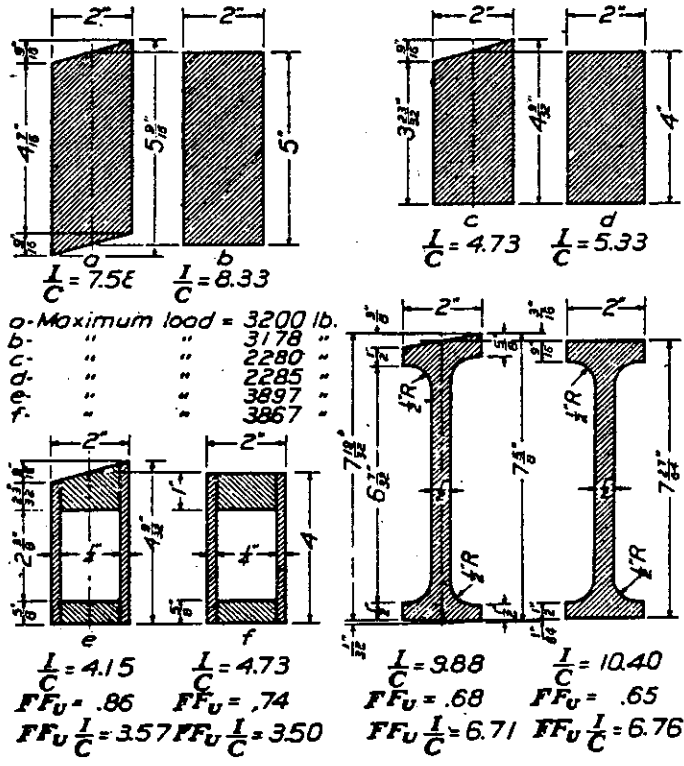
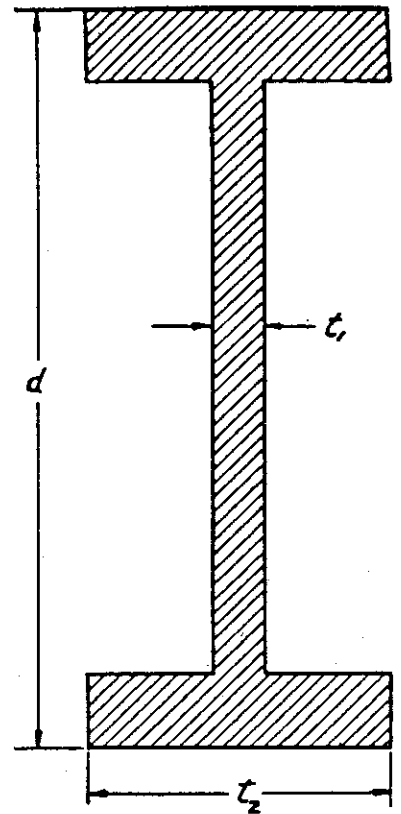
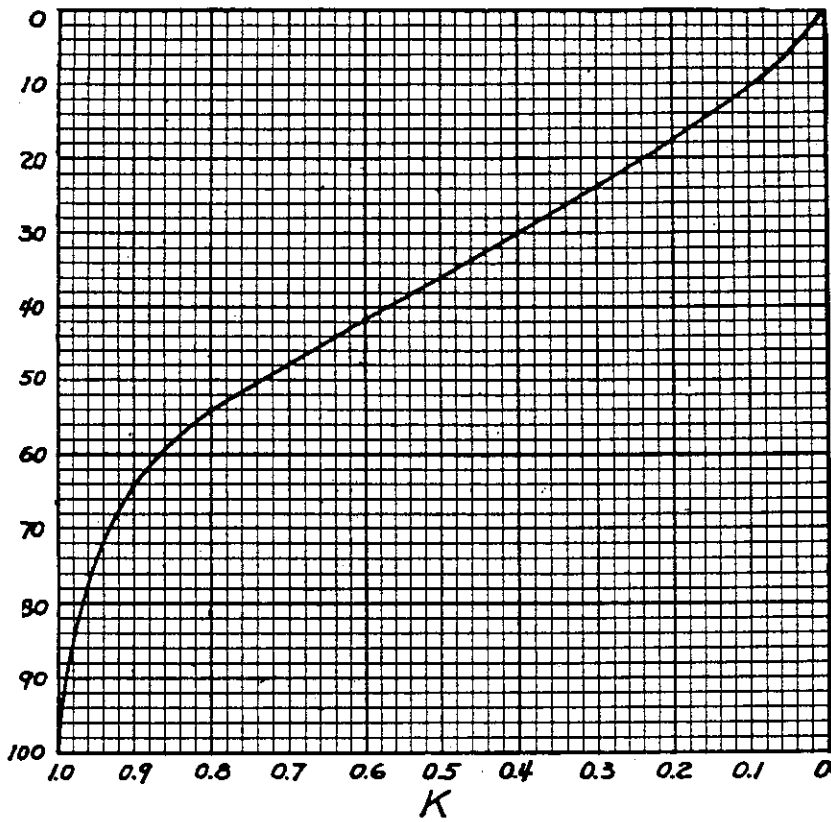

Figure 2-7. Form-factor curve and equivalent beam sections.

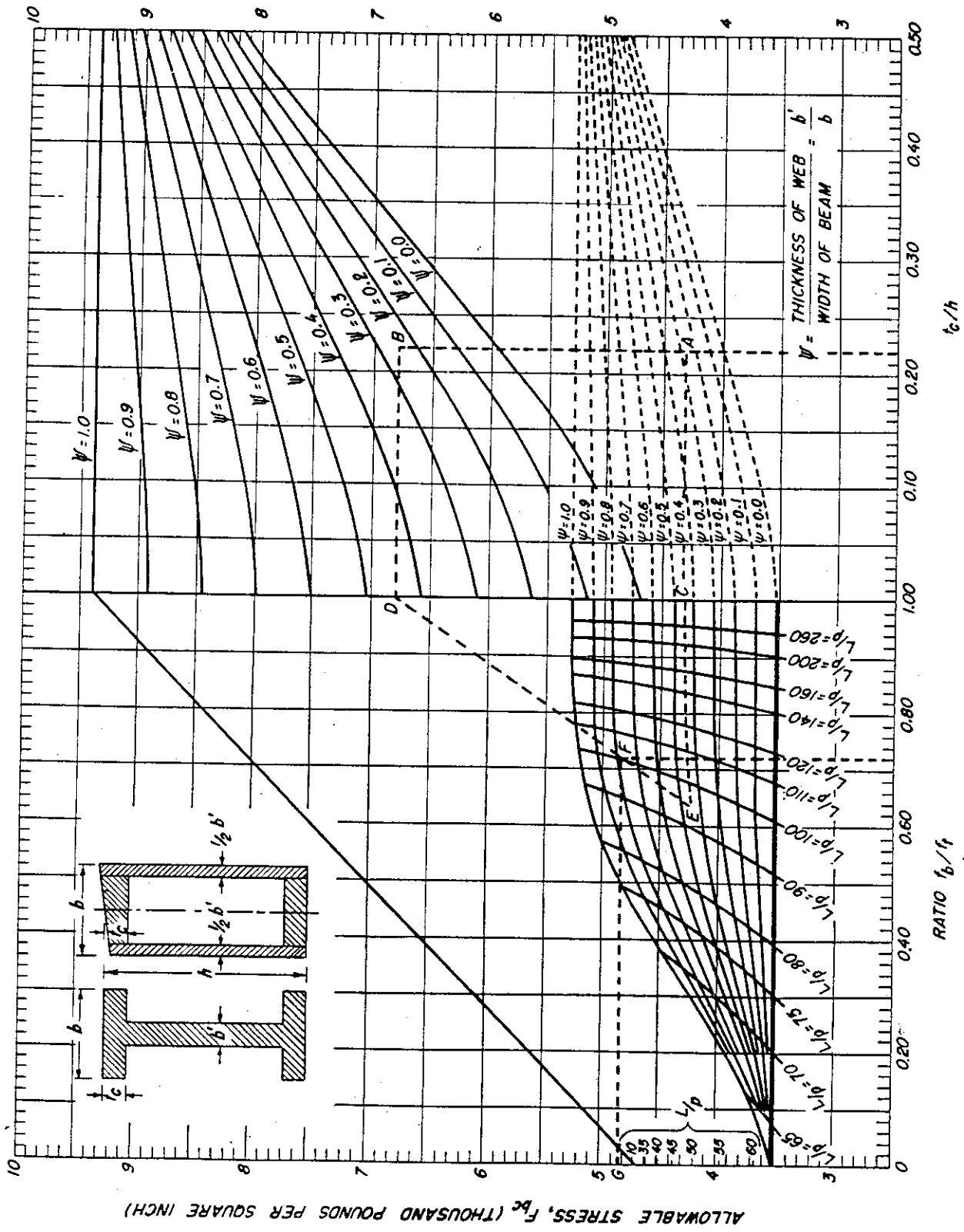

Figure 2-8. Allowable stresses for Sitka spruce spars subjected to combined bending and compression at 15 percent moisture content.

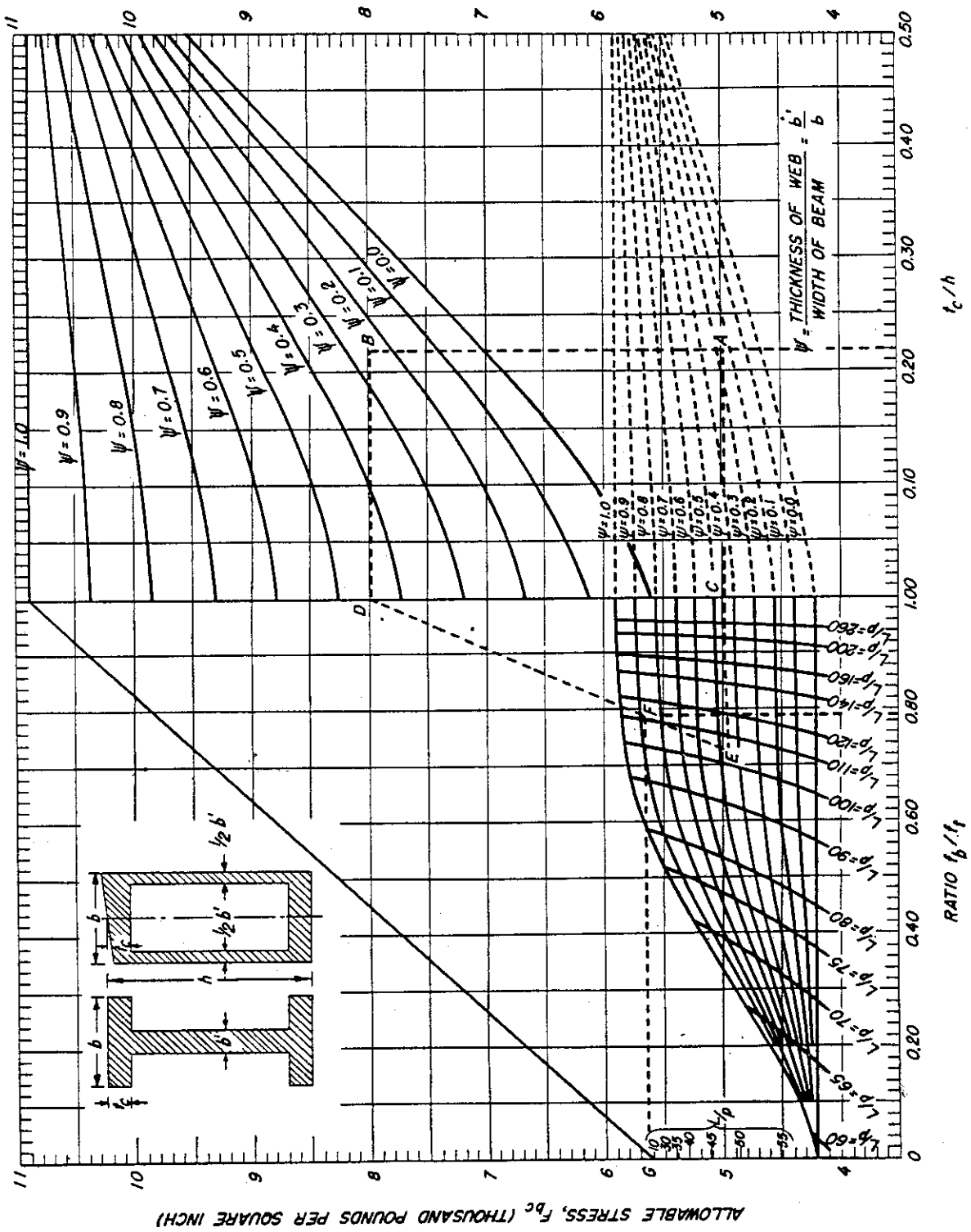

Figure 2-9. Allowable stresses for Douglas-fir spars subjected to combined bending and compression at 15 percent moisture content.

- (3) Locate a point, such as E , indicating the proportional limit of the given section under combined bending and compression. This point will be at the intersection of the curve of the "horizontal" family through C and the curve of the slenderness ratio corresponding to the distance between points of inflection.
- (4) Draw line ED .
- (5) Locate point F on line ED , with an abscissa equal to the computed ratio of bending to total stress. The ordinate of F represents the desired value of the allowable stress.

The following rules should be observed in the use of figures 2-8 and 2-9:

- (1) The length to be used in computing the slenderness ratio, L/ρ should be determined as follows:
 - (a) If there are no points of inflection between supports, L should be taken as the distance between supports.
 - (b) If there are two points of inflection between supports, L should be taken as the distance between these points of inflection when calculating the allowable strength of any section included therein.
 - (c) When calculating the allowable strength of a section between a point of inflection and an intermediate support of a continuous beam, L should be taken as the distance between the points of inflection adjacent to the support on either side.
 - (d) When investigating a section adjacent to an end support, L should be taken as twice the distance between the support and the adjacent point of inflection, except that it need not exceed the distance between supports.
- (2) In computing the value of ρ for use in determining the slenderness ratio, L/ρ , filler blocks should be neglected and, in the case of tapered spars, the average value should be used.
- (3) In computing the modulus of rupture and the proportional limit in bending, the properties of the section under investigation should be used. Filler blocks may be included in the section for this purpose. When computing the form factor of box

spars the total thicknesses of both webs should be used.

2.322. *Bending and tension.* When tensile axial loads exist, the maximum computed stress on the tension flange should not exceed the modulus of rupture of a solid beam in pure bending. Unless the tensile load is relatively large, the compression flange should also be checked, using the modulus of rupture corrected for form factor.

2.33. SHEAR WEBS. See section 2.73.

2.34. BEAM SECTION EFFICIENCY. In order to obtain the maximum bending efficiency of either I or box beams, the unequal flange dimensions can be determined by first designing a symmetrical beam of equal flanges. The amount of material to be transferred from the tension side to the compression side, keeping the total cross-sectional area, height, and width constant, is given by the following equation (ref. 2-62):

$$x = \frac{Abh^2 - \sqrt{A^2b^2h^4 - 4AI_s bhwD}}{2wDbh} \quad (2:23)$$

where

A = total area of the cross section

b = total width

h = total depth

w = width of flange

D = clear distance between flanges

I_s = moment of inertia of the symmetrical section

x = thickness to be taken from tension flange and added to compression flange

In using this equation, the following procedure is to be followed:

- (a) Determine the section modulus required.
- (b) Determine the sizes of flanges of equal size to give the required section modulus.
- (c) Using equation (2:23), compute the thickness of material to be transferred from the tension flange to the compression flange. The procedure thus far will result in a section modulus greater than required. To obtain a beam of the required section modulus, either (d) or (e) may be followed.
- (d) Calculate the ratio of depth of tension flange to compression flange and design a section having flanges with this ratio and the required section modulus, or
- (e) Carry out steps (a), (b), and (c) starting with a symmetrical section having a section modulus less than that required

until an unsymmetrical section having the required section modulus is obtained.

- (f) Beams designed according to the foregoing procedure should always be checked for adequacy of glue area between webs and tension flange. This consideration may govern the thickness of the tension flange.

2.4. Torsion

2.40. GENERAL. The torsional deformation of wood is related to the three moduli of rigidity, G_{LT} , G_{LR} , and G_{RT} . When a member is twisted about an axis parallel to the grain, G_{RT} is not involved; when twisted about an axis radial to the grain direction, G_{LT} is not involved; when twisted about an axis tangential to the grain direction, G_{LR} is not involved. No general relationship has

been found for the relative magnitudes of G_{LR} , G_{LT} , and G_{RT} (table 2-9).

2.41. TORSIONAL PROPERTIES. The "mean modulus of rigidity" (G) taken as 1/16 of E_L , may be safely used in the standard formulas for computing the torsional rigidities and internal shear stresses of solid wood members twisted about an axis parallel to the grain direction. Torsion formulas for a number of simple sections are given in table 2-10. For solid-wood members the allowable ultimate torsional shear stress (F_{st}) may be taken as the allowable shear stress parallel to the grain (column 14 in tables 2-6 and 2-7) multiplied by 1.18: that is, $F_{st} = 1.18 F_{su}$. The allowable torsional shear stress at the proportional limit may be taken as two-thirds of F_{st} . The torsional strength and rigidity of box beams having plywood webs are given in section 2.75.

Table 2-10. Formulas for torsion on symmetrical sections

Section	Angle of twist in radians	Maximum shear stress
Circle.....	$\theta = \frac{32TL}{G\pi D^4}$	$f_s = \frac{16T}{\pi D^3}$
Circular tube.....	$\theta = \frac{TL}{GI_p}$	$f_s = \frac{TD}{2I_p}$
Ellipse ¹	$\theta = \frac{TL(a+b)}{G\pi a^3 b^3}$	$f_s = \frac{2T}{\pi ab^2}$ at ends of short diameter
Square ²	$\theta = \frac{TL}{2.25Ga^4}$ (approx.)	$f_s = \frac{3T}{5a^3}$ (approx.)
Rectangle ³	$\theta = \frac{40I_p TL}{A^4 G}$ (approx.)	$f_s = \frac{T(15a+9b)}{40a^2 b^2}$ at midpoint of long side

¹2a=major axis; 2b=minor axis.

²2a=side of square.

³2a=long side, 2b=short side.

2.5. Basic Strength and Elastic Properties of Plywood

2.50. GENERAL. Plywood is usually made with an odd number of sheets or plies of veneer with the grain direction of adjacent plies at right angles. Depending upon the method by which the veneer is cut, it is known as rotary-cut, sliced, or sawed veneer. Generally, the construction is symmetrical; that is, plies of the same species, thickness, and grain direction are placed in pairs at equal distances from the central ply. Lack of symmetry results in twisting and warping of the finished panel. The disparity between the properties of wood in directions parallel to and across the grain is reduced by reason of the arrangement of the

material in plywood. By placing some of the material with its strong direction (parallel to grain) at right angles to the remainder, the strengths in the two directions become more or less equalized. Since shrinkage of wood in the longitudinal direction is practically negligible, the transverse shrinkage of each ply is restrained by the adjacent plies. Thus, the shrinking and swelling of plywood for a given change in moisture content is less than for solid wood.

The tendency of plywood to split is considerably less than for solid wood as a result of the cross-banded construction. While many woods are cut into veneer, those species which have been approved for use in aircraft plywood are listed in table 2-11.

2.51. ANALYSIS OF PLYWOOD STRENGTH PROPERTIES. The analysis of the strength and elastic properties of plywood is complicated by the fact that the elastic moduli of adjacent layers are different. This is illustrated in figure 2-10 for bending of a three-ply panel. Assuming that strain is proportional to distance from the neutral axis, stresses on contiguous sides of a glue joint will be different by reason of the difference in the modulus of elasticity in adjacent layers. This results in a distribution of stress across the cross section as shown in figure 2-10 (c). Similar irregular stress distribution will be obtained for plywood subjected to other types of loading.

From this it may be seen that the strength and elastic properties of plywood are dependent not only upon the strength of the material and the dimensions of the member, as for a solid piece, but also upon the number of plies, their relative thickness, and the species used in the individual plies. In addition, plywood may be used with the direction of the face plies at angles other than 0° or 90° to the direction of principal stress and, in special cases, the grain direction of adjacent plies may be oriented at angles other than 90°.

In general, plywood for aircraft use has the grain direction (the longitudinal direction) of adjacent plies at right angles. The strength and elastic properties of the plywood are dependent upon the properties of solid wood along and across the grain as illustrated in figure 2-11.

Considerable information (tables 2-6 and 2-7) on the properties of wood parallel to the grain is

available, but the data on properties across the grain are less complete. Sufficient data are available, however, so that the elastic properties of wood in the two directions can be related with reasonable accuracy to the plywood properties. On this basis formulas are given which will enable the designer, knowing the number, relative thickness and species of plies, to compute the properties of plywood from the data given in tables 2-6 and 2-7.

The formulas given are only for plywood having the grain direction of adjacent plies at right angles and are applicable only to certain directions of stress. The limitations on the angle between the face grain and the direction of principal stress have been noted in each section. The formulas are intended for use only in these cases, and the interpolation must not be used to obtain values for intermediate angles unless specific information on these angles is given. Computed values of certain of the strength and elastic properties for many of the commonly used species and constructions of plywood are given in section 2.54, based on strength of wood at 15 percent moisture content (table 2-6).

2.52. BASIC FORMULAS. For purposes of discussion, plywood structural shapes may be conveniently separated into two groups: (a) elements acting as prisms, columns, and beams, and (b) panels. The fundamental difference between these two groups is that, in group (a) the plywood is supported or restrained only on two opposite edges, while in group (b) the plywood is supported

Table 2-11. Veneer species for aircraft plywood

Group I (high density) ^{1 2}	Group II (medium density) ²	Group III (low density) ³
American beech.....	Birch (Alaska and paper).....	Basswood.
Birch (sweet and yellow).....	Khaya species (so-called "African mahogany").	Yellow-poplar.
Maple (hard).....	Southern magnolia.....	Port Orford White-cedar.
Pecan.....	Mahogany (from tropical America).	Spruce (red, Sitka, and white) (quarter-sliced).
	Maple (soft).....	Ponderosa pine (quarter-sliced).
	Sweetgum.....	Sugar pine.
	Water tupelo.....	Noble fir (quarter-sliced).
	Black walnut.....	Western hemlock (quarter-sliced).
	Douglas-fir (quarter-sliced).....	Redwood (quarter-sliced).
	American elm (quarter-sliced).....	
	Sycamore.....	

¹ Where hardness, resistance to abrasion, and high strength of fastening are desired, Group I woods should be used for face stock.

² Where finish is desired, or where the plywood is to be steamed and bent into a form in which it is to remain, species of Group I and II should be used.

³ Group III species are used principally for core stock and cross-banding. However, where high bending strength or freedom from buckling at minimum weight is desired, plywood made entirely from species of Group III is recommended.

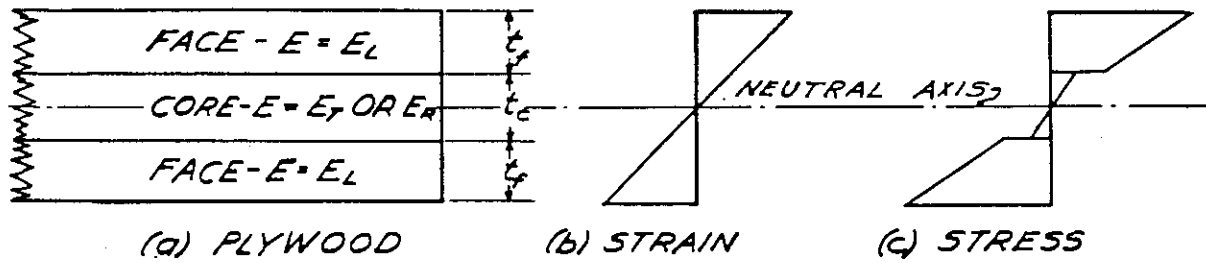

Figure 2-10. Three-ply plywood beam in bending.

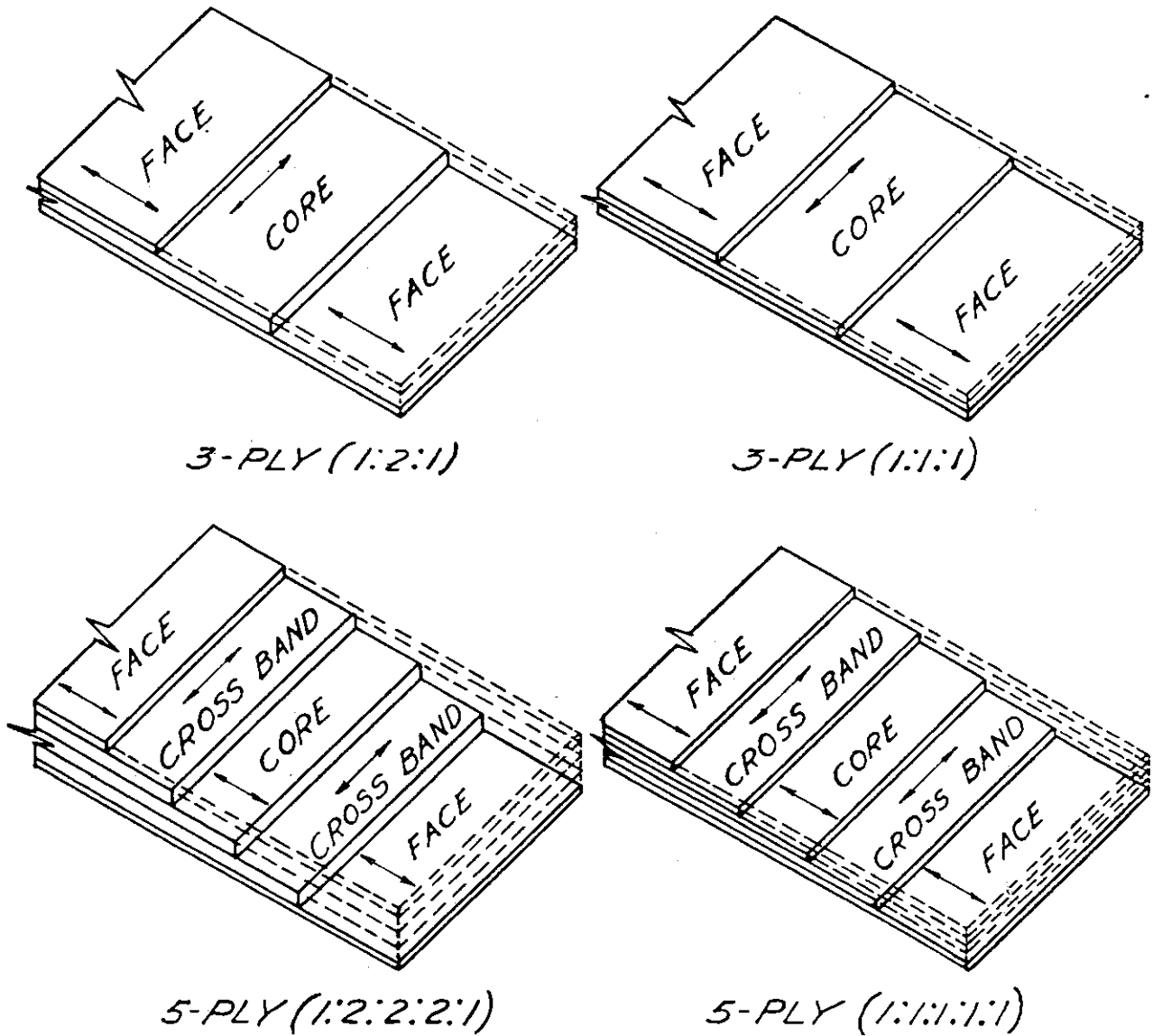

Figure 2-11. Typical plywood constructions. Arrows indicate grain direction of each ply.

or restrained on more than two edges. It is essential that this fundamental difference between the two groups be kept in mind during the application of the formulas¹ given here and in later sections (ref. 2-25, 2-43, and 2-54).

- (1) The effective moduli of elasticity of plywood in tension or compression are:

E_a —measured parallel to side a for panels (sec. 2.712, 2.713)

E_b —measured perpendicular to side a for panels (sec. 2.712, 2.713)

E_w —measured parallel to (with) the face grain

E_x —measured perpendicular to (across) the face grain, and are determined as

$$= \frac{1}{t} \sum_{i=1}^{i=n} E_i t_i \quad (2:24)$$

where

t = total thickness of plywood

t_i = thickness of i^{th} ply

E_i = modulus of elasticity of i^{th} ply measured in the same direction as the pertinent desired E (as E_a , E_b , E_w , or E_x). The value of E_i is equal to E_{Lc} (1.1 E_L from tables 2-6 and 2-7), or E_T , or E_R , (table 2-9) as applicable.

- (2) The effective moduli of elasticity of plywood in bending are:

E_1 —measured parallel to side a for panels

E_2 —measured perpendicular to side a for panels

E_{fw} —measured parallel to (with) the face grain

E_{fx} —measured perpendicular to (across) the face grain, and are determined as

$$f_s = \frac{1}{I} \sum_{i=1}^{i=n} E_i I_i \quad (2:25)$$

where

E_i —as defined under (1)

I = moment of inertia of the total cross section about the centerline, measured in the same direction as the pertinent desired E (namely, E_1 , E_2 , E_{fw} , or E_{fx}).

¹ When computing the various moduli of elasticity for plywood of balanced construction and all plies of the same species, the following relationship will be found helpful:

$$E_L + E_T = E_a + E_b = E_1 + E_2 = E_w + E_x = E_{fw} + E_{fx}$$

If the veneers are quarter-sliced rather than rotary-cut, the term E_T should be replaced by E_R .

I_i = moment of inertia of the i^{th} ply about the neutral axis of the same total cross section. For symmetrically constructed plywood, the neutral axis to be used in determining I_i will be the centerline of the cross section. For unsymmetrical plywood constructions, the neutral axis is usually not the centerline of the geometrical section. In this case the distance from this neutral axis to the extreme compression fiber is given by the equation:

$$c = \frac{\sum_{i=1}^{i=n} t_i E_i c_i}{\sum_{i=1}^{i=n} t_i E_i} \quad (2:26)$$

where

c_i = distance from the extreme compression fiber to the center of the i^{th} ply.

- (3) In calculating the bending strength (not stiffness) of plywood strips in bending having the face grain direction perpendicular to the span, a modulus E'_{fx} , similar to E_{fx} is to be used. For plywood made of five or more plies, the use of E'_{fx} for E_{fx} in strength calculations will result in but relatively small error. The value of E'_{fx} may be calculated in the same manner as that used in calculating E_{fx} except that the effect of the outer ply on the tension side is neglected. The location of the neutral axes used in calculating E_{fx} and E'_{fx} will be different. The value of E'_{fx} may also be calculated from the following formula:

$$E'_{fx} = E_{fx} + \frac{12 E_x}{t^2} \left(c' - \frac{t}{2} + t_f \right)^2 - \frac{12 t_f E_T}{t^3} \left(c' + \frac{t_f}{2} \right)^2 \quad (2:27)$$

where

$$c' = \frac{1}{2} \left[\frac{\frac{t E_x}{t_f E_T} (t - 2 t_f) + t_f}{\frac{t E_x}{t_f E_T} - 1} \right]$$

= distance from neutral axis to extreme fiber of the outermost longitudinal ply.

E_T pertains to the species of the face ply.

- (4) The modulus of rigidity (modulus of elasticity in shear) of solid wood involves the shear moduli G_{LT} , G_{LR} , and G_{RT} .

As mentioned in section 2.131, little information is available on this elastic property, and a "mean" modulus of rigidity is ordinarily used for wood. Similarly for plywood, a value of modulus of rigidity based on the "mean" modulus of rigidity for solid wood may be used.

For plywood (all plies the same species) having the facegrain parallel or perpendicular to the direction of principal shearing stress, the modulus of rigidity may be taken the same as for solid wood.

The theoretical treatment of the elastic properties of plywood involves the moduli of rigidity G_{wx} and G_{fwx} . They are determined as:

$$G_{wx} = \frac{1}{t} \sum_{i=1}^{i=n} G_i t_i \quad (2:28)$$

$$G_{fwx} = \frac{1}{I} \sum_{i=1}^{i=n} G_i I_i \quad (2:29)$$

where the summations are taken over all plies in a section perpendicular to either the a or b directions using the modulus of rigidity in each ply in the wx plane.

When the plywood is made of a single species of wood,

$$G_{fwx} = G_{wx} = G_{LT} \text{ for rotary-cut veneer.}$$

$$G_{fwx} = G_{wx} = G_{LR} \text{ for quarter-sliced veneer.}$$

(5) Poisson's ration (μ). Although there is very little information available on the values of Poisson's ratios for plywood, a brief summary of their significance is given.

The effective Poisson's ratio of plywood in tension or compression (no flexure) is the ratio of the contraction along the x direction to extension along the w direction due to tensile stress acting in the w direction and thus normal to the xt plane, or

$$\mu_{wx} = \frac{1}{t E_x} \sum_{i=1}^{i=n} t_i (E_x)_i (\mu_{wx})_i \quad (2:30)$$

where

$(E_x)_i$ = modulus of elasticity of the i^{th} ply in the x direction.

$(\mu_{wx})_i$ = Poisson's ratio of contraction along the x direction to extension in the w

direction due to a tensile stress acting the w direction and thus normal to the xt plane of the i^{th} ply.

Similarly

$$\mu_{xw} = \frac{1}{t E_w} \sum_{i=1}^{i=n} t_i (E_w)_i (\mu_{xw})_i \quad (2:31)$$

If all plies are of the same species of rotary-cut veneer

$$\mu_{wx} = E_L \mu_{TL} / E_x$$

$$\mu_{xw} = E_L \mu_{TL} / E_w$$

If all plies are of the same species of quarter-sliced veneer

$$\mu_{wx} = E_L \mu_{RL} / E_x$$

$$\mu_{xw} = E_L \mu_{RL} / E_w$$

These formulas give close approximations of the apparent Poisson's ratios in these two directions when the stress is simple tension or compression. For more accurate formulas than (2:30) and (2:31) see reference 2-65. For Poisson's ratio at an angle to the grain see section 2.56.

The Poisson's ratios associated with flexure are

$$\mu_{fwx} = \frac{1}{I E_{fx}} \sum_{i=1}^{i=n} I_i (E_x)_i (\mu_{fwx})_i \quad (2:32)$$

$$\mu_{fxw} = \frac{1}{I E_{fw}} \sum_{i=1}^{i=n} I_i (E_w)_i (\mu_{fxw})_i \quad (2:33)$$

These equations yield values identical to those of equations (2:30) and 2:31) if all plies of the plywood are of the same species of wood.

2.53. APPROXIMATE METHODS FOR CALCULATING PLYWOOD STRENGTHS. Table 2-12 gives some approximate methods of calculating the various strength properties of plywood. These simplified methods will be found very useful in obtaining estimates on the strength of plywood, but cannot be relied upon to give results that are comparable to those obtained with the more accurate methods previously given.

2.54 MOISTURE-STRENGTH RELATIONS FOR PLYWOOD.

2.540 *General*. The design values given in the plywood strength-property tables 2-13 and 2-14 were calculated from the strength properties of solid wood as given in table 2-6 based on a moisture content of 15 percent; and are applicable for design of aircraft to be used in the continental United States. For design of aircraft to be used

Table 2-12. Approximate methods for calculating the strength and stiffness of plywood¹

Property	Direction of stress with respect to direction of face grain	Portion of cross-sectional area to be considered	Allowables expressed in proportion of strength values given in table 2-6
Ultimate tensile	Parallel (F_{tww}) or perpendicular (F_{tuz}) $\pm 45^\circ$	Parallel plies ² only Full cross-sectional area	Modulus of rupture. One-fourth modulus of rupture.
Ultimate compressive	Parallel (F_{cww}) or perpendicular (F_{cuz}) $\pm 45^\circ$ (F_{cul6°)	Parallel plies ² only Full cross-sectional area	Maximum crushing strength or fiber stress at proportional limit, as required. One third maximum crushing strength or one-third fiber stress at proportional limit, as required.
Shear	Parallel or perpendicular (F_{swz}) $\pm 45^\circ$	Full cross-sectional area Full cross-sectional area	1.18 times the shearing-strength parallel to grain. 2.35 times the shearing strength parallel to grain
Shear in plane of plies	Parallel, perpendicular, or $\pm 45^\circ$	Joints between ribs, spars, etc., and continuous stressed plywood coverings; joints between webs (plywood) and flanges of I and box-beams; joints between ribs, spars, etc., and stressed plywood panels when plywood terminates at joint—use shear area over support.	One-third the shearing strength parallel to grain for the weakest species.
Load in bending	Parallel or perpendicular	Bending moment $M = KfI/c'$ where I = moment of inertia computed on basis of parallel plies only; c' = distance from neutral axis to outer fiber of outermost ply having its grain in direction of span; $K = 1.50$ for three-ply plywood having grain of outer plies perpendicular to span. $K = 0.85$ for all other plywood.	Modulus of rupture or fiber stress at proportional limit as required.
Deflection in bending	Parallel or perpendicular	Deflection may be calculated by the usual formulas, taking as the moment of inertia that of the parallel plies plus 1/20 that of the perpendicular plies. (When face plies are parallel, the calculation may be simplified, with but little error, by taking the moment of inertia as that of the parallel plies only).	Modulus of elasticity.
Deformation in tension or compression.	Parallel or perpendicular	Parallel plies ² only	Modulus of elasticity.
Bearing at right angles to plane of plywood.		Loaded area	Compression perpendicular to grain.

¹ These simplified strength calculations are to be used only as a rough guide in preliminary design work, and are not acceptable for final design when the results obtained differ considerably from those obtained by the more accurate methods given in this bulletin.

² By "parallel plies" is meant those plies whose grain direction is parallel to the direction of principal stress.

in tropical conditions, for which 20 percent moisture content is recommended, the design values for plywood may be calculated from basic strength properties of wood at 20 percent moisture content as given in table 2-7, or approximate adjustments may be made as indicated in the following sections.

Adjustment factors by which strength properties of solid wood may be corrected for moisture content are shown in table 2-2. For plywood, moisture corrections are dependent on many variable factors, such as grain direction, combinations of species, and relative thicknesses of plies in each direction, so that any rational method of correction is quite laborious. An approximate method for making moisture corrections to plywood is given in the succeeding sections.

2.541. *Approximate methods for making moisture corrections for plywood strength properties.* A limited number of compression, bending, and shear tests of spruce and Douglas-fir plywood of a few constructions at moisture content values ranging approximately from 6 to 15 percent has indicated that use of the following simplified methods of correcting plywood strength properties will be satisfactory (ref. 2-10 and 2-14).

2.5410. *Moisture corrections for plywood compressive strength (0° or 90° to face grain direction).* Moisture adjustments to the compressive strength of plywood, either parallel or perpendicular to the face grain direction, may be made by direct use of the correction constants given in column (6) of table 2-2.

When more than one species is used in the plywood, the correction constant should be taken for that species having its grain direction parallel to the applied load.

When plies of two species have their grain direction parallel to the applied load, the plywood correction constant should be determined by taking the mean value of the correction constants for the two species based on the relative areas of the longitudinal plies of each.

2.5411. *Moisture correction for plywood tensile strength (0° or 90° to face grain direction).* Data on the effect of moisture on the tensile strength of plywood are lacking. Limited data indicate that the effect on the tensile strength of wood is about one-third as great as on modulus of rupture. The suggested procedure for adjusting the tensile strength of plywood is to follow that for compressive strength as given in the preceding section, using one-third of the correction

factors given for modulus of rupture in column 3 of table 2-2.

2.5412. *Moisture corrections for plywood shear strength (0° or 90° to face grain direction).* Moisture adjustments to the shear strength of plywood, either parallel or perpendicular to the face grain direction, F_{swz} , may be made by direct use of empirical correction constants equal to those given in column (8) of table 2-2 for shear. The use of such moisture adjustment to the shear strength of plywood is not applicable when a moisture content of less than 7 percent is involved.

When more than one species is used, the correction constant should be determined on the basis of the relative areas of each species, considering all plies.

2.5413. *Moisture corrections for plywood compressive strength (any angle to face grain direction).* The compression strength of plywood at any moisture content, and at any angle to the face grain direction, may be found by use of equation 2:51 after first correcting the compression terms F_{cuw} and F_{cuz} in accordance with section 2.5410.

2.5414. *Moisture corrections for plywood tensile strength (any angle to face grain direction).* The tension strength of plywood at any moisture content, and at any angle to the face grain direction, may be found by use of equation 2:53 after first correcting the tension terms F_{tuw} and F_{tuz} in accordance with section 2.5411, and the shear term F_{swz} in accordance with section 2.5412.

2.5415. *Moisture corrections for plywood shear strength (any angle to face grain direction).* The shear strength of plywood at any moisture content, and at any angle to the face grain direction, may be found by use of equations 2:55 or 2:56 after first correcting the various terms in these equations by the methods outlined in the foregoing sections.

2.55. SPECIFIC GRAVITY-STRENGTH RELATIONS FOR PLYWOOD. As in solid wood, the strength and elastic properties of plywood increase with an increase in specific gravity. The magnitude of this strength increase, however, cannot be determined by the same convenient exponential equation given in table 2-1.

Specification AN-P-69a, *Plywood and Veneer, Aircraft Flat Panel*, controls the minimum specific gravity of the individual veneers used in the manufacture of the plywood, consequently assuring a minimum final specific gravity of the plywood. The "weight per square foot" column in table 2-13 for various plywood constructions has

Table 2-13. Strength and elastic properties of plywood at 15 percent moisture content
(Based on design data of table 2-6)

THREE-PLY

Nominal thickness	Species 1	Veneer thickness 2	Plywood weight (15 percent moisture) 3	Modulus of elasticity			Moment for fiber stress at proportional limit			Moment for modulus of rupture			Compression			Ultimate strength in tension			Ultimate strength in shear		
				Static bending			Compression			Ultimate strength in tension			Ultimate strength in shear								
				$E_{1/2}$	$E'_{1/2}$	Paral- lel 3	Per- pen- dicu- lar 3	In.-lb. per in. of width of width	In.-lb. per in. of width of width	Per- pen- dicu- lar 3	E_w	E_z	F_{rw}	F_{rz}	F_{cur}	F_{cur}	F_{taw}	F_{taw}	F_{twz}	F_{twz}	F_{ast}
(1)	(2)	(3)	(4)	(5)	(6)	(7)	(8)	(9)	(10)	(11)	(12)	(13)	(14)	(15)	(16)	(17)	(18)	(19)	(20)	(21)	(22)
.035	Birch-birch	In. F&B C .011	P. s. i. 0.146	1,000 1,785	149	110	1.27	0.23	2.53	0.562	1,000 1,357	P. s. i. 739	P. s. i. 3,130	P. s. i. 1,070	4,430	2,350	10,070	5,030	2,840	2,300	3,320
.070	Birch-birch	F&B C .020	.282	1,711	222	186	4.88	1.526	9.69	3.031	1,202	924	2,710	2,000	3,840	2,950	8,630	6,470	2,490	2,790	3,300
.070	Birch-yellow-poplar	F&B C .020	.242	1,709	175	137	4.87	.995	9.08	1.890	1,188	642	2,680	1,340	3,800	1,910	8,630	3,600	2,320	1,860	2,650
.070	Mahogany-mahogany	F&B C .020	.218	1,271	215	162	4.38	1.557	7.54	2.679	916	719	2,630	2,070	3,770	2,960	6,690	5,010	2,170	2,710	3,010
.070	Mahogany-yellow-poplar	F&B C .020	.205	1,265	205	152	4.36	1.078	7.51	2.015	886	662	2,650	1,390	3,650	1,980	6,690	3,690	2,140	1,900	2,500
.070	Yellow-poplar-yellow-poplar	F&B C .020	.198	1,134	170	140	2.90	1.015	5.42	1.897	770	665	1,610	1,390	2,300	1,980	4,650	3,950	2,090	1,820	1,990
.070	Sweetgum-sweetgum	F&B C .020	.223	1,240	167	137	3.98	1.267	7.19	2.299	874	674	2,000	1,550	2,850	2,190	6,400	4,800	2,230	2,070	2,450
.070	Sweetgum-yellow-poplar	F&B C .020	.208	1,230	160	130	3.98	.952	7.19	1.781	868	631	1,900	1,320	2,830	1,890	6,400	3,600	2,170	1,800	2,250
.070	Douglas-fir-Douglas-fir	F&B C .020	.223	1,371	200	163	3.80	1.282	7.01	2.369	978	761	2,530	1,970	3,360	2,620	6,230	4,670	2,110	2,420	2,730
.100	Birch-birch	F&B C .030	.302	1,737	196	159	10.11	2.838	20.08	5.638	1,258	869	2,840	1,960	4,020	2,780	9,060	6,040	2,020	2,660	3,350
.100	Birch-yellow-poplar	F&B C .030	.338	1,745	158	120	10.10	1.870	20.06	3.508	1,215	695	2,810	1,270	3,980	1,800	9,060	3,440	1,860	1,770	2,600
.100	Mahogany-mahogany	F&B C .030	.300	1,260	107	143	9.07	2.962	15.60	5.096	955	680	2,760	1,950	3,930	2,800	7,020	4,680	1,700	2,600	3,010
.100	Mahogany-yellow-poplar	F&B C .030	.283	1,266	189	135	9.04	2.058	15.56	3.847	928	627	2,670	1,310	3,820	1,870	7,020	3,440	1,670	1,810	2,560
.100	Yellow-poplar-yellow-poplar	F&B C .030	.275	1,149	155	131	5.99	1.938	11.20	3.622	797	637	1,670	1,330	2,380	1,900	4,820	3,780	1,620	1,770	2,010
.100	Sweetgum-sweetgum	F&B C .030	.303	1,259	148	118	8.25	2.366	14.90	4.274	914	634	2,100	1,450	2,930	2,060	6,720	4,480	1,760	1,970	2,480
.100	Sweetgum-yellow-poplar	F&B C .030	.288	1,258	143	112	8.24	1.782	14.89	3.332	908	594	2,030	1,240	2,960	1,770	6,720	3,440	1,700	1,710	2,240
.100	Douglas-fir-Douglas-fir	F&B C .030	.308	1,362	189	143	7.86	2.419	14.52	4.470	1,021	718	2,650	1,860	3,510	2,470	6,540	4,300	1,630	2,310	2,730

.125	Birch-birch.....	F&B C	.034 .060	.494	1,068	265	229	15.17	5.544	30.14	11.015	1,124	1,063	2,540	2,260	3,590	3,200	8,020	7,050	1,800	2,970	3,200
.125	Birch-yellow-poplar.....	F&D C	.034 .060	.414	1,065	293	166	15.14	3.560	30.08	6.655	1,100	693	2,500	1,450	3,540	2,070	8,020	4,030	1,610	2,000	2,600
.125	Mahogany-mahogany.....	F&B C	.034 .060	.377	1,241	246	193	13.63	5.508	23.40	9.478	861	774	2,470	2,230	3,540	3,190	6,220	5,440	1,440	2,840	2,970
.125	Mahogany-yellow-poplar.....	F&D C	.034 .060	.352	1,234	213	181	13.56	3.798	23.34	7.100	828	713	2,340	1,490	3,410	2,120	6,220	4,030	1,440	2,010	2,600
.125	Yellow-poplar-yellow-poplar.....	F&B C	.034 .060	.342	1,100	203	180	8.96	3.093	16.76	6.904	717	717	1,500	1,500	2,140	2,140	4,300	4,300	1,400	1,920	1,920
.125	Sweetgum-sweetgum.....	F&B C	.034 .060	.388	1,209	198	169	12.38	4.588	22.37	8.287	818	730	1,870	1,670	2,600	2,350	5,950	5,250	1,540	2,210	2,370
.125	Sweetgum-yellow-poplar.....	F&B C	.034 .060	.358	1,208	189	159	12.37	3.438	22.34	6.428	811	684	1,860	1,430	2,640	2,040	5,950	4,630	1,470	1,930	2,210
.125	Douglas-fir-Douglas-fir.....	F&B C	.034 .060	.388	1,338	243	198	11.81	4.582	21.81	8.406	917	822	2,380	2,130	3,150	2,830	5,790	5,110	1,410	2,540	2,680
.155	Birch-birch.....	F&B C	.040 .080	.612	1,629	304	268	22.78	9.426	45.26	18.726	1,063	1,063	2,400	2,400	3,400	3,400	7,550	7,550	1,430	3,100	3,100
.155	Birch-yellow-poplar.....	F&B C	.040 .080	.505	1,625	220	193	22.73	5.092	45.16	11.203	1,047	733	2,360	1,510	3,340	2,190	7,550	4,300	1,430	2,100	2,640
.155	Mahogany-mahogany.....	F&B C	.040 .080	.465	1,213	273	222	20.50	9.206	35.27	15.839	818	818	2,350	2,350	3,360	3,360	5,850	5,850	1,310	2,910	2,910
.155	Mahogany-yellow-poplar.....	F&B C	.040 .080	.432	1,205	258	207	20.36	6.329	35.04	11.833	783	752	2,250	1,570	3,220	2,240	5,850	4,300	1,270	2,600	2,580
.155	Yellow-poplar-yellow-poplar.....	F&B C	.040 .080	.398	1,100	203	180	13.78	5.678	25.77	10.616	717	717	1,500	1,500	2,140	2,140	4,300	4,300	1,230	1,920	1,920
.155	Sweetgum-sweetgum.....	F&B C	.040 .080	.478	1,181	226	197	18.60	7.781	33.59	14.056	774	774	1,770	1,770	2,520	2,520	5,600	5,600	1,370	2,300	2,300
.155	Sweetgum-yellow-poplar.....	F&B C	.040 .080	.438	1,179	215	186	18.57	5.821	33.55	10.883	767	724	1,760	1,520	2,500	2,160	5,600	4,300	1,360	2,620	2,160
.155	Douglas-fir-Douglas-fir.....	F&B C	.040 .080	.478	1,308	273	220	17.74	7.769	32.78	14.242	849	869	2,250	2,250	2,600	2,900	5,450	5,450	1,240	2,620	2,620
.185	Birch-birch.....	F&B C	.047 .095	.718	1,626	308	272	32.38	13.542	64.33	26.906	1,058	1,068	2,390	2,410	3,380	3,410	7,510	7,510	1,510	3,100	3,090
.185	Birch-yellow-poplar.....	F&B C	.047 .095	.501	1,622	231	195	32.31	8.602	64.19	16.082	1,042	737	2,350	1,540	3,330	2,200	7,510	4,320	1,310	2,110	2,640
.185	Mahogany-mahogany.....	F&B C	.047 .095	.545	1,211	276	225	20.14	13.206	50.14	22.725	814	821	2,340	2,360	3,350	3,380	5,820	5,880	1,190	2,920	2,910
.185	Mahogany-yellow-poplar.....	F&D C	.047 .095	.505	1,203	260	209	28.95	9.078	40.81	16.073	779	755	2,240	1,580	3,210	2,250	5,820	4,320	1,150	2,100	2,580
.185	Yellow-poplar-yellow-poplar.....	F&B C	.047 .095	.466	1,098	206	183	19.59	8.158	36.63	15.252	714	721	1,490	1,510	2,130	2,150	4,280	4,320	1,120	1,920	1,910
.185	Sweetgum-sweetgum.....	F&B C	.047 .095	.560	1,178	229	200	26.43	11.176	47.75	20.180	770	778	1,770	1,780	2,510	2,530	5,570	5,630	1,250	2,300	2,290
.185	Sweetgum-yellow-poplar.....	F&B C	.047 .095	.513	1,177	217	188	26.40	8.360	47.08	15.630	763	728	1,750	1,520	2,480	2,170	5,570	4,320	1,180	2,020	2,150
.185	Douglas-fir-Douglas-fir.....	F&B C	.047 .095	.560	1,305	270	232	25.22	11.060	46.59	20.444	805	873	2,240	2,240	2,980	3,000	5,420	5,480	1,130	2,620	2,620

See footnotes at end of table.

Table 2-19. Strength and elastic properties of plywood at 15 percent moisture content—Continued

FIVE-PLY

Nominal thickness	Species ¹	Veneer thickness ²	Plywood weight (15 percent moisture) ³	Static bending						Compression				Ultimate strength in shear								
				Modulus of elasticity		Moment for fiber stress at proportional limit		Moment for modulus of rupture		Modulus of elasticity ⁴		Fiber stress at proportional limit		Maximum crushing strength		Ultimate strength in tension						
				$E_{1/2}$	$E_{1/3}$	Parallel ³	Perpendicular ³	Parallel ³	Perpendicular ³	Parallel ³	Perpendicular ³	E_x	E_y	F_{cpw}	F_{cpz}	F_{100}	F_{102}	F_{103}	F_{104}	F_{105}		
(1)	(2)	(3)	(4)	(5)	(6)	(7)	(8)	(9)	(10)	(11)	(12)	(13)	(14)	(15)	(16)	(17)	(18)	(19)	(20)	(21)	(22)	
.160	Birch-birch	F&B .030 XB .034 C .030	P. s. i. 0.629 P. s. i. 0.499	1,000 1,441	403 353	1,000 401	21.46 21.30	11.47 7.09	42.64 42.32	22.78 13.26	1,000 1,109	1,000 924	2,700 2,000	2,220 1,340	3,830 2,900	3,100 1,900	8,000 7,370	6,500 3,700	2,200 2,050	2,200 1,840	2,800 2,400	3,300 2,400
.160	Birch-yellow-poplar	F&B .030 XB .034 C .030	P. s. i. 0.454	1,070	407	362	19.43	10.60	33.43	18.38	914	722	2,020	2,070	3,760	2,970	6,660	5,040	1,070	2,710	3,010	3,010
.160	Mahogany-mahogany	F&B .030 XB .034 C .030	P. s. i. 0.444	1,064	379	334	19.15	7.27	32.96	13.59	859	652	1,800	1,360	2,560	1,940	6,090	3,700	1,930	1,850	2,110	2,110
.160	Mahogany-yellow-poplar	F&B .030 XB .034 C .030	P. s. i. 0.419	973	331	311	12.98	6.93	24.27	12.95	809	625	1,690	1,310	2,410	1,860	4,000	3,700	1,900	1,740	2,020	2,020
.160	Yellow-poplar-yellow-poplar	F&B .030 XB .034 C .030	P. s. i. 0.408	1,045	362	337	17.53	9.40	31.68	16.99	871	676	2,000	1,560	2,840	2,200	6,380	4,820	2,030	2,080	2,450	2,450
.160	Sweetgum-sweetgum	F&B .030 XB .034 C .030	P. s. i. 0.449	1,041	341	316	17.47	7.00	31.56	13.09	846	631	1,770	1,320	2,520	1,880	5,800	3,700	1,950	1,700	2,080	2,080
.160	Sweetgum-yellow-poplar	F&B .030 XB .034 C .030	P. s. i. 0.498	1,100	420	382	16.78	9.12	30.99	11.81	975	764	2,530	1,980	3,350	2,630	6,210	4,630	1,910	2,420	2,730	2,730
.180	Douglas-fir-Douglas-fir	F&B .034 XB .047 C .030	P. s. i. 0.754	1,381	552	522	29.01	17.66	57.64	35.09	1,084	1,043	2,440	2,350	3,400	3,330	7,710	7,390	2,070	3,050	3,130	3,130
.180	Birch-yellow-poplar	F&B .034 XB .047 C .030	P. s. i. 0.598	1,356	492	372	28.40	11.05	56.60	20.66	973	701	2,010	1,470	2,900	2,090	6,730	4,120	1,820	2,000	2,370	2,370
.180	Mahogany-mahogany	F&B .034 XB .047 C .030	P. s. i. 0.578	1,037	449	406	26.33	16.36	45.30	28.15	832	803	2,300	2,310	3,420	3,300	5,970	5,730	1,750	2,400	2,940	2,940
.180	Mahogany-yellow-poplar	F&B .034 XB .047 C .030	P. s. i. 0.536	1,010	426	383	25.63	11.28	44.10	21.09	790	714	1,650	1,500	2,350	2,130	5,550	4,120	1,710	1,990	2,040	2,040

.100	Yellow-poplar-yellow-poplar	F&B XD C	.034 .047 .034	.507	923	381	361	17.37	10.84	32.48	20.26	744	680	1,560	1,450	2,220	2,060	4,480	4,120	1,680	1,870	1,950
.100	Sweetgum-sweetgum	F&B XB C	.034 .047 .040	.594	1,002	405	381	23.71	14.47	42.83	20.14	788	759	1,810	1,740	2,570	2,470	5,720	5,480	1,820	2,270	2,330
.100	Sweetgum-yellow-poplar	F&B XB C	.034 .047 .030	.541	988	390	366	23.38	10.93	42.23	20.44	778	695	1,630	1,460	2,320	2,070	5,380	4,120	1,730	1,930	2,020
.100	Douglas-fir-Douglas-fir	F&B XB C	.034 .031 .047 .030	.594	1,114	467	430	22.71	13.90	41.95	25.85	885	854	2,200	2,210	3,040	2,940	5,500	5,340	1,690	2,600	2,640
.225	Birch-birch	F&B XB C	.040 .030 .030	.893	1,364	569	539	40.18	25.37	79.84	50.41	1,021	1,106	2,300	2,490	3,260	3,530	7,220	7,880	1,890	3,170	3,010
.225	Birch-yellow-poplar	F&B XB C	.040 .030 .030	.693	1,354	404	374	39.90	15.64	79.28	29.24	918	757	1,920	1,590	2,740	2,260	6,370	4,490	1,640	2,130	2,340
.225	Mahogany-mahogany	F&B XB C	.040 .030 .030	.682	1,025	461	419	36.49	23.48	62.78	40.40	788	848	2,200	2,440	3,210	3,490	5,600	6,100	1,570	2,960	2,860
.225	Mahogany-yellow-poplar	F&B XB C	.040 .030 .030	.620	1,008	428	386	35.87	15.08	61.71	29.87	734	770	1,540	1,610	2,100	2,200	5,100	4,490	1,530	2,100	1,070
.225	Yellow-poplar-yellow-poplar	F&B XB C	.040 .030 .034	.596	913	391	372	24.09	15.54	45.03	29.06	709	734	1,470	1,540	2,000	2,100	4,100	4,410	1,500	1,640	1,800
.225	Sweetgum-sweetgum	F&B XB C	.010 .030 .030	.702	990	417	393	32.84	20.79	59.33	37.56	743	804	1,700	1,840	2,420	2,020	5,300	5,840	1,640	2,350	2,240
.225	Sweetgum-yellow-poplar	F&B XB C	.010 .030 .030	.627	986	392	308	32.71	15.47	59.10	28.92	723	751	1,510	1,570	2,160	2,240	5,020	4,490	1,550	2,050	1,950
.225	Douglas-fir-Douglas-fir	F&B XB C	.010 .030 .030	.702	1,100	480	444	31.46	20.09	58.13	37.12	836	902	2,170	2,340	2,880	3,100	5,210	5,600	1,510	2,600	2,570
.250	Birch-birch	F&B XB C	.047 .050 .010	.981	1,415	518	487	51.48	29.18	102.28	57.97	1,117	1,010	2,520	2,280	3,570	3,230	7,970	7,130	1,800	2,990	3,190
.250	Birch-yellow-poplar	F&B XB C	.047 .050 .010	.784	1,384	382	351	50.43	18.30	100.20	34.38	1,008	676	2,110	1,420	3,000	2,020	6,990	3,950	1,540	1,910	2,390
.250	Mahogany-mahogany	F&B XB C	.047 .050 .010	.748	1,062	426	381	46.65	27.13	80.27	46.07	856	780	2,460	2,240	3,520	3,210	6,170	5,540	1,450	2,850	2,970
.250	Mahogany-yellow-poplar	F&B XB C	.047 .050 .017	.698	1,032	406	363	45.36	18.80	78.05	35.16	818	680	1,710	1,440	2,440	2,050	5,750	3,650	1,440	1,940	2,080
.250	Yellow-poplar-yellow-poplar	F&B XB C	.047 .050 .047	.659	914	360	340	39.75	18.01	57.48	33.67	770	664	1,610	1,300	2,300	1,980	4,650	3,050	1,400	1,820	1,990
.250	Sweetgum-sweetgum	F&B XB C	.047 .040 .040	.770	1,027	380	355	42.06	23.92	75.09	43.21	812	735	1,960	1,690	2,650	2,300	5,910	5,290	1,510	2,220	2,370

See footnotes at end of table.

Table 2-13. Strength and elastic properties of plywood at 15 percent moisture content—Continued

FIVE PLY—Continued

Nominal thickness	Species 1	Veneer thickness 2	Plywood weight (15 percent moisture) 2	Static bending						Compression				Ultimate strength in tension			Ultimate strength in shear				
				Modulus of elasticity		Moment for fiber stress at proportional limit		Moment for modulus of rupture		Modulus of elasticity 4		Fiber stress at proportional limit		Maximum crushing strength		F _{tu}		F _{us}		F _{ds}	
				E _{1s}	E _{1s}	Parallel 3	Perpendicular 3	In.-lb. per in. of width	In.-lb. per in. of width	In.-lb. per in. of width	In.-lb. per in. of width	E _s	E _s	F _{cpw}	F _{cpw}	F _{cuw}	F _{cuw}	F _{tu}	F _{tu}	F _{us}	F _{us}
(1)	(2)	(3)	(4)	(5)	(6)	(7)	(8)	(9)	(10)	(11)	(12)	(13)	(14)	(15)	(16)	(17)	(18)	(19)	(20)	(21)	(22)
.250	Sweetgum-yellow-poplar	F&B XB C	In. 0.047 .060	1,000 P. s. i. 1,010	370	345	41.38	18.18	74.75	33.89	1,000 P. s. i. 806	828	1,600	1,400	2,400	2,000	5,580	3,950	1,450	1,880	2,050
.250	Douglas-fir-Douglas-fir	F&B XB C	.047 .060 .040	1,141	440	402	40.26	23.16	74.38	42.80	911	828	2,360	2,150	3,130	2,850	5,750	5,150	1,410	2,550	2,670
.315	Birch-birch	F&B XB C	.060 .080 .040	1,422	511	480	82.12	46.04	163.17	91.48	1,053	1,053	2,400	2,400	3,400	3,400	7,550	7,550	1,620	3,100	3,100
.315	Birch-yellow-poplar	F&B XB C	.060 .080 .047	1,398	376	344	80.72	28.99	160.39	54.19	973	715	2,040	1,500	2,900	2,130	6,780	4,210	1,370	2,680	2,300
.315	Mahogany-mahogany	F&B XB C	.060 .080 .047	1,066	420	376	74.40	42.87	128.02	73.76	818	818	2,350	2,350	3,360	3,360	5,850	5,850	1,200	2,910	2,910
.315	Mahogany-yellow-poplar	F&B XB C	.060 .080 .047	1,040	400	356	72.54	29.68	124.81	55.49	728	728	1,630	1,510	2,320	2,170	5,530	4,210	1,250	2,020	2,030
.315	Yellow-poplar-yellow-poplar	F&B XB C	.060 .080 .047	950	354	334	49.15	23.35	91.89	53.00	731	703	1,530	1,470	2,180	2,100	4,390	4,210	1,220	1,890	1,940
.315	Sweetgum-sweetgum	F&B XB C	.060 .080 .047	1,032	375	350	67.10	37.76	121.21	68.20	774	774	1,770	1,770	2,520	2,520	5,600	5,600	1,300	2,300	2,300
.315	Sweetgum-yellow-poplar	F&B XB C	.060 .080 .047	1,017	364	339	66.16	23.64	119.52	51.54	767	708	1,610	1,450	2,200	2,110	5,350	4,210	1,270	1,960	2,010
.315	Douglas-fir-Douglas-fir	F&B XB C	.060 .080 .047	1,146	435	397	64.22	36.59	118.64	67.59	869	869	2,250	2,250	2,900	2,890	5,450	5,450	1,230	2,620	2,620
.375	Birch-birch	F&B XB C	.080 .095 .080	1,279	654	626	104.68	77.22	207.97	153.43	1,058	1,058	2,450	2,340	3,480	3,320	7,710	7,360	1,500	3,050	3,150
.375	Birch-yellow-poplar	F&B XB C	.080 .095 .080	1,264	460	432	103.47	47.38	205.58	88.58	937	710	1,900	1,490	2,790	2,120	6,410	4,190	1,230	2,610	2,320

.375	Mahogany-mahogany	F&B XB	.060 .095	1.122	985	522	482	95.41	70.94	104.16	122.06	835	800	2,400	2,300	3,440	3,290	6,000	5,700	1,180	2,880	2,950
.375	Mahogany-yellow-poplar	F&B C	.060 .080	1.010	944	482	443	93.30	48.15	100.54	90.02	775	721	1,620	1,510	2,310	2,150	5,360	4,190	1,130	2,000	2,020
.375	Yellow-poplar-yellow-poplar	F&B XB	.060 .095	.900	863	440	422	63.30	46.68	118.34	87.27	734	700	1,540	1,470	2,100	2,000	4,410	4,190	1,110	1,890	1,940
.375	Sweetgum-sweetgum	F&B C	.060 .080	1.155	929	478	456	85.59	63.21	154.62	114.19	792	756	1,820	1,730	2,580	2,460	5,740	5,460	1,240	2,260	2,330
.375	Sweetgum-yellow-poplar	F&B XB	.060 .095	1.020	924	449	427	85.13	47.00	153.78	87.86	764	705	1,600	1,480	2,280	2,100	5,210	4,190	1,150	1,950	2,000
.375	Douglas-fir-Douglas-fir	F&B XB C	.060 .095 .080	1.155	1,034	546	513	82.14	60.88	151.74	112.47	889	850	2,300	2,200	3,060	2,920	5,590	5,310	1,120	2,590	2,650

SEVEN-PLY (All plies of equal thickness)

0.410	Birch-birch	.060	1.02	1,340	593	567	131.1	80.91	280.5	160.75	1,202	924	2,710	2,090	3,840	2,950	8,630	6,470	1,720	2,700	3,300
.410	Birch-yellow-poplar	.060	1.22	1,286	418	391	125.8	40.60	250.0	92.84	1,000	632	2,090	1,320	2,980	1,800	6,770	3,690	1,440	1,820	2,320
.410	Mahogany-mahogany	.060	1.23	1,008	478	441	119.2	75.00	205.0	120.20	916	719	2,630	2,070	3,770	2,960	6,600	5,010	1,400	2,710	3,010
.410	Mahogany-yellow-poplar	.060	1.10	981	439	401	116.0	50.51	190.5	94.44	849	643	1,780	1,350	2,530	1,920	5,800	3,690	1,350	1,820	2,090
.410	Yellow-poplar-yellow-poplar	.060	1.06	905	399	382	79.3	48.88	148.2	81.79	811	623	1,700	1,310	2,420	1,800	4,910	3,690	1,330	1,740	2,020
.410	Sweetgum-sweetgum	.060	1.26	973	434	413	107.2	66.31	183.6	110.79	874	674	2,000	1,550	2,100	6,400	4,900	1,460	1,860	2,070	2,450
.410	Sweetgum-yellow-poplar	.060	1.12	962	407	386	106.0	49.23	191.5	92.04	830	627	1,760	1,310	2,500	1,870	5,660	3,690	1,370	1,780	2,070
.410	Douglas-fir-Douglas-fir	.060	1.26	1,082	499	466	102.7	64.16	189.7	118.54	978	761	2,530	1,970	3,360	2,620	6,230	4,670	1,340	2,420	2,730
.400	Birch-birch	.068	1.82	1,340	593	567	165.0	101.84	327.9	202.35	1,202	924	2,710	2,090	3,840	2,950	8,630	6,470	1,630	2,700	3,300
.400	Birch-yellow-poplar	.068	1.37	1,286	418	391	158.4	62.51	314.7	116.87	1,000	632	2,090	1,320	2,980	1,800	6,770	3,690	1,350	1,820	2,320
.400	Mahogany-mahogany	.068	1.38	1,008	478	441	150.0	94.52	288.1	162.63	916	719	2,630	2,070	3,770	2,960	6,600	5,010	1,310	2,710	3,010
.400	Mahogany-yellow-poplar	.068	1.24	981	439	401	146.0	63.58	251.1	118.87	849	643	1,780	1,350	2,530	1,920	5,800	3,690	1,260	1,820	2,090
.400	Yellow-poplar-yellow-poplar	.068	1.19	905	399	382	92.8	61.53	186.6	115.63	811	623	1,700	1,310	2,420	1,800	4,910	3,690	1,240	1,740	2,020
.400	Sweetgum-sweetgum	.068	1.42	973	434	413	134.9	83.47	243.7	150.79	874	674	2,000	1,550	2,850	2,190	6,400	4,890	1,360	2,070	2,450
.400	Sweetgum-yellow-poplar	.068	1.25	962	407	386	133.4	61.97	211.0	115.86	830	627	1,760	1,310	2,500	1,870	5,660	3,690	1,280	1,780	2,070
.400	Douglas-fir-Douglas-fir	.068	1.42	1,082	499	466	129.3	80.70	238.9	149.21	978	761	2,530	1,970	3,360	2,620	6,230	4,670	1,250	2,420	2,730
.540	Birch-birch	.080	2.13	1,340	593	567	227.4	140.35	451.8	278.85	1,202	924	2,710	2,090	3,840	2,950	8,630	6,470	1,530	2,790	3,300
.540	Birch-yellow-poplar	.080	1.60	1,286	418	391	218.3	86.14	433.6	161.05	1,000	632	2,090	1,320	2,980	1,800	6,770	3,690	1,250	1,820	2,320
.540	Mahogany-mahogany	.080	1.62	1,008	478	441	206.7	130.25	355.7	224.12	916	719	2,630	2,070	3,770	2,960	6,600	5,010	1,210	2,710	3,010
.540	Mahogany-yellow-poplar	.080	1.45	981	439	401	201.1	87.62	346.1	163.82	849	643	1,780	1,350	2,530	1,920	5,800	3,690	1,160	1,820	2,090
.540	Yellow-poplar-yellow-poplar	.080	1.38	905	399	382	137.5	84.79	267.1	158.52	811	623	1,700	1,310	2,420	1,800	4,910	3,690	1,130	1,740	2,020
.540	Sweetgum-sweetgum	.080	1.66	973	434	413	185.9	115.63	335.8	207.80	874	674	2,000	1,550	2,850	2,190	6,400	4,890	1,270	2,070	2,450
.540	Sweetgum-yellow-poplar	.080	1.46	962	407	386	183.9	85.40	332.1	159.66	830	627	1,760	1,310	2,500	1,870	5,660	3,690	1,170	1,780	2,070
.540	Douglas-fir-Douglas-fir	.080	1.66	1,082	499	466	178.2	111.30	329.2	205.62	978	761	2,530	1,970	3,360	2,620	6,230	4,670	1,150	2,420	2,730

NINE-PLY (All plies of equal thickness)

0.500	Birch-birch	.068	2.34	1,250	675	652	255.0	178.0	506.6	353.6	1,171	955	2,640	2,150	3,740	3,050	8,390	6,710	1,660	2,870	3,270
.500	Birch-yellow-poplar	.068	1.89	1,176	619	627	238.3	170.6	473.4	339.0	944	708	1,980	1,670	2,810	2,360	7,220	5,270	1,440	2,220	2,480
.500	Mahogany-mahogany	.068	1.78	950	536	505	232.6	164.9	400.3	283.7	894	741	2,570	2,130	3,680	3,050	6,900	5,210	1,340	2,700	3,000
.500	Mahogany-yellow-poplar	.068	1.64	832	523	492	228.1	160.4	392.5	276.0	815	689	1,750	1,440	2,400	2,050	5,470	4,510	1,300	1,920	2,180
.500	Yellow-poplar-yellow-poplar	.068	1.53	850	454	440	154.2	107.6	288.3	201.0	790	644	1,660	1,360	2,360	1,920	4,780	3,820	1,270	1,790	2,010

See footnotes at end of table.

Table 2-13. Strength and elastic properties of plywood at 15 percent moisture content.—Continued

NINE-PLY (All plies of equal thickness)—Continued

Nominal thickness	Species ¹	Veneer thickness ²	Plywood weight (lb per cent moisture) ³	Static bending						Compression						Ultimate strength in shear									
				Modulus of elasticity			Moment for fiber stress at proportional limit			Moment for modulus of rupture			Modulus of elasticity ⁴			Fiber stress at proportional limit			Maximum crushing strength		Ultimate strength in tension				
				$E_{1/2}$	$E_{1/3}$	$E_{1/4}$	Parallel ³	Perpendicular ³	In.-lb. per in. of width	Parallel ³	Perpendicular ³	In.-lb. per in. of width	Parallel ³	Perpendicular ³	In.-lb. per in. of width	E_x	E_y	E_z	$F_{1/2}$	$F_{1/3}$	$F_{1/4}$	$F_{1/2}$	$F_{1/3}$	$F_{1/4}$	$F_{1/2}$
(1)	(2)	(3)	(4)	(5)	(6)	(7)	(8)	(9)	(10)	(11)	(12)	(13)	(14)	(15)	(16)	(17)	(18)	(19)	(20)	(21)	(22)				
.580	Sweetgum-sweetgum	.068	1.83	1,000	1,000	1,000	In.-lb. per in. of width	In.-lb. per in. of width	In.-lb. per in. of width	In.-lb. per in. of width	1,000	1,000	P. s. i.	P. s. i.	P. s. i.	P. s. i.	P. s. i.	P. s. i.	P. s. i.	P. s. i.	P. s. i.	P. s. i.	P. s. i.	P. s. i.	P. s. i.
.580	Sweetgum-yellow-poplar	.068	1.83	914	493	475	208.5	145.8	376.7	263.4	882	696	1,950	1,400	2,770	2,270	4,980	4,980	1,400	1,400	1,400	1,400	1,400	1,400	1,400
.580	Douglas-fir-Douglas-fir	.068	1.83	1,018	562	535	200.2	141.0	369.8	260.4	954	785	2,470	2,030	3,280	2,700	6,050	4,840	1,280	1,280	1,280	1,280	1,280	1,280	1,280
.695	Birch-birch	.080	2.71	1,259	675	652	353.8	246.9	703.0	490.6	1,171	955	2,640	2,150	3,740	3,050	8,390	6,710	1,550	1,550	1,550	1,550	1,550	1,550	1,550
.695	Birch-yellow-poplar	.080	2.21	1,176	649	627	330.0	236.8	656.9	470.4	944	798	1,980	1,670	2,810	2,380	6,220	5,270	1,330	1,330	1,330	1,330	1,330	1,330	1,330
.695	Mahogany-mahogany	.080	2.08	950	536	505	322.8	228.8	555.4	383.6	894	741	2,570	2,130	3,050	2,500	5,290	4,470	1,200	1,200	1,200	1,200	1,200	1,200	1,200
.695	Mahogany-yellow-poplar	.080	1.91	932	523	492	316.5	222.6	544.6	383.0	835	689	1,750	1,410	2,490	2,050	5,470	4,510	1,190	1,190	1,190	1,190	1,190	1,190	1,190
.695	Yellow-poplar-yellow-poplar	.080	1.78	850	454	440	213.9	149.2	400.0	278.9	700	644	1,660	1,350	2,360	1,920	4,780	3,820	1,050	1,050	1,050	1,050	1,050	1,050	1,050
.695	Sweetgum-sweetgum	.080	2.14	914	476	458	289.4	202.3	522.7	365.5	852	696	1,950	1,600	2,770	2,270	6,220	4,980	1,200	1,200	1,200	1,200	1,200	1,200	1,200
.695	Sweetgum-yellow-poplar	.080	1.94	901	468	450	285.3	200.1	515.4	361.5	815	669	1,710	1,400	2,430	2,000	5,360	4,400	1,220	1,220	1,220	1,220	1,220	1,220	1,220
.695	Douglas-fir-Douglas-fir	.080	2.14	1,018	562	535	277.8	195.6	513.2	361.4	954	785	2,470	2,030	3,280	2,700	6,000	4,840	1,170	1,170	1,170	1,170	1,170	1,170	1,170

ELLYVEN-PLY (all plies of equal thickness)

0.850	Birch-birch	.080	3.35	1,206	727	708	507.2	382.0	1,097.7	750.0	1,152	975	2,600	2,200	3,080	2,510	8,240	6,800	1,560	1,560	1,560	1,560	1,560	1,560	1,560
.850	Birch-yellow-poplar	.080	2.60	1,094	677	658	490.0	354.2	914.0	703.8	903	783	1,830	1,610	2,600	2,140	5,870	5,000	1,310	1,310	1,310	1,310	1,310	1,310	1,310
.850	Mahogany-mahogany	.080	2.54	913	573	547	463.9	353.8	798.3	608.7	890	755	1,530	1,270	3,620	3,110	6,380	5,320	1,240	1,240	1,240	1,240	1,240	1,240	1,240
.850	Mahogany-yellow-poplar	.080	2.31	887	553	529	450.4	340.1	775.0	585.1	813	694	1,700	1,450	2,430	2,070	4,470	3,910	1,200	1,200	1,200	1,200	1,200	1,200	1,200
.850	Yellow-poplar-yellow-poplar	.080	2.18	814	490	477	306.6	230.8	573.3	431.5	777	657	1,630	1,380	2,320	1,930	4,690	3,910	1,170	1,170	1,170	1,170	1,170	1,170	1,170
.850	Sweetgum-sweetgum	.080	2.62	876	531	516	414.0	313.0	749.5	565.4	837	710	1,920	1,630	2,780	2,310	6,110	5,090	1,310	1,310	1,310	1,310	1,310	1,310	1,310
.850	Sweetgum-yellow-poplar	.080	2.34	850	522	507	406.6	307.3	734.6	555.2	798	678	1,670	1,420	2,380	2,020	5,190	4,380	1,220	1,220	1,220	1,220	1,220	1,220	1,220
.850	Douglas-fir-Douglas-fir	.080	2.62	977	603	580	398.8	302.5	736.8	558.9	938	800	2,430	2,070	3,230	2,750	6,950	4,050	1,180	1,180	1,180	1,180	1,180	1,180	1,180
1.010	Birch-birch	.095	3.96	1,206	727	708	716.1	530.4	1,422.8	1,071.6	1,152	975	2,600	2,200	3,080	2,510	8,240	6,800	1,460	1,460	1,460	1,460	1,460	1,460	1,460
1.010	Birch-yellow-poplar	.095	3.07	1,094	677	658	649.5	500.2	1,290.5	903.7	903	783	1,830	1,610	2,600	2,140	5,870	5,000	1,210	1,210	1,210	1,210	1,210	1,210	1,210
1.010	Mahogany-mahogany	.095	3.00	913	573	547	655.1	490.5	1,127.1	850.4	880	755	1,530	1,270	3,620	3,110	6,390	5,320	1,140	1,140	1,140	1,140	1,140	1,140	1,140
1.010	Mahogany-yellow-poplar	.095	2.72	887	553	529	635.9	480.1	1,094.2	826.1	813	694	1,700	1,450	2,430	2,070	4,470	3,910	1,090	1,090	1,090	1,090	1,090	1,090	1,090
1.010	Yellow-poplar-yellow-poplar	.095	2.56	814	490	477	432.9	325.9	860.2	600.2	777	657	1,630	1,380	2,320	1,930	4,690	3,910	1,070	1,070	1,070	1,070	1,070	1,070	1,070
1.010	Sweetgum-sweetgum	.095	3.09	876	531	516	585.8	441.9	1,088.3	798.3	837	710	1,920	1,630	2,780	2,310	6,110	5,090	1,200	1,200	1,200	1,200	1,200	1,200	1,200
1.010	Sweetgum-yellow-poplar	.095	2.75	850	522	507	574.1	433.9	1,037.1	783.8	798	678	1,670	1,420	2,380	2,020	5,190	4,380	1,120	1,120	1,120	1,120	1,120	1,120	1,120
1.010	Douglas-fir-Douglas-fir	.095	3.09	977	603	580	563.1	427.2	1,040.3	780.2	938	800	2,430	2,070	3,230	2,750	6,950	4,050	1,080	1,080	1,080	1,080	1,080	1,080	1,080

¹ Grain direction of adjacent plies at right angles; all veneer rotary cut, except Douglas-fir and mahogany, which are quarter sliced.

² Constructions and veneer thickness taken from Specification AN-P-69A (Plywood and Veneer: Aircraft Flat Panel). In determining the values in this table, the veneer thicknesses were reduced proportionately so that their sums equalled the nominal plywood thickness, except in computing the weight per square foot of panel. A weight of 0.012 pound per square foot of glue line was allowed.

³ Parallel and perpendicular refer to the relation between the grain direction of the face plies and the direction of the span. In panels, the direction of the span will be determined by the direction of the plywood strip being considered.

⁴ The values of E_x and E_y apply also to tension. In this column F indicates face; B, back; and C, core.

been based on the average specific gravity values for wood listed in table 2-6.

The strength properties for a piece of plywood are merely the composite strengths of each individual veneer in the direction being considered. Therefore, to make a rational specific gravity correction to plywood strength test data, it is first necessary to determine the specific gravity of each individual veneer and then correct its strength properties to correspond to the average specific gravity value given in table 2-6 for that species. To do this, of course, is impractical and the problem is further complicated by the effect of glue impregnation.

When substantiating the strength of a plywood structure, or when establishing design values from static tests, the weight per square foot of the plywood used in the specimens should be near the values given in table 2-13 to minimize the effect of high or low specific gravity values (ref. 2-22).

2.56. STRESS-STRAIN RELATIONS FOR WOOD AND PLYWOOD. When stresses are applied to wood

$$a_{22} = \frac{\sin^4 \theta}{E_w} + \frac{\cos^4 \theta}{E_x} + \left[\frac{1}{G_{wx}} - \frac{2\mu_{wx}}{E_w} \right] \sin^2 \theta \cos^2 \theta$$

$$a_{33} = 4 \left[\frac{1}{E_w} + \frac{1}{E_x} + \frac{2\mu_{wx}}{E_w} \right] \sin^2 \theta \cos^2 \theta + \frac{1}{G_{wx}} [\cos^2 \theta - \sin^2 \theta]^2$$

$$a_{21} = a_{12} = \left[\frac{1}{E_w} + \frac{1}{E_x} - \frac{1}{G_{wx}} \right] \sin^2 \theta \cos^2 \theta - \frac{\mu_{wx}}{E_w} [\sin^4 \theta + \cos^4 \theta]$$

$$a_{31} = a_{13} = \left[\frac{1}{G_{wx}} - \frac{2\mu_{wx}}{E_w} - \frac{2}{E_x} \right] \sin \theta \cos^3 \theta - \left[\frac{1}{G_{wx}} - \frac{2\mu_{wx}}{E_w} - \frac{2}{E_x} \right] \sin^3 \theta \cos \theta$$

$$a_{32} = a_{23} = \left[\frac{1}{G_{wx}} - \frac{2\mu_{wx}}{E_w} - \frac{2}{E_x} \right] \sin^3 \theta \cos \theta - \left[\frac{1}{G_{wx}} - \frac{2\mu_{wx}}{E_w} - \frac{2}{E_x} \right] \sin \theta \cos^3 \theta$$

where θ is measured positively from the direction of the face grain of the plywood to the direction of axis 1, as shown in figure 2-12.

The inverses of equations (2:26) are:

$$f_1 = b_{11}e_1 + b_{12}e_2 + b_{13}e_{s12}$$

$$f_2 = b_{21}e_1 + b_{22}e_2 + b_{23}e_{s12} \quad (2:35)$$

$$f_{s12} = b_{31}e_1 + b_{32}e_2 + b_{33}e_{s12}$$

in which

$$b_{11} = \frac{1}{\lambda} [E_w \cos^4 \theta + E_x \sin^4 \theta + (2E_w \mu_{wx} + 4\lambda G_{wx}) \sin^2 \theta \cos^2 \theta]$$

$$b_{22} = \frac{1}{\lambda} [E_x \cos^4 \theta + E_w \sin^4 \theta + (2E_w \mu_{wx} + 4\lambda G_{wx}) \sin^2 \theta \cos^2 \theta]$$

$$b_{33} = \frac{1}{\lambda} (E_w + E_x - 2E_w \mu_{wx}) \sin^2 \theta \cos^2 \theta + G_{wx} (\cos^2 \theta - \sin^2 \theta)^2$$

or plywood in a direction at an angle to the grain, the resulting strains are quite different from those obtained in isotropic materials. The general equations (ref. 2-52 and 2-53) relating the strains to the stresses shown in figure 2-12 are:

$$\begin{aligned} e_1 &= a_{11}f_1 + a_{12}f_2 + a_{13}f_{s12} \\ e_2 &= a_{21}f_1 + a_{22}f_2 + a_{23}f_{s12} \\ e_{s12} &= a_{31}f_1 + a_{32}f_2 + a_{33}f_{s12} \end{aligned} \quad (2:34)$$

in which the stresses and strains are referred to orthogonal axes 1 and 2.

f_1 and e_1 are stress and strain in the direction of axis 1.

f_2 and e_2 are stress and strain in the direction of axis 2.

f_{s12} and e_{s12} are shear stress and shear strain associated with the directions of axes 1 and 2, and in which:

$$a_{11} = \frac{\sin^4 \theta}{E_x} + \frac{\cos^4 \theta}{E_w} + \left[\frac{1}{G_{wx}} - \frac{2\mu_{wx}}{E_w} \right] \sin^2 \theta \cos^2 \theta$$

$$b_{21} = b_{12} = \frac{1}{\lambda} [(E_v + E_x - 4\lambda G_{vx}) \sin^2 \theta \cos^2 \theta + E_v \mu_{zv} (\cos^4 \theta + \sin^4 \theta)]$$

$$b_{31} = b_{13} = \frac{1}{\lambda} [(E_x - E_v \mu_{zv} - 2\lambda G_{vx}) \sin^3 \theta \cos \theta - (E_v - E_v \mu_{zv} - 2\lambda G_{vx}) \sin \theta \cos^3 \theta]$$

$$b_{32} = b_{23} = \frac{1}{\lambda} [(E_x - E_v \mu_{zv} - 2\lambda G_{vx}) \sin \theta \cos^3 \theta - (E_v - E_v \mu_{zv} - 2\lambda G_{vx}) \sin^3 \theta \cos \theta]$$

$$\lambda = 1 - \mu_{vx} \mu_{zv}$$

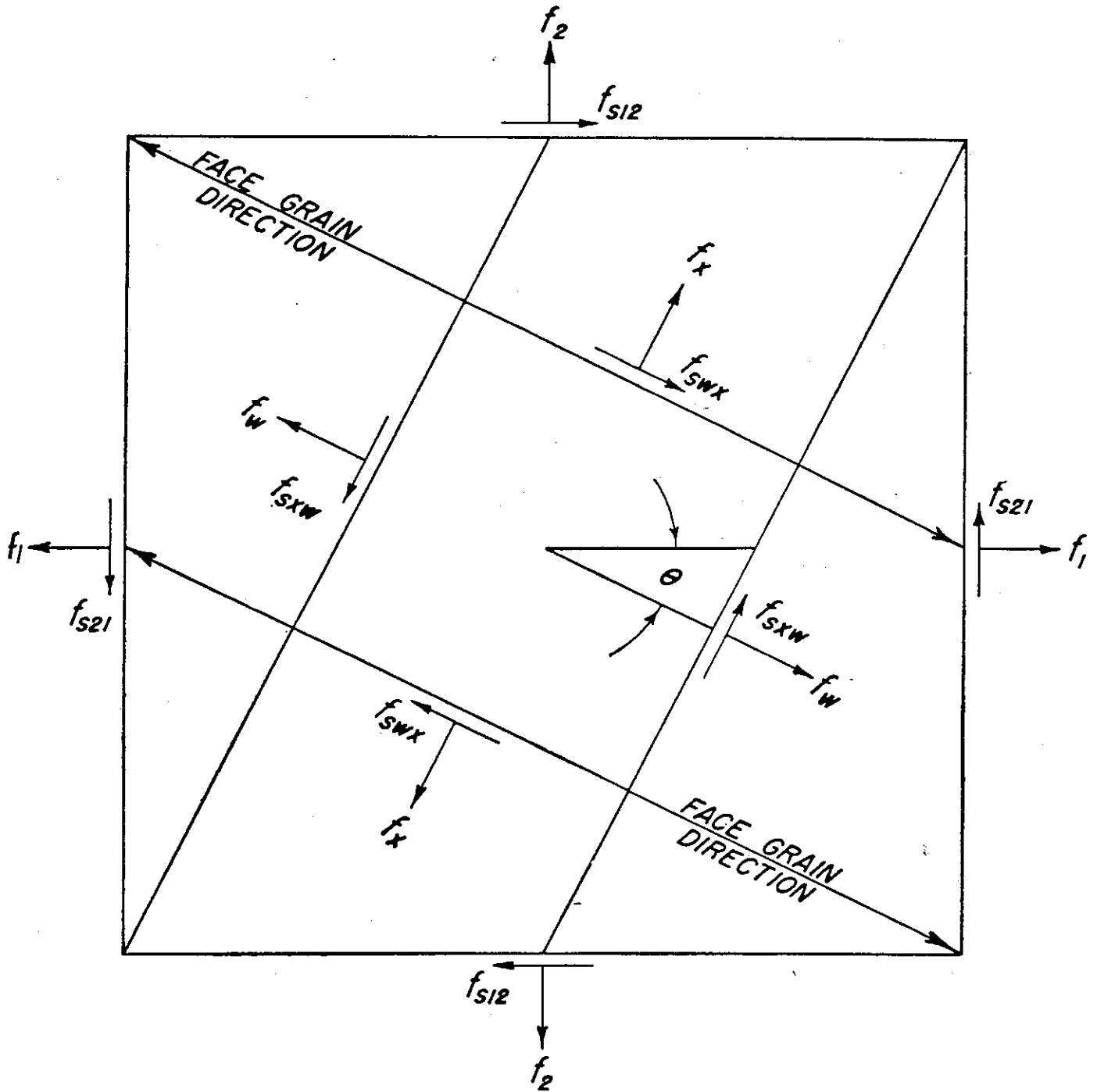

Figure 2-12. General stress distribution in plywood.

If the stresses are known, equations (2:34) completely define the strains. For example, if the plywood is subjected only to a tensile stress f_1 applied at an angle θ to the direction of the face grain, then $f_2=f_{s12}=0$ and equations (2:34) reduce to:

$$\begin{aligned} e_1 &= a_{11} f_1 \\ e_2 &= a_{21} f_1 \\ e_{s12} &= a_{31} f_1 \end{aligned}$$

If the strains are known, equations (2:35) completely define the stresses in a like manner.

The usual transformation equations for stresses and strains apply. The transformation from the arbitrary coordinate system 1, 2 to that of I, II is given by

$$\begin{aligned} f_I &= f_1 \cos^2 \theta + f_2 \sin^2 \theta + 2f_{s12} \sin \theta \cos \theta \\ f_{II} &= f_1 \sin^2 \theta + f_2 \cos^2 \theta - 2f_{s12} \sin \theta \cos \theta \\ f_{sII} &= -f_1 \sin \theta \cos \theta + f_2 \sin \theta \cos \theta + f_{s12} (\cos^2 \theta - \sin^2 \theta) \end{aligned} \quad (2:36)$$

and

$$\begin{aligned} e_I &= e_1 \cos^2 \theta + e_2 \sin^2 \theta + e_{s12} \sin \theta \cos \theta \\ e_{II} &= e_1 \sin^2 \theta + e_2 \cos^2 \theta - e_{s12} \sin \theta \cos \theta \\ e_{sII} &= -2e_1 \sin \theta \cos \theta + 2e_2 \sin \theta \cos \theta + e_{s12} (\cos^2 \theta - \sin^2 \theta) \end{aligned} \quad (2:37)$$

where θ is measured positively from the 01 axis to the 0I axis, as shown in figure 2-13.

Very often the linear strains in three arbitrary directions are known rather than those given in equations (2:34) and (2:35). The required strains can be found by use of the first of equations (2:37) for each of the directions shown in figure 2-14.

The following equations result:

$$\begin{aligned} e_{s12} &= \frac{\frac{e_3}{\sin^2 \theta_3} - \frac{e_4}{\sin^2 \theta_4} - e_1 \left[\frac{\cos^2 \theta_3}{\sin^2 \theta_3} - \frac{\cos^2 \theta_4}{\sin^2 \theta_4} \right]}{\frac{\cos \theta_3}{\sin \theta_3} - \frac{\cos \theta_4}{\sin \theta_4}} \\ e_2 &= \frac{\frac{e_3}{\sin \theta_3 \cos \theta_3} - \frac{e_4}{\sin \theta_4 \cos \theta_4} - e_1 \left[\frac{\cos \theta_3}{\sin \theta_3} - \frac{\cos \theta_4}{\sin \theta_4} \right]}{\frac{\sin \theta_3}{\cos \theta_3} - \frac{\sin \theta_4}{\cos \theta_4}} \end{aligned} \quad (2:38)$$

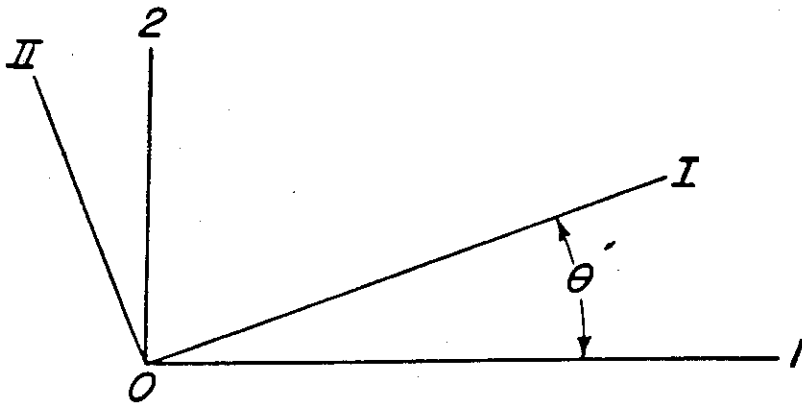

Figure 2-13. Axes for transformation equations.

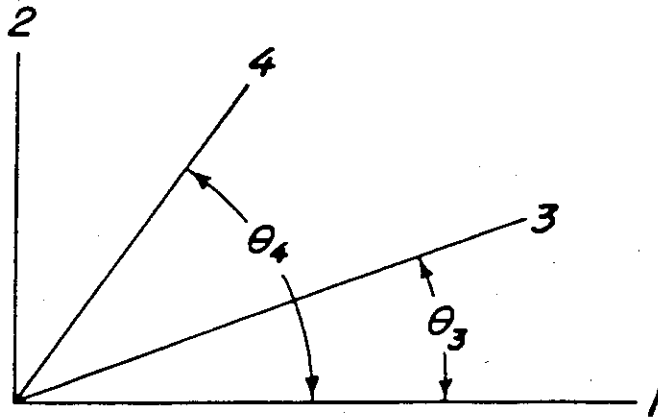

Figure 2-14. Arbitrary directions in which linear strains are known.

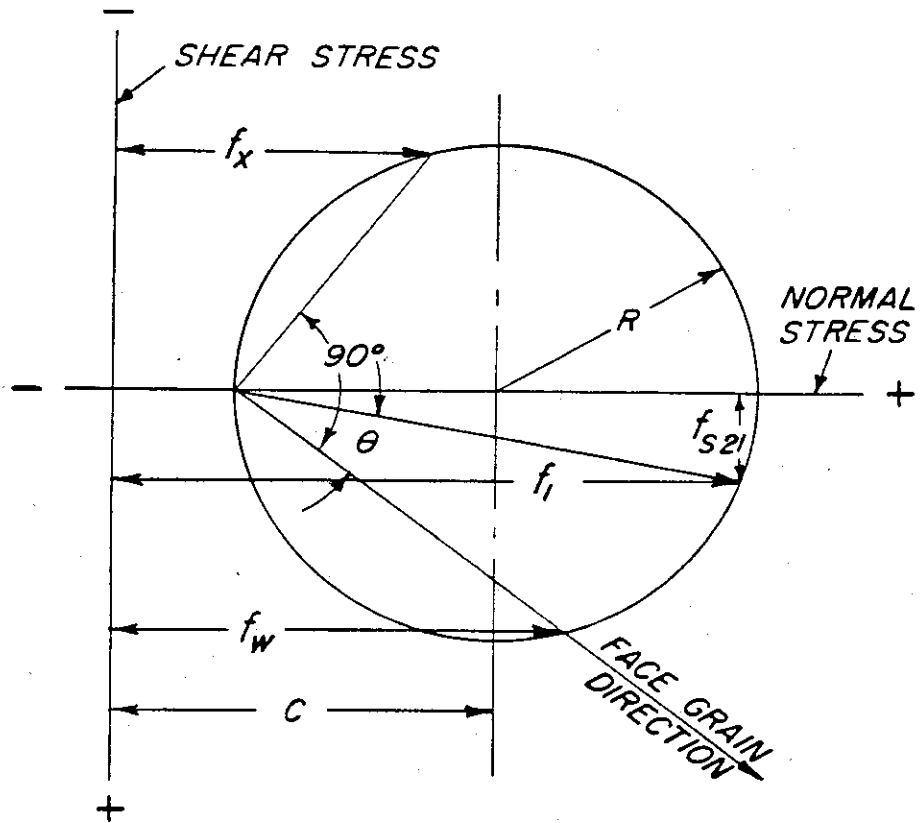

Figure 2-15. Stress circle for stresses shown in figure 2-12.

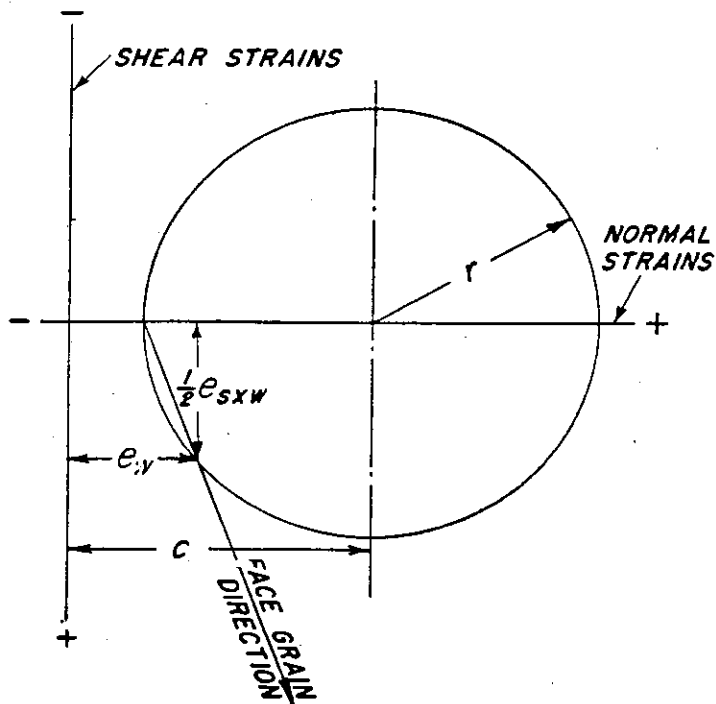

Figure 2-16. Strain circle resulting from equation (2:41).

and if

$$\theta_3 = 45^\circ \text{ and } \theta_4 = 90^\circ,$$

$$e_{s12} = 2e_3 - e_4 - e_1, \quad e_2 = e_4$$

2.560. *Mohr's stress-and-strain circles.* Mohr's stress-and-strain circles are a means of showing, graphically, the relation of stress or strain in one direction to the stress or strain in any other direction and are an aid in the visualization and evaluation of these relations. Reference 2-65 treats extensively the general problem of the use of Mohr's circles in connection with wood and plywood. Only a limited general treatment is presented herein.

2.5600. *Obtaining strains from given stresses.* Assume a stress distribution in a piece of plywood as shown upon the outer square in figure 2-12 (direction of arrows indicates positive direction). The stress circle can be drawn by use of the following equations as shown in figure 2-15, and the stresses parallel and perpendicular to the face grain direction can be determined.

$$C = \frac{1}{2}(f_1 + f_2) \quad (2:39)$$

$$R = \sqrt{(f_1 - C)^2 + (f_{s21})^2} \quad (2:40)$$

The strains parallel and perpendicular to the face grain direction can be found by use of the equations

The stresses parallel and perpendicular to the face grain direction can be obtained from the following equations:

$$f_w = E_x \frac{e_w + e_x \mu_{xw}}{1 - (\mu_{wx} \mu_{xw})} \quad f_x = E_x \frac{e_x + e_w \mu_{wx}}{1 - (\mu_{wx} \mu_{xw})} \quad f_{sww} = G_{wx} e_{sww} \quad (2:45)$$

The stress circle can then be drawn, by the use of the following equations, as shown in figure 2-19, and the stress at any angle to the face grain direction may be found:

$$C = \frac{1}{2}(f_w + f_x) \quad (2:46)$$

$$R = \sqrt{(f_w - C)^2 + (f_{sww})^2} \quad (2:47)$$

2.5602. *Experimental stress-strain data.* Figures 2-20, 2-21, and 2-22 present stress-strain curves of five-ply yellow-poplar plywood subjected to tension, compression, and shear, respectively, at var-

$$e_w = \frac{f_w}{E_w} - \frac{f_x}{E_x} \mu_{xw} \quad e_x = \frac{f_x}{E_x} - \frac{f_w}{E_w} \mu_{wx} \quad e_{sww} = \frac{f_{sww}}{G_{wx}} \quad (2:41)$$

where μ_{wx} and μ_{xw} are given by equations (2:30) and (2:31), respectively.

The strain circle can then be drawn, by the following equations, as shown in figure 2-16 and the strains in any direction can be determined.

$$c = \frac{1}{2}(e_w + e_x) \quad (2:42)$$

$$r = \sqrt{(e_w - c)^2 + \left(\frac{e_{sww}}{2}\right)^2} \quad (2:43)$$

2.5601. *Obtaining stresses from given strains.* The foregoing process can be reversed if strains are given and stresses required. For this purpose strains are usually measured in the three directions shown in figure 2-17. The strain circle can be drawn, by use of the following equations, as shown in figure 2-18, and the strains parallel and perpendicular to the face grain can be found.

$$c = \frac{1}{2}(e_1 + e_2)$$

$$r = \sqrt{\frac{1}{2}(e_1 - e_3)^2 + \frac{1}{2}(e_2 - e_3)^2} \quad (2:44)$$

ious angles to the face grain. These figures are reproduced from reference 2-67.

2.57. STRESS CONCENTRATIONS. (See sections 2-16-2.1611)

2.6. Plywood Structural Elements

The following formulas for strength of plywood elements are applicable only when elastic instability (buckling) is not involved, except in the case of column formulas. For cases involving buckling, see section 2.71.

2.60. ELEMENTS $\theta = (0^\circ \text{ or } 90^\circ)$.

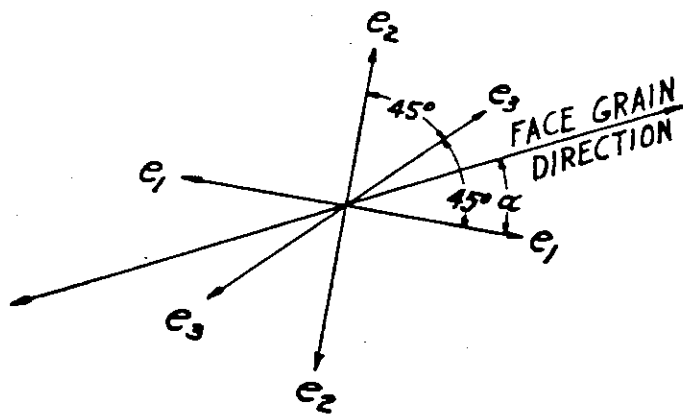

Figure 2-17. Directions of measured strains.

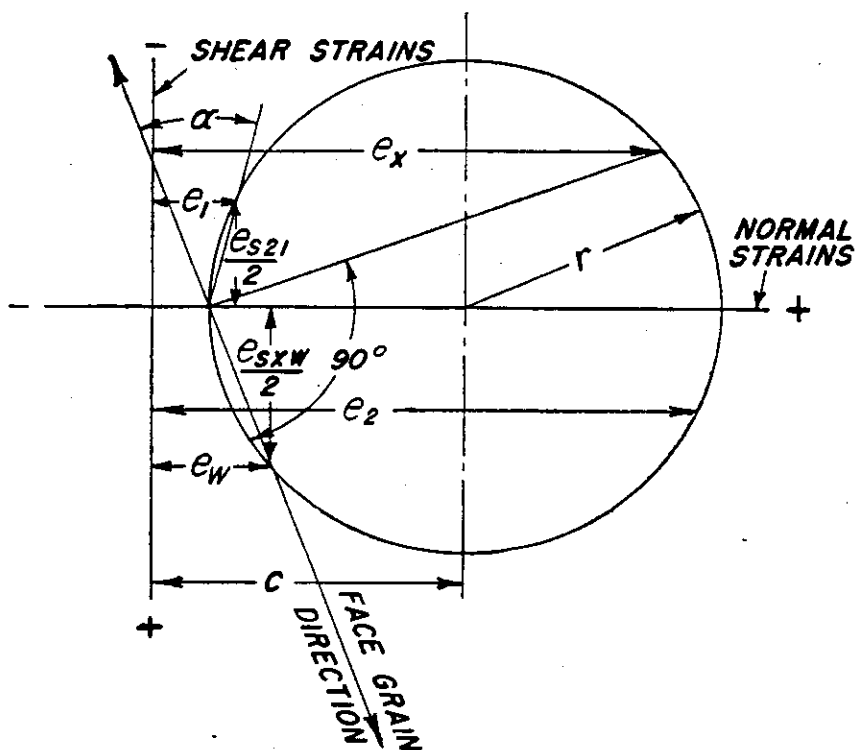

Figure 2-18. Strain circle for measured strains.

2.600. *Elements in compression* ($\theta=0^\circ$ or 90°). When a plywood prism is subjected to a direct compression load, the relation between the internal stress (f_{cL}) in any longitudinal ply and the average P/A stress is given by the following equations: (Ref. 2-43)

Face grain parallel to applied load

$$P/A = f_{cw} = \frac{E_w}{E_{Lc}} f_{cL} \quad (2:48)$$

Face grain perpendicular to applied load

$$P/A = f_{cx} = \frac{E_x}{E_{Lc}} f_{cL} \quad (2:49)$$

The allowable stresses at the proportional limit F_{cpw} and F_{cpz} or the allowable ultimate stresses F_{cuw} and F_{cuz} are obtained from these equations, respectively, when the stress at the proportional limit F_{cp} or the ultimate crushing stress F_{cu} from tables 2-6 or 2-7, whichever is required, is substituted for f_{cL} . When more than one species is used in the longitudinal plies, the species having the lowest ratio of F_{cp}/E_L and F_{cu}/E_L must be used in determining the correct allowables. For certain species and plywood constructions, the compression allowables for the 15 percent moisture content condition may be obtained from table 2-13.

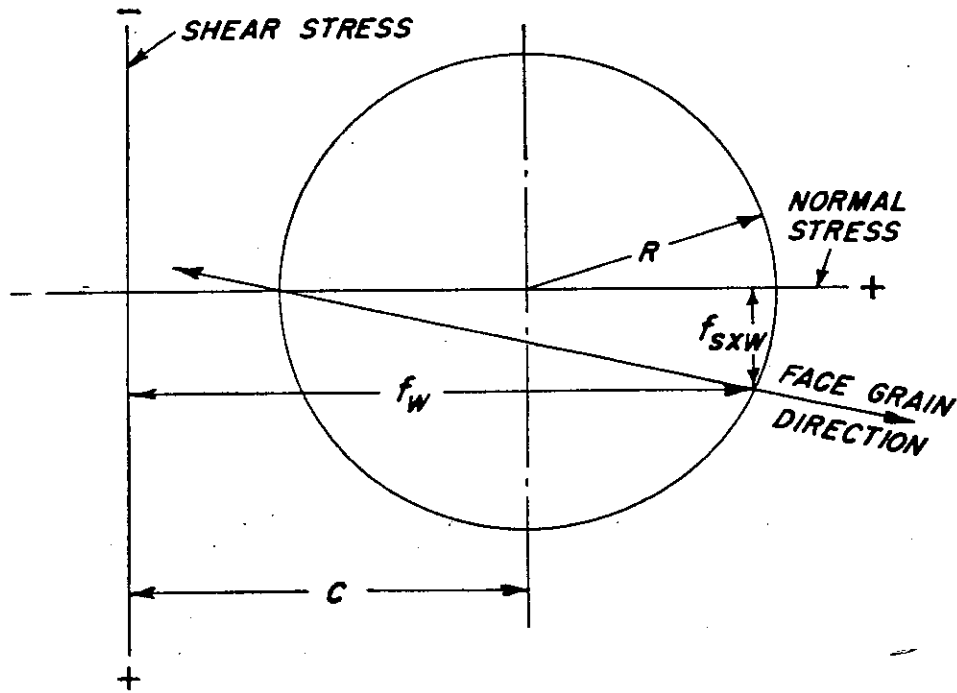

Figure 2-19. Stress circle resulting from equations (2:45)

2.601. *Elements in tension* ($\theta=0^\circ$ or 90°). The allowable ultimate tensile stress for a plywood strip (designated as F_{tuw} when the face grain direction is parallel to the applied load, and F_{tuz} when the face grain is perpendicular to the applied load) is equal to the sum of the strengths of the longitudinal plies divided by the total area of the cross section. The strength of any longitudinal ply is equal to its area multiplied by the modulus of rupture for the species of that ply as given in column 8 of tables 2-6 and 2-7. For certain species and plywood constructions, the tension allowables may be obtained from table 2-13.

2.602. *Elements in shear* ($\theta=0^\circ$ or $\theta=90^\circ$). The allowable ultimate stress of plywood elements subjected to shear is given by the empirical formula: (Ref. 2-88)

$$F_{szx} = 55 \frac{n-1}{t} + \frac{9}{16t} \sum_{i=0}^{i=n} F_{sui} t_i \quad (2:50)$$

in which the factor $\frac{n-1}{t}$ shall not be assigned values greater than 35 and in which t_i is the thickness of the i^{th} ply and F_{sui} is the shear strength of wood of the i^{th} ply obtained from tables 2-6 or 2-7. For certain species and plywood constructions the shear allowables for the 15 percent moisture content condition may be obtained from table 2-13.

2.61. ELEMENTS (θ =ANY ANGLE).

2.610. *Elements in compression* (θ =any angle). Based upon the results of compression tests of a few species and constructions of plywood, the ultimate compressive stress of narrow elements may be given by:

$$F_{cu\theta} = \frac{1}{\sqrt{\left[\frac{\cos^2\theta}{F_{cuw}}\right]^2 + \left[\frac{\sin^2\theta}{F_{cuz}}\right]^2 + \left[\frac{\sin\theta\cos\theta}{F_{szx}}\right]^2}} \quad (2:51)$$

and the ultimate compressive stress of wide elements, by:

$$F_{cu\theta} = \sqrt{F_{cuw}^2 \cos^4\theta + F_{cuz}^2 \sin^4\theta + 4F_{szx}^2 \sin^2\theta \cos^2\theta} \quad (2:52)$$

where

θ =angle between the face grain and the direction of the applied load.

F_{cuw} =ultimate compressive strength of the plywood parallel to the face grain; from formula (2:48).

F_{cuz} =ultimate compressive strength of the plywood perpendicular to the face grain; from formula (2:49).

F_{szx} =ultimate shear strength of the plywood when the face grain direction is parallel and perpendicular to the shear stresses, from section 2.602.

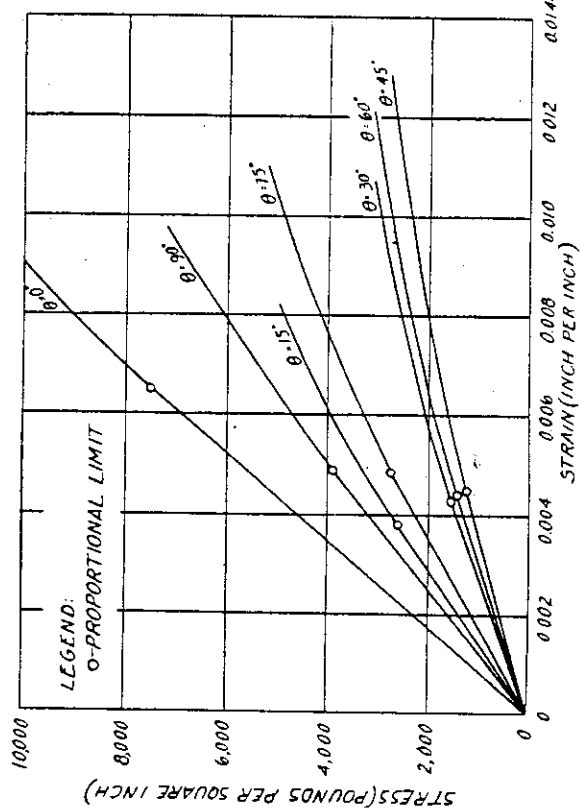
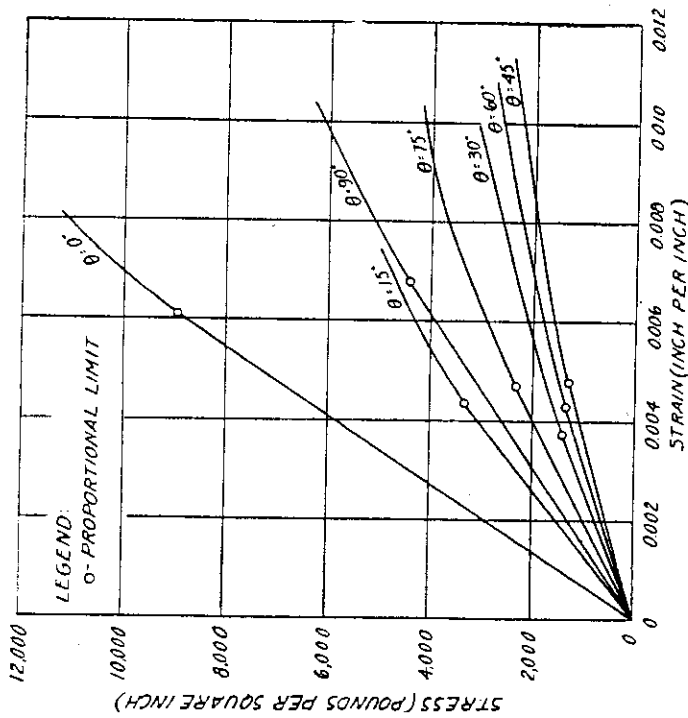

Figure 2-20. Tension tests on yellow-poplar plywood at various angles to the face grain. Plywood was made of five $\frac{1}{8}$ -inch plies. Each curve represents values from 16 tests on specimens 0.8 inches in width.

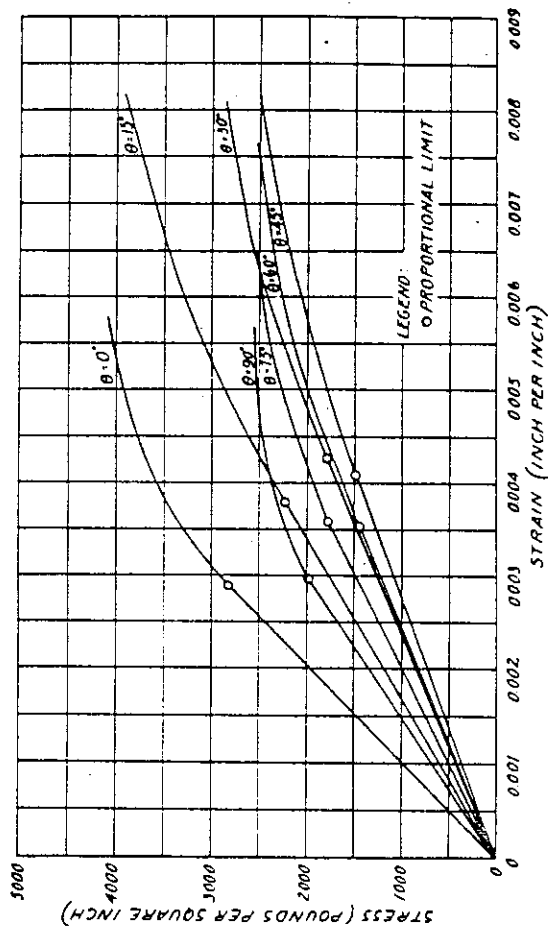
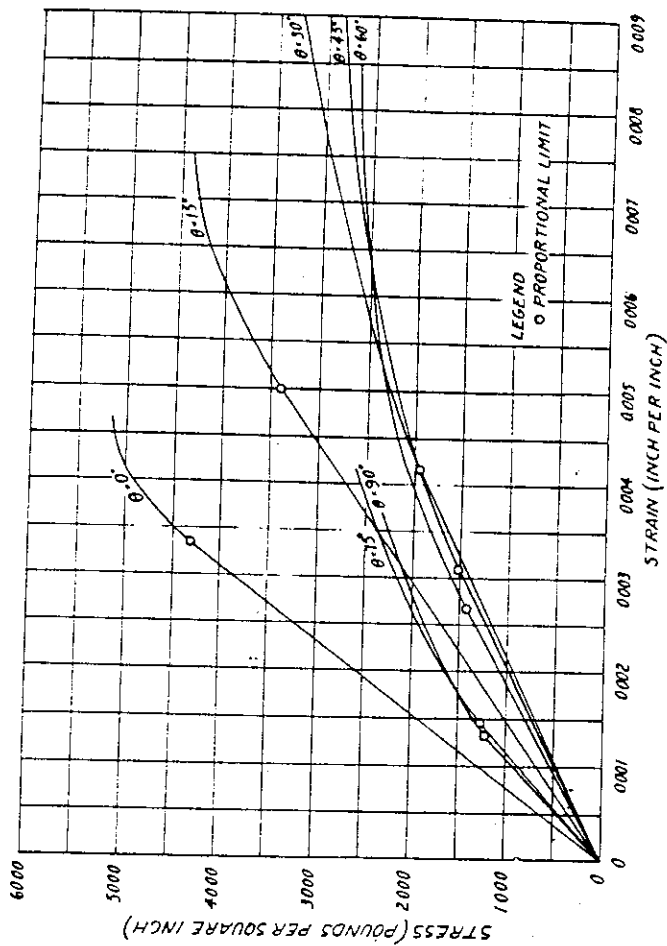

Figure 2-21. Stress-strain curves from compression tests on yellow-poplar plywood at various angles to the face grain. Plywood was made of five $\frac{1}{8}$ -inch plies. Each curve represents values from four tests on specimens 6 inches in width.

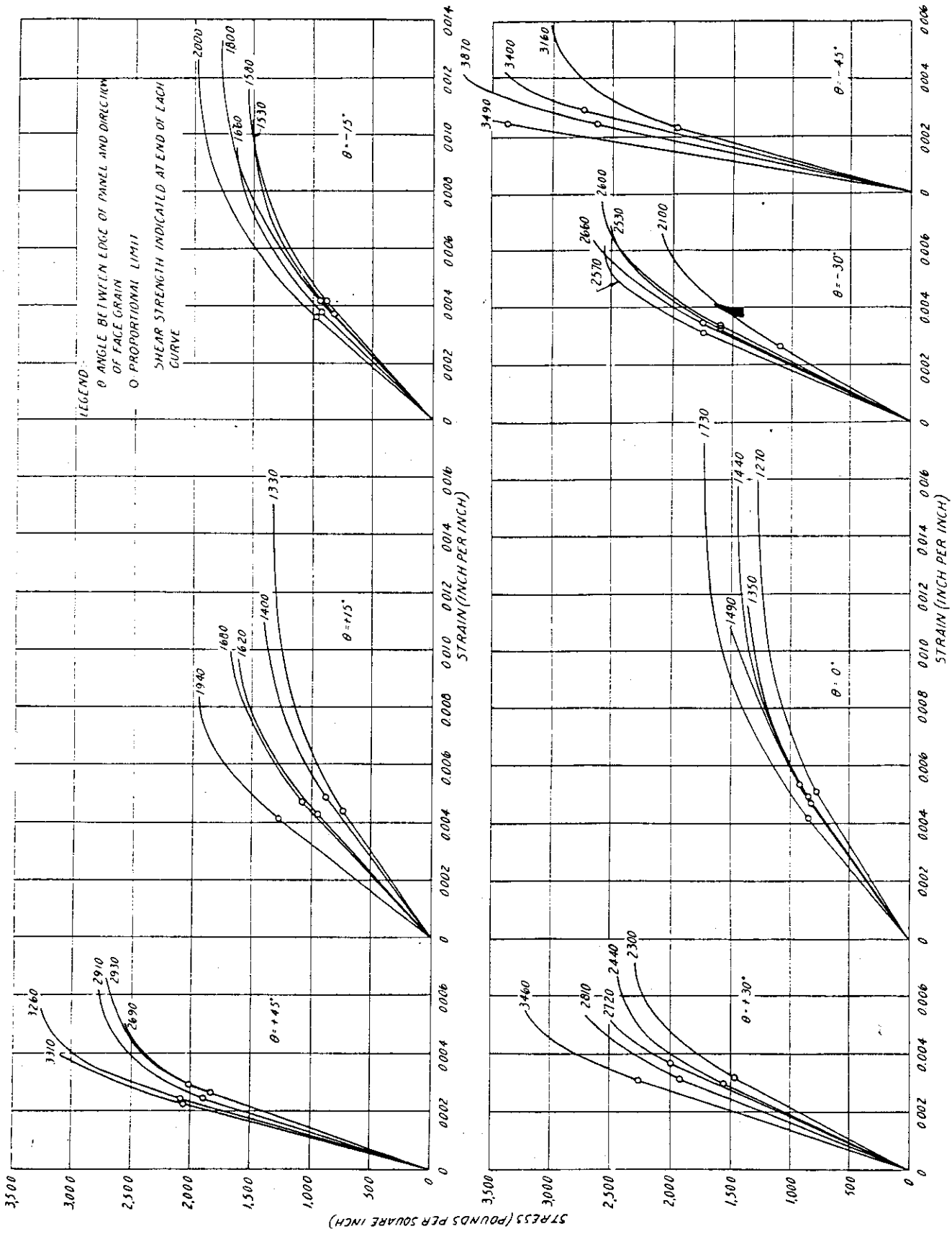

Figure 2-22. Panel shear tests on yellow-poplar plywood loaded at various angles to the face grain. Strains were measured on the principal axis of compression. Construction was five plies of 1/16-inch veneer.

2.611. *Elements in tension* (θ =any angle). The ultimate tensile strength of narrow elements is given by the formula:

$$F_{tu\theta} = \frac{1}{\sqrt{\left[\frac{\cos^2\theta}{F_{tuw}}\right]^2 + \left[\frac{\sin^2\theta}{F_{tuz}}\right]^2 + \left[\frac{\sin\theta \cos\theta}{F_{suw}}\right]^2}} \quad (2:53)$$

and the tensile strength of wide elements, by

$$F_{tu\theta} = \sqrt{F_{tuw}^2 \cos^4\theta + F_{tuz}^2 \sin^4\theta + 4F_{suw} \sin^2\theta \cos^2\theta} \quad (2:54)$$

where

F_{tuw} and F_{tuz} =ultimate tensile strength of plywood parallel and perpendicular to the face grain direction, respectively, from section 2.601.

2.612. *Elements in shear* (θ =any angle). The ultimate shear strength of plywood in this case is given by equations (2:55) and (2:56). When shear tends to place the face grain in tension, equation (2:55) should be used. When shear tends to place the face grain in compression, equation (2:56) should be used.

When face grain is in tension

$$F_{s\theta t} = \frac{1}{\sqrt{\left(\frac{1}{F_{tuw}^2} + \frac{1}{F_{cuw}^2}\right) \sin^2 2\theta + \frac{\cos^2 2\theta}{F_{suw}^2}}} \quad (2:55)$$

When face grain is in compression

$$F_{s\theta c} = \frac{1}{\sqrt{\left(\frac{1}{F_{cuw}^2} + \frac{1}{F_{tuz}^2}\right) \sin^2 2\theta + \frac{\cos^2 2\theta}{F_{suw}^2}}} \quad (2:56)$$

For the special case of the face grain at 45° to the side of the panel, equations (2:55) and (2:56) reduce to

$$F_{s45t} = \frac{F_{tuw}}{\sqrt{1 + \left(\frac{F_{tuw}}{F_{cuw}}\right)^2}} \quad (2:57)$$

$$F_{s45c} = \frac{F_{tuz}}{\sqrt{1 + \left(\frac{F_{tuz}}{F_{cuw}}\right)^2}} \quad (2:58)$$

2.613. *Elements in combined compression (or tension) and shear* (θ =any angle). The condition

for failure of plywood elements subjected to combined stresses in the plane of the plywood is given by the following equation. Formulas (2:53) to (2:58) are special cases of this general equation.

$$\left(\frac{f_w}{F_w}\right)^2 + \left(\frac{f_z}{F_z}\right)^2 + \left(\frac{f_{suw}}{F_{suw}}\right)^2 = 1 \quad (2:59)$$

where

f_w/F_w =ratio of the internal tension or compression stress, parallel to the face grain, to the allowable tension or compression stress in the same direction.

f_z/F_z =ratio of the internal tension or compression stress, perpendicular to the face grain, to the allowable tension or compression stress in the same direction.

f_{suw}/F_{suw} =ratio of the internal shear stress, parallel and perpendicular to the face grain, to the allowable shear stress in the same direction.

In the use of equation (2:59), it is necessary first to resolve the internal stresses into directions that are parallel and perpendicular to the face grain direction by use of the following transformation equations:

$$f_w = f_1 \cos^2 \theta + f_2 \sin^2 \theta - 2f_{s12} \sin \theta \cos \theta$$

$$f_z = f_1 \sin^2 \theta + f_2 \cos^2 \theta + 2f_{s12} \sin \theta \cos \theta$$

$$f_{suw} = (f_1 - f_2) \sin \theta \cos \theta + f_{s12} (\cos^2 \theta - \sin^2 \theta) \quad (2:60)$$

in which the symbols have the meanings indicated in figure 2-12 and θ is measured positively from the direction of the face grain to the direction of axis 1.

In order to clarify the use which can be made of the combined loading equation (2:59), the complete derivation of equation (2:53) is given. It is desired to find the allowable tensile stress of a plywood element which is loaded as shown in figure 2-23.

Thus in equation (2:60) $f_w = f_{tw}$, $f_z = f_{tz}$, $f_1 = f_t$ and $f_2 = f_{s12} = 0$; and the equations reduce to:

$$f_{tw} = f_t \cos^2 \theta$$

$$f_{tz} = f_t \sin^2 \theta$$

$$f_{suw} = f_t \sin \theta \cos \theta$$

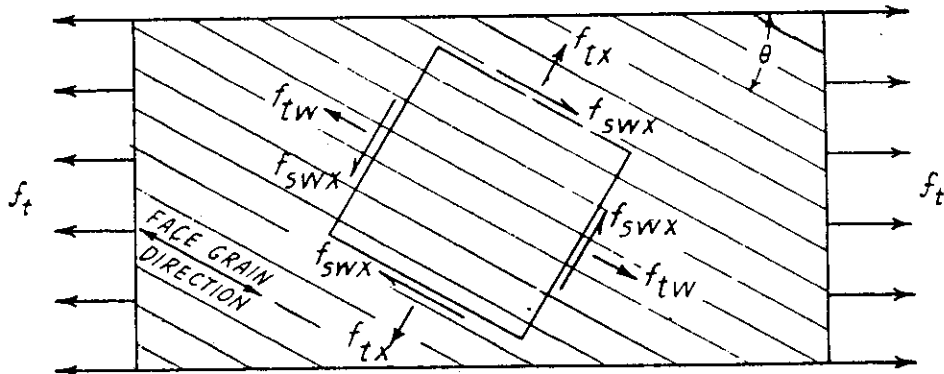

Figure 2-23. Orientation of plywood element for derivation of formula (2:53).

Substituting these terms in the combined loading equation

$$\left[\frac{f_{tw}}{F_{tw}} \right]^2 + \left[\frac{f_{tx}}{F_{tx}} \right]^2 + \left[\frac{f_{swx}}{F_{swx}} \right]^2 = 1$$

the following is obtained:

$$\left[\frac{f_t \cos^2 \theta}{F_{tw}} \right]^2 + \left[\frac{f_t \sin^2 \theta}{F_{tx}} \right]^2 + \left[\frac{f_t \sin \theta \cos \theta}{F_{swx}} \right]^2 = 1$$

Dividing through by f_t and setting its value equal to the allowable tensile stress, $F_{tw}\theta$, gives equation (2:53), or

$$F_{tw}\theta = \frac{1}{\sqrt{\left[\frac{\cos^2 \theta}{F_{tw}} \right]^2 + \left[\frac{\sin^2 \theta}{F_{tx}} \right]^2 + \left[\frac{\sin \theta \cos \theta}{F_{swx}} \right]^2}} \quad (2:53)$$

Equations (2:51), (2:55), and (2:56) may be derived in exactly the same manner.

Equation (2:38) is derived in a similar manner in which f_2 and f_{s12} are not equated to zero but are allowed to assume values which make f_1 a maximum. Equation (2:37) also may be derived in this manner.

These equations were taken from reference 2-67.

2.614. *Elements in bending.* The apparent moduli of elasticity (E_{fw} and E_{fx}) of plywood beams in bending are given by the general formulas in section 2.5. When all of the plies are of equal thickness and one species, these general formulas reduce to the following forms:

For rotary-cut veneer,

$$\text{three-ply; } E_{fw} = \frac{E_L}{27} \left(\frac{E_T}{E_L} + 26 \right) \quad (2:61)$$

$$E_{fx} = \frac{E_L}{27} \left(1 + 26 \frac{E_T}{E_L} \right)$$

$$\text{five-ply; } E_{fw} = \frac{E_L}{125} \left(26 \frac{E_T}{E_L} + 99 \right) \quad (2:62)$$

$$E_{fx} = \frac{E_L}{125} \left(26 + 99 \frac{E_T}{E_L} \right)$$

seven-ply;

$$E_{fw} = \frac{E_L}{343} \left(99 \frac{E_T}{E_L} + 244 \right)$$

$$E_{fx} = \frac{E_L}{343} \left(99 + 244 \frac{E_T}{E_L} \right) \quad (2:63)$$

nine-ply;

$$E_{fw} = \frac{E_L}{729} \left(244 \frac{E_T}{E_L} + 485 \right)$$

$$E_{fx} = \frac{E_L}{729} \left(244 + 485 \frac{E_T}{E_L} \right) \quad (2:64)$$

For quarter-sliced veneer, E_T/E_L should be replaced by E_R/E_L (sec. 2.13).

The bending stress in the extreme fiber of the outermost longitudinal ply is given by the following formulas:

Face grain parallel to span

$$f_b = 1.18 \frac{Mc'}{I} \frac{E_L}{E_{fw}} \quad (2:65)$$

Face grain perpendicular to span

$$f_b = 0.91 \frac{Mc'}{I} \frac{E_L}{E'_{fx}} \quad (\text{for 3-ply}) \quad (2:66)$$

$$f_b = 1.11 \frac{Mc'}{I} \frac{E_L}{E'_{fx}} \quad (\text{all other}) \quad (2:67)$$

where

c' = distance from neutral axis to extreme fiber of outermost longitudinal ply.

E'_{fx} = same as E_{fx} except that outermost ply in tension is neglected. E_{fx} may be used in place of E'_{fx} in formula (2:67) with only slight error.

E_L is taken for the species of the outermost longitudinal ply.

The allowable bending stress at proportional limit (F_{bp}) and the modulus of rupture in bending (F_{bu}) are given in tables 2-6 and 2-7. (Ref. 2-25)

2.6140. *Deflections.* The deflection of plywood beams with face grain parallel or perpendicular to the span may be obtained by using E_{fw} or E_{fx} in the ordinary beam formulas. E'_{fx} is used only for determining strengths in bending and not the deflection. For plywood beams with face grain at an angle θ to the direction of the span, the effective modulus of elasticity to be used in the deflection formula is given by the equation:

$$E = \frac{1}{\lambda_f} [E_{fx} \cos^4 \theta + E_{fw} \sin^4 \theta + (2E_{fx}\mu_{fxw} + 4\lambda_f G_{fxw}) \sin^2 \theta \cos^2 \theta] \quad (2:68)$$

in which $\lambda_f = 1 - \mu_{fxw}\mu_{fwx}$
when

- (1) The loading is constant across the width of the beam at any point in its span.
- (2) The beam width is sufficient to cause the deflection to be constant across the beam at any point in the span.
- (3) The beam is held so that it cannot leave the supports.

There are no methods available by which the strength of plywood beams may be calculated

when the grain direction of the face plies is other than parallel or perpendicular to the span.

2.615. *Elements as columns.* The allowable stresses for plywood columns are given by the following formulas:

Long columns

$$F_c = \frac{0.85\pi^2 E_{fw}}{(L'/\rho)^2} \quad (\text{face grain parallel to length}) \quad (2:69)$$

$$F_c = \frac{0.85\pi^2 E_{fx}}{(L'/\rho)^2} \quad (\text{face grain perpendicular to length}) \quad (2:70)$$

$$(L'/\rho)_{cr} = 3.55 \sqrt{\frac{E_{fw}}{F_{cuw}}}$$

$$\text{or } 3.55 \sqrt{\frac{E_{fx}}{F_{cux}}} \text{ respectively}$$

Short columns

$$F_c = F_{cu} \left[1 - \frac{1}{3} \left(\frac{L'}{K\rho} \right)^4 \right] \quad (2:71)$$

where

$$K = (L'/\rho)_{cr}$$

$$F_{cu} = F_{cuw} \text{ when face grain is parallel to length}$$

$$= F_{cux} \text{ when face grain is perpendicular to length}$$

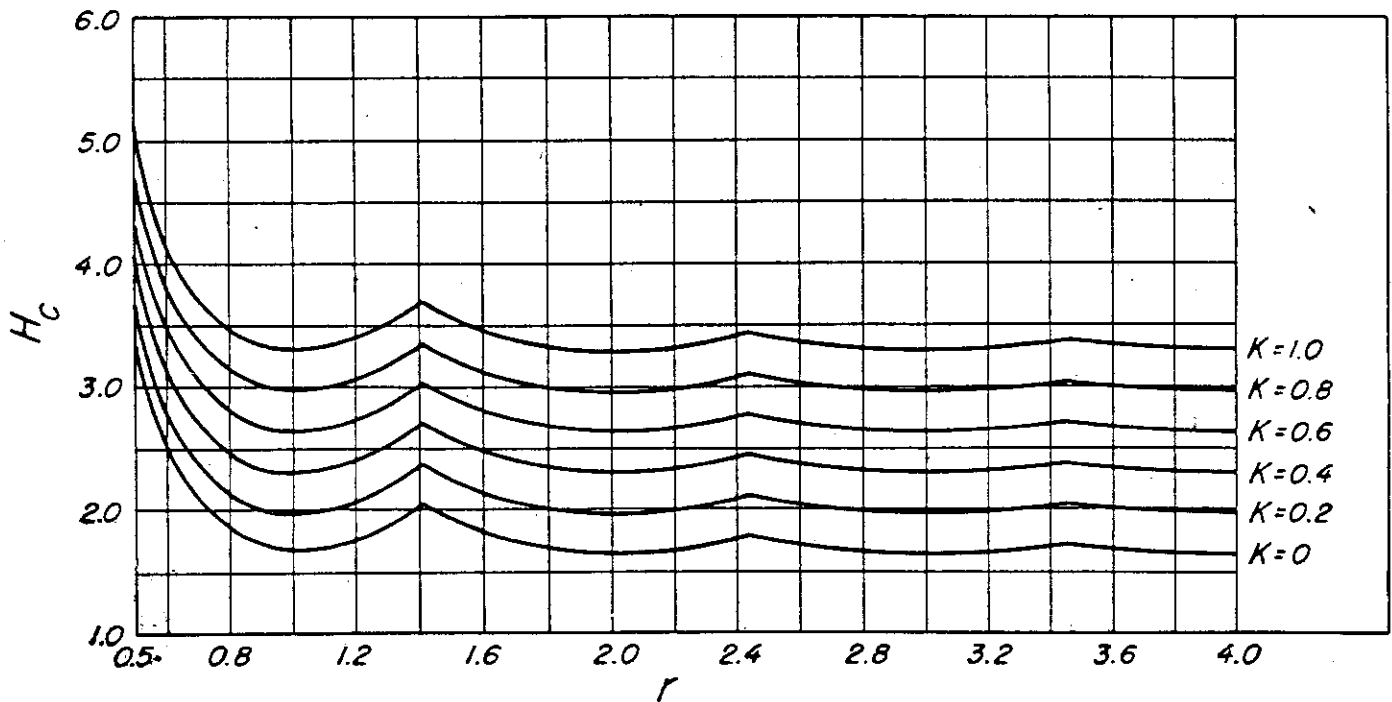

Figure 2-25. Plot of equation (2:74).

2.7. Flat Rectangular Plywood Panels

2.71. BUCKLING CRITERIA.

2.711. *General.* When buckling occurs in plywood panels at loads less than the required design loads, the resulting redistribution of stresses must be considered in the analysis of the structure. The buckling criteria in this section are based on mathematical analyses and are confirmed by experiments for stresses below the proportional limit. Visible buckling may occur at lower stresses than those indicated by these criteria, due to the imperfections and eccentric loadings which usually exist in structures. Experiments have indicated, however, that the redistribution of stresses due to buckling corresponds more closely to the degree of buckling indicated by these theoretical criteria than it does to visible buckling. These criteria can, therefore, be used in various parameters for plotting test results or design allowables against the degree of buckling, and to compute the degree of buckling in a structure. This is done in sections 2.72 and 2.760.

Since the mathematical analyses are based on the assumption of elastic behavior, these criteria cannot be directly applied when the stresses are above proportional limit. The behavior at such stresses has been investigated experimentally for some cases, as described in sections 2.72 and 2.760. Because of the low modulus of elasticity of wood across the grain it is difficult to approach clamped-edge conditions.

2.712. *Compression* ($\beta=0^\circ$ or 90°). The critical buckling stress of flat rectangular plywood panels subjected to uniform compressive stress is given by the following formula (ref. 2-55).

$$F_{cer} = H_c \frac{\sqrt{E_{fx} E_{fy}}}{\lambda_f} \left(\frac{t}{a}\right)^2 \quad (2:72)$$

in which H_c depends upon the edge conditions of the panel and other considerations in the following cases.

Case I. All edges simply supported.

$$H_c = \frac{\pi^2}{12} \left[\left(\frac{r}{m}\right)^2 + \left(\frac{m}{r}\right)^2 + 2k \right] \quad (2:73)$$

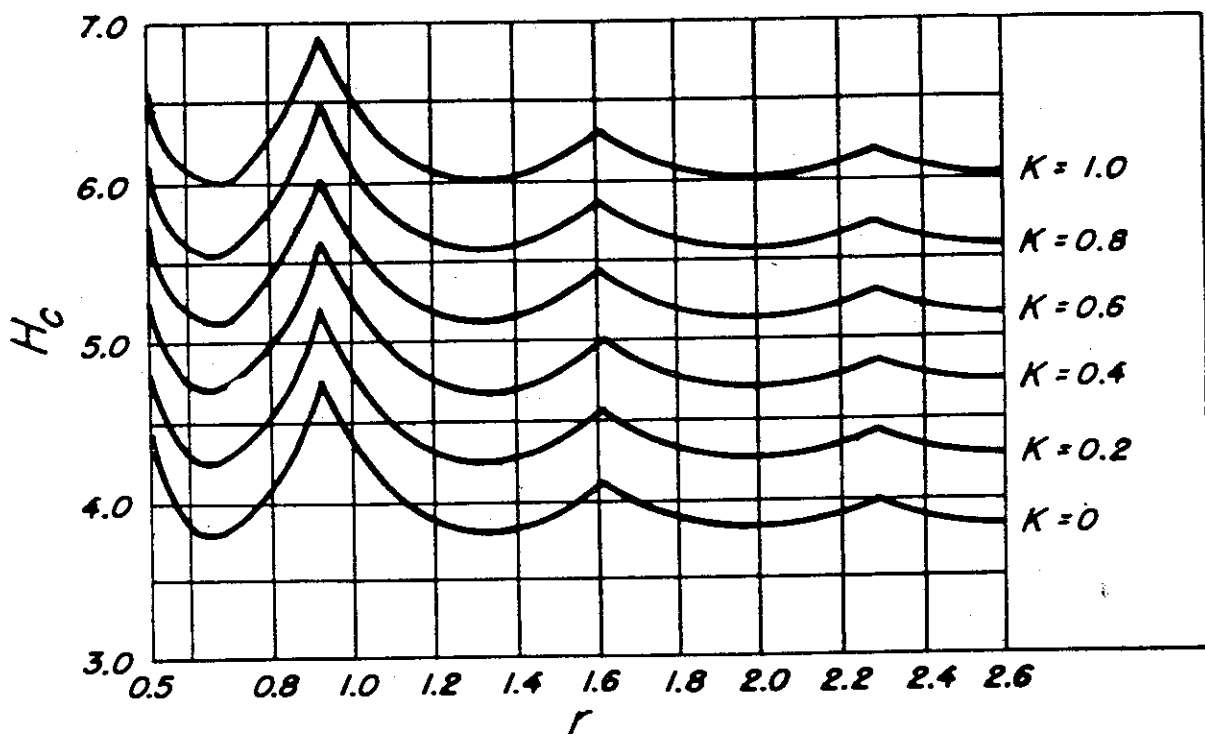

Figure 2-24. Plot of equation (2:73)

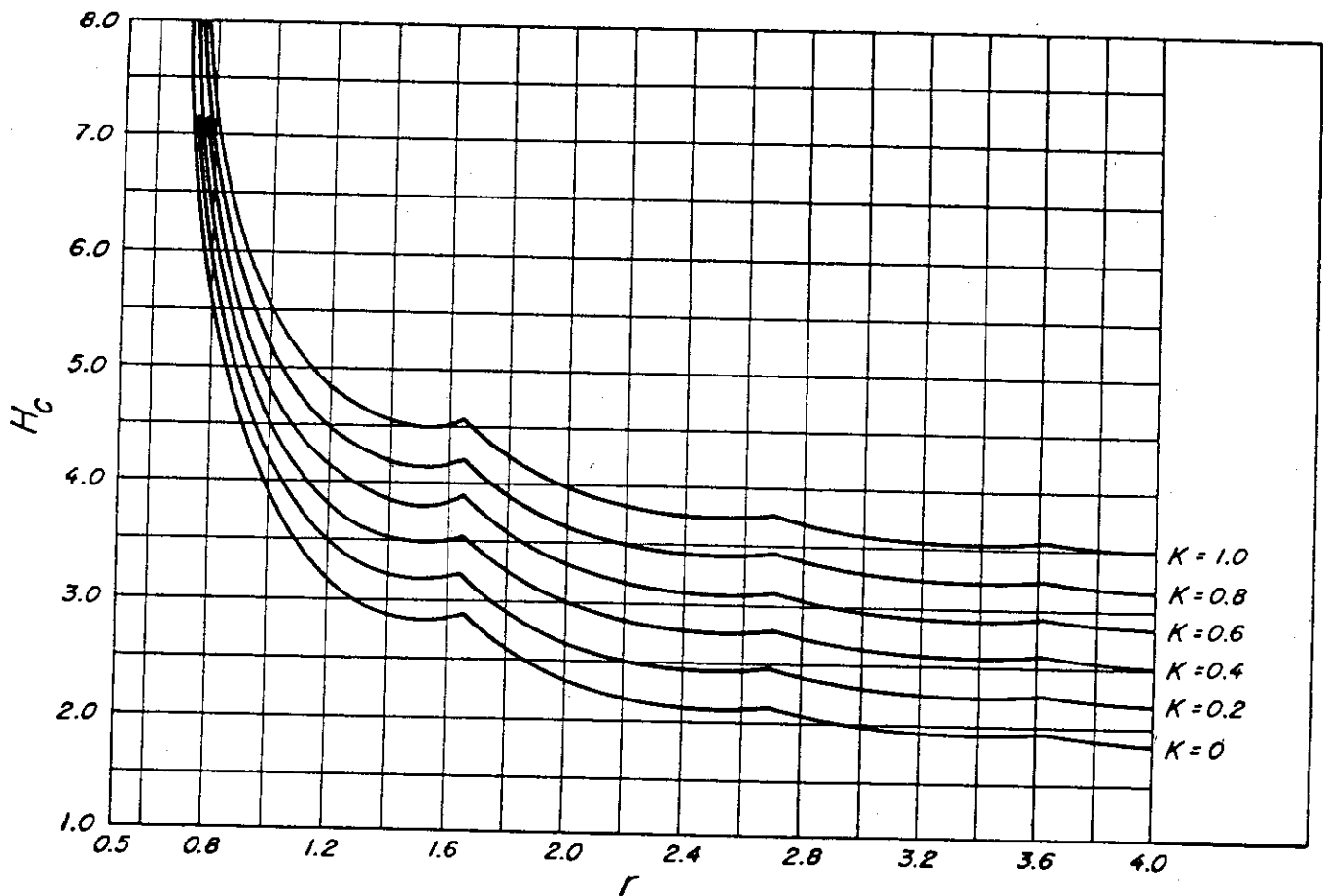

Figure 2-26. Plot of equation (2:75).

in which

$$k = \frac{E_{fzu} \mu_{fzv} + 2\lambda_f G_{fuz}}{\sqrt{E_{fzu} E_{fz}}}$$

$$r = \frac{b}{a} \left(\frac{E_1}{E_2} \right)^{1/4}$$

m = the number of half-wave lengths in the shape of the buckled panel defined by the inequality,

$$\sqrt{m(m-1)} < r < \sqrt{m(m+1)}$$

Case II. Loaded edges simply supported. Remaining edges clamped.

$$H_c = \frac{4\pi^2}{9} \left[\left(\frac{r}{m} \right)^2 + \frac{3}{16} \left(\frac{m}{r} \right)^2 + \frac{k}{2} \right] \quad (2:74)$$

$$\frac{1}{2} \sqrt{m(m-1)} \sqrt{3} < r < \frac{1}{2} \sqrt{m(m+1)} \sqrt{3}$$

Case III. Two loaded edges clamped. Remaining edges simply supported.

For one half-wave

$$H_c = \frac{\pi^2}{48} \left(3r^2 + \frac{16}{r^2} + 8k \right)$$

For two half-waves

$$H_c = \frac{\pi^2}{60} \left(r^2 + \frac{41}{r^2} + 10k \right)$$

For three half-waves

$$H_c = \frac{\pi^2}{120} \left(r^2 + \frac{136}{r^2} + 20k \right)$$

For four half-waves

$$H_c = \frac{\pi^2}{204} \left(r^2 + \frac{353}{r^2} + 34k \right)$$

The value of H_c that is least for the particular panel involved, should be used.

Case IV. All edges clamped.

For one half-wave

$$H_c = \frac{\pi^2}{9} \left(3r^2 + \frac{3}{r^2} + 2k \right)$$

For two half-waves

$$H_c = \frac{\pi^2}{180} \left(16r^2 + \frac{123}{r^2} + 40k \right)$$

For three half-waves

$$H_c = \frac{\pi^2}{45} \left(2r^2 + \frac{51}{r^2} + 10k \right)$$

For four half-waves

$$H_c = \frac{\pi^2}{612} \left(16r^2 + \frac{1059}{r^2} + 136k \right) \quad (2:76)$$

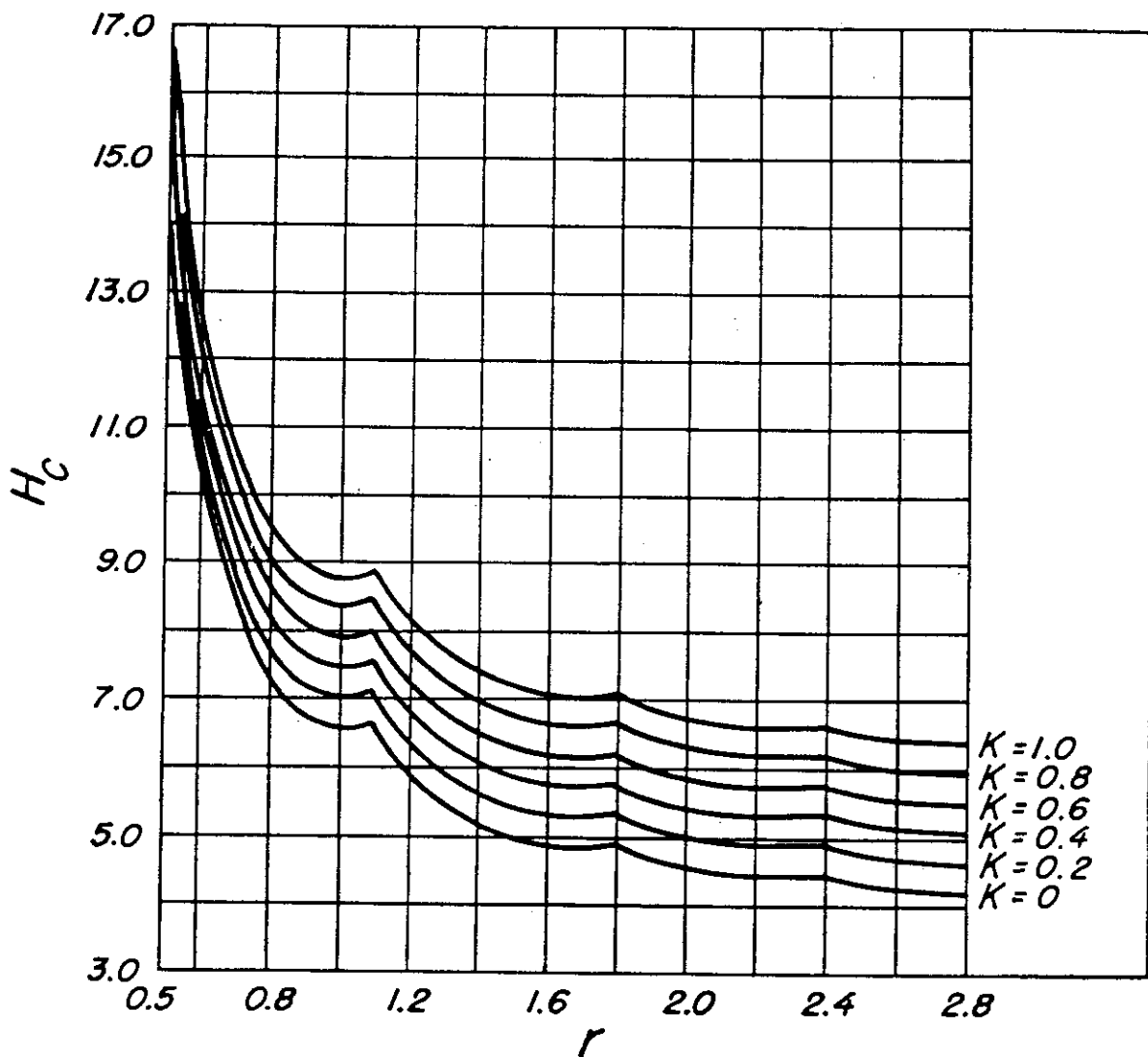

Figure 2-27. Plot of equation (2:76).

The value of H_c that is least for the particular panel involved, should be used.

2.713. *Shear* ($\beta=0^\circ$ or 90°). The critical buckling stress of flat rectangular plywood panels subjected to uniform shear stress is given by the following formula (ref. 2-50).

$$F_{scr} = H_s \frac{(E_1^3 E_2)^{1/4}}{3\lambda_f} \left(\frac{t}{a}\right)^2 \quad (2:77)$$

in which values of H_s are obtained from figure 2-28 for panels having simply supported edges and from figure 2-29 for clamped edges. The symbols a and b are assigned to the dimensions of the panel

in such a way that $\frac{1}{r} = \frac{a}{b} \left(\frac{E_2}{E_1}\right)^{1/4}$ is less than or equal to unity.

2.714. *Combined compression and shear* ($\beta=0^\circ$ or 90°). The critical buckling stresses of flat rectangular panels subjected to combined compression and shear may be obtained by use of the fol-

lowing interaction formula (ref. 2-50)

$$\left(\frac{f_{scr}}{F_{scr}}\right)^2 + \frac{f_{ccr}}{F_{ccr}} = 1 \quad (2:78)$$

in which the ratio of f_{scr} to f_{ccr} is given by the particular problem to be solved. This equation is accurate only for isotropic plates, but is not greatly in error for plywood if $\beta=0^\circ$ or 90° .

2.715. *Compression, shear, and combined compression and shear* ($\beta=\text{any angle}$). When the direction of the face grain of the plywood makes an angle other than 0° or 90° with the edge of the plywood, accurate methods of calculation are extremely complicated, and, therefore, an approximate method is resorted to. The curves of figures 2-30 to 2-41, inclusive, apply accurately only to Douglas-fir plywood, but their use is extended approximately to other species by the method described. Curves for the cases in which $\beta=0^\circ$ or 90° are included for the sake of completeness.

By this method the critical buckling stress of flat rectangular plywood panels subjected to either uniform compression or uniform shear stresses is given by the following general formulas.

$$F_{scr} = K_c [E_{fw} + E_{fz}] \left(\frac{t}{a}\right)^2 \quad (2:79)$$

$$F_{scr} = K_s [E_{fw} + E_{fz}] \left(\frac{t}{a}\right)^2 \quad (2:80)$$

where

K_c and K_s are factors depending on the type of loading, the dimensions of the panel, the edge-fixity conditions, and Poisson's ratio. K_c and K_s are determined by the following methods.

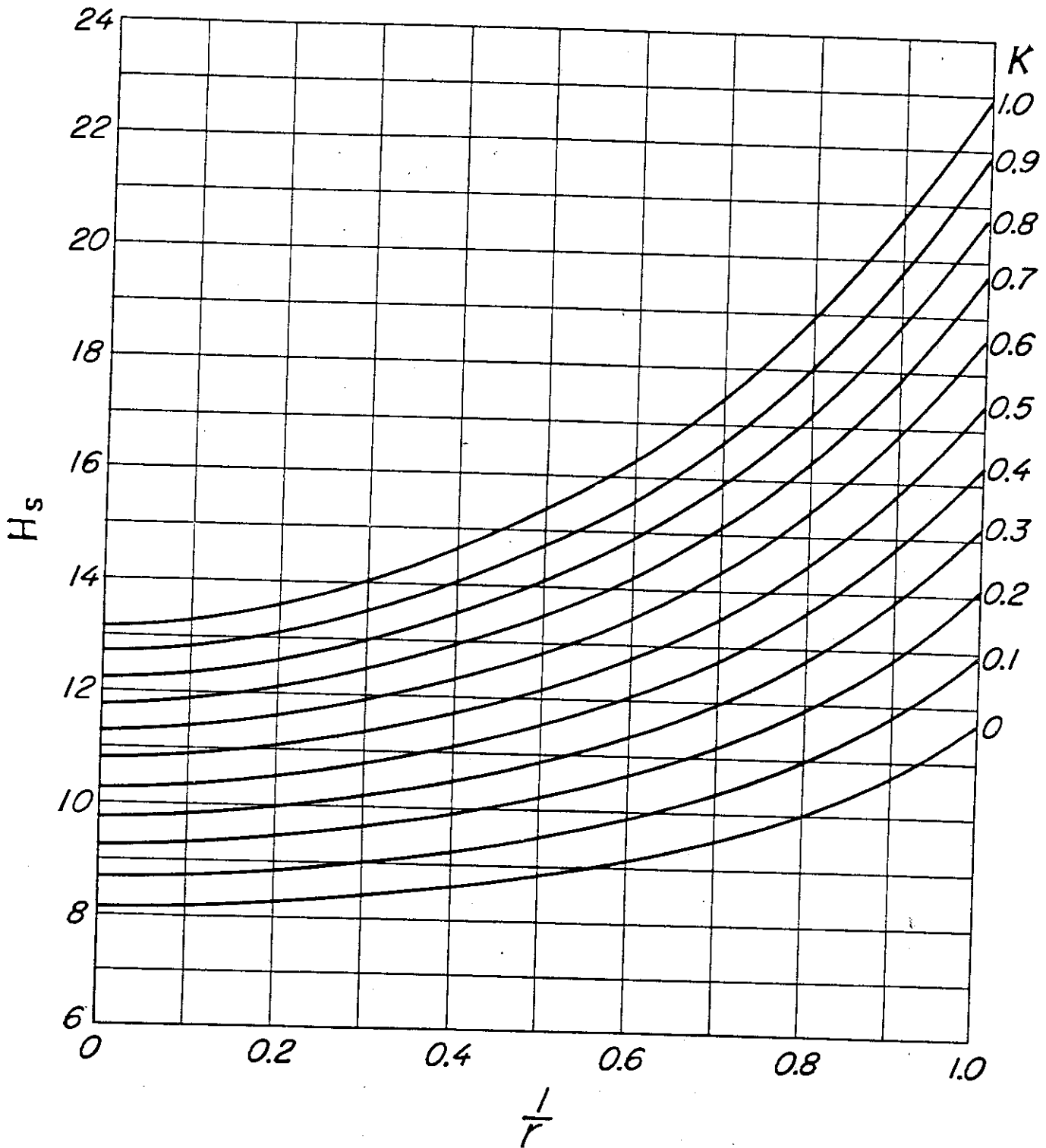

Figure 2-28. Curves for calculating the buckling shear stress in orthotropic rectangular plates, with simply supported edges whose axes of elastic symmetry are parallel to the edges. (Taken from paper by E. Seydel, *Zeitschrift für Flugtechnik und Luftschiffahrt* 24, 78-83, 1933.)

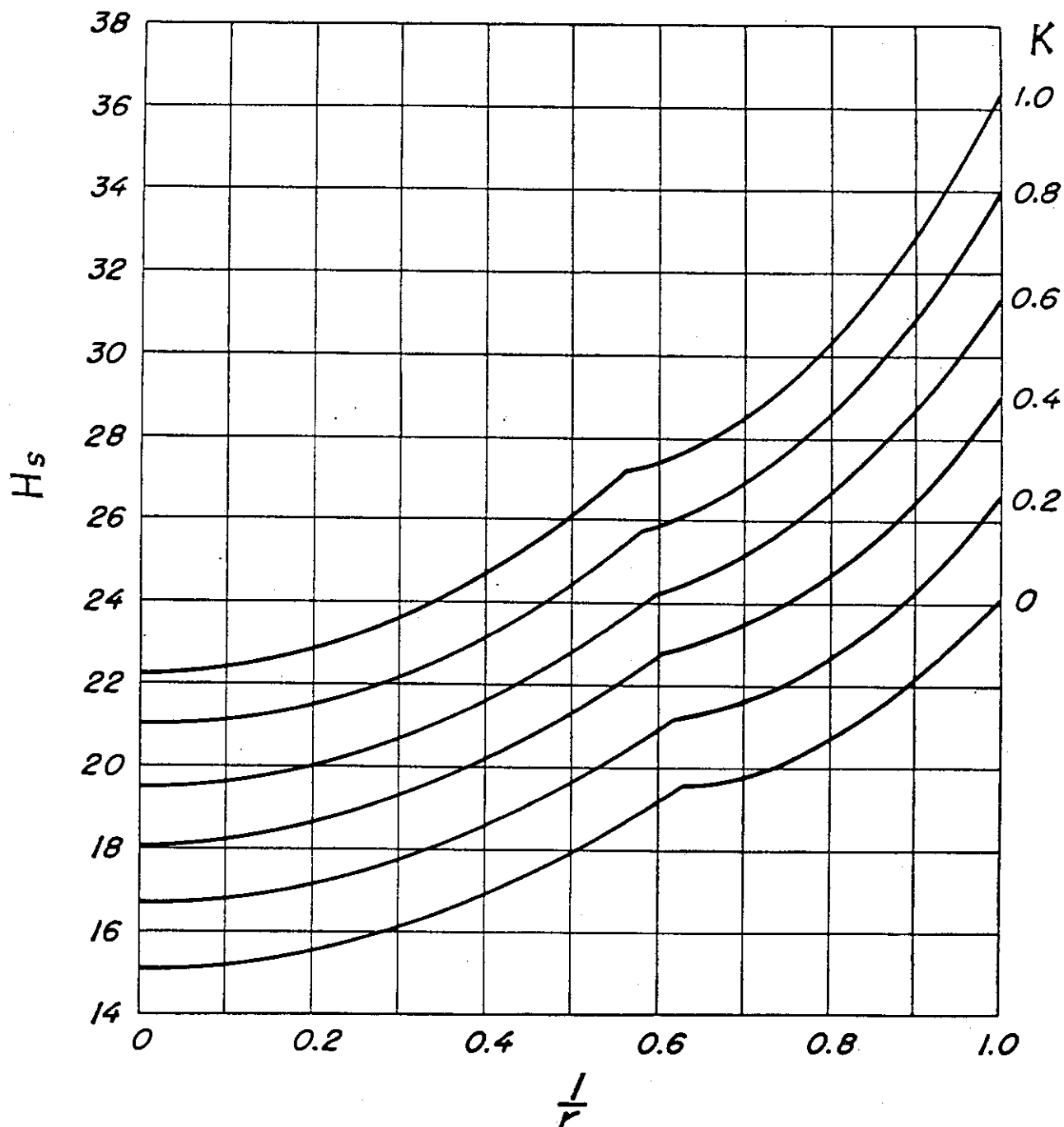

Figure 2-29. Curves for calculating the buckling shear stress in orthotropic rectangular plates, with clamped edges, whose axes of elastic symmetry are parallel to the edges. (Taken from report by R. C. T. Smith "The Buckling of Plywood Plates in Shear," Report SM. 51 of the Council for Scientific and Industrial Research, Division of Aeronautics Commonwealth of Australia.)

Let a be the width of a rectangular panel of infinite length of which a portion of finite length b is being considered.

The mathematical treatment of buckling constants presented in this section has been based on the assumption that the compression load is always placed on the edge having dimension a . In a panel loaded only in shear a dimension of either edge may be taken as a , and the panel

shall be considered as a $\beta=0^\circ$ case when the face grain is perpendicular to the edge having dimension a and as a $\beta=90^\circ$ case when the face grain is parallel to the edge having dimension a (fig. 2-42).

One method of obtaining K_s or K_c is by the use of figures 2-30 to 2-36 as explained in section 2.7151. Approximate values of K_s or K_c suitable for ordinary purposes may be obtained by cor-

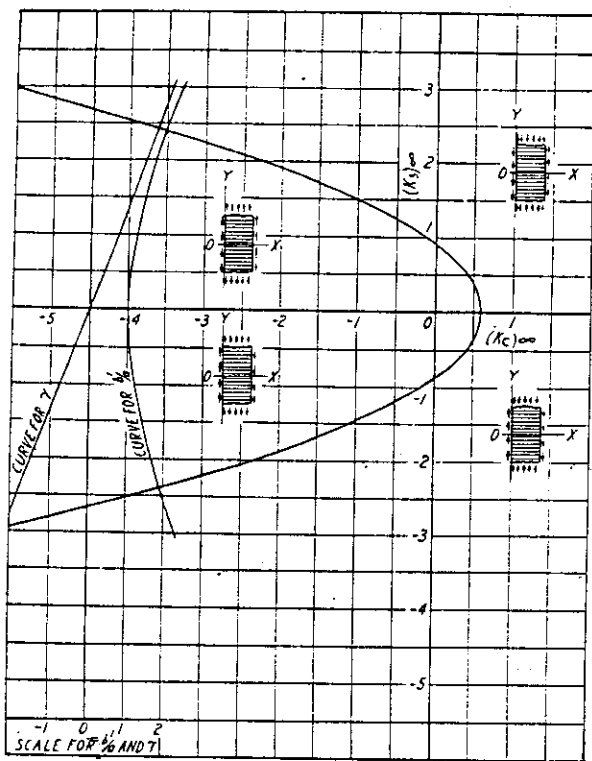

(a)
2-PLY (1:1) $\beta = 0^\circ$ AND $\beta = 90^\circ$

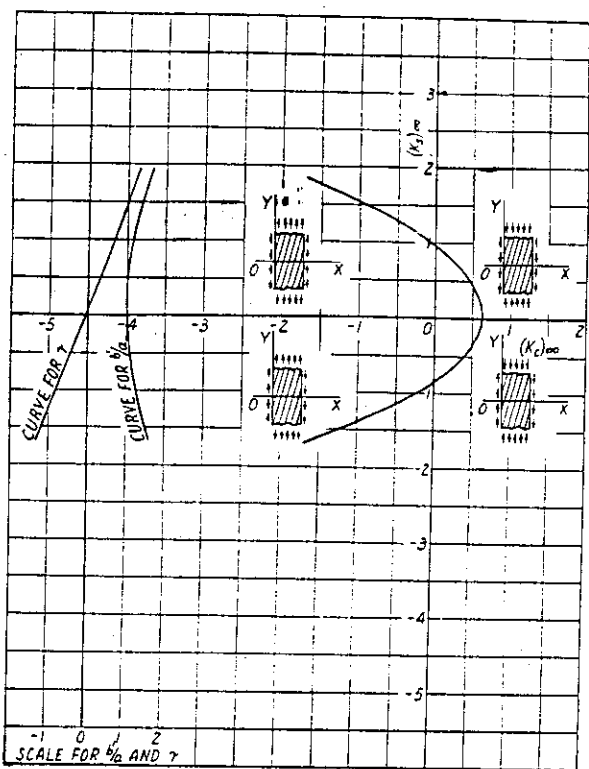

(b)
2-PLY (1:1) $\beta = 15^\circ$

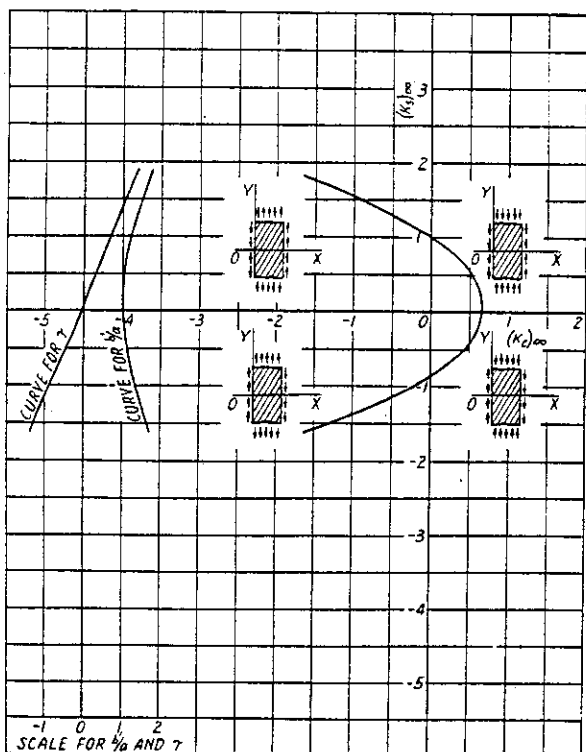

(c)
2-PLY (1:1) $\beta = 30^\circ$

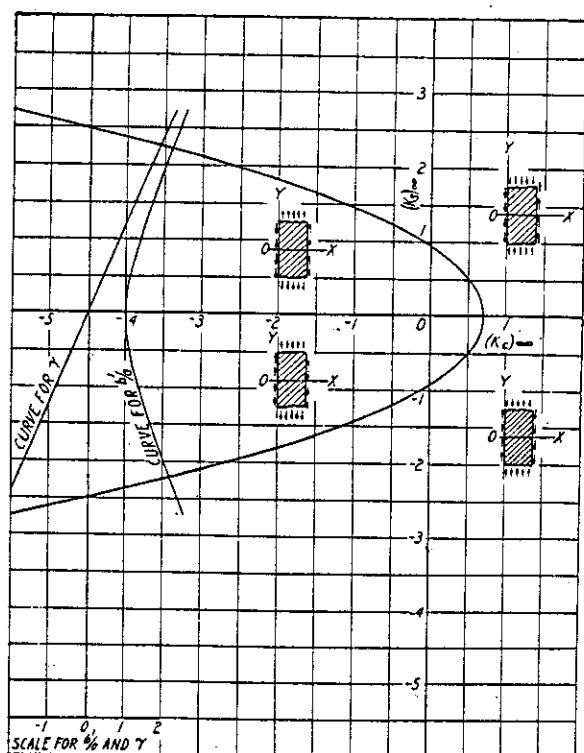

(d)
2-PLY (1:1) $\beta = 45^\circ$

Figure 2-80 (a, b, c, d). Curves of critical buckling constants for infinitely long rectangular plywood panels under combined loading. Edges simply supported. $\beta =$ angle between face grain and direction of applied stress. Two-ply construction.

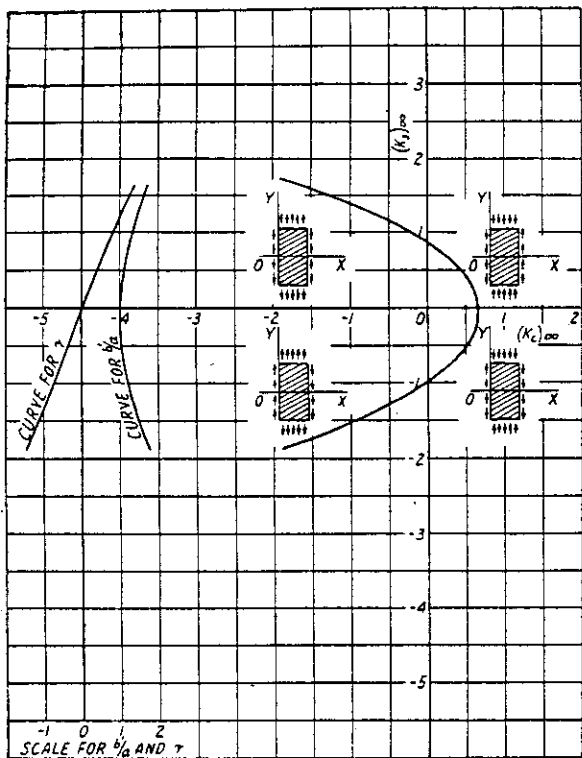

(e)
2-PLY (1:1) $\beta = 60^\circ$

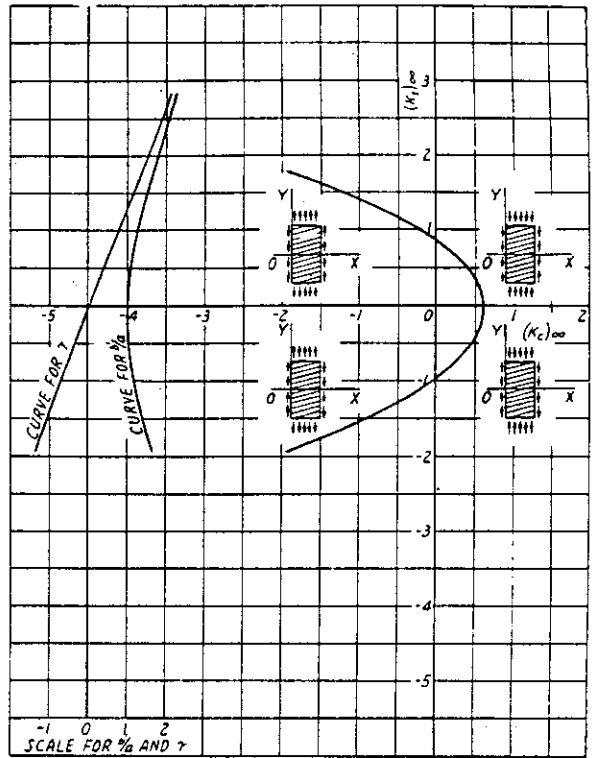

(f)
2-PLY (1:1) $\beta = 75^\circ$

Figure 2-30 (e, f)—Continued.

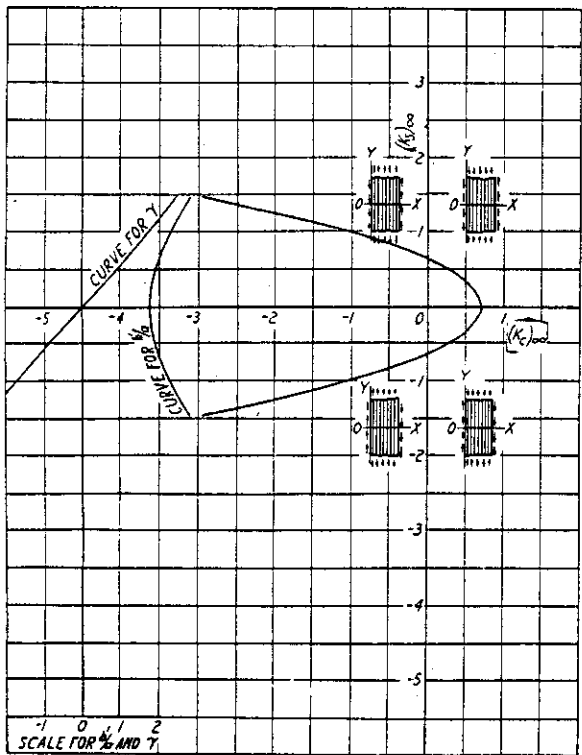

(a)
3-PLY (1:1:1) $\beta = 0^\circ$

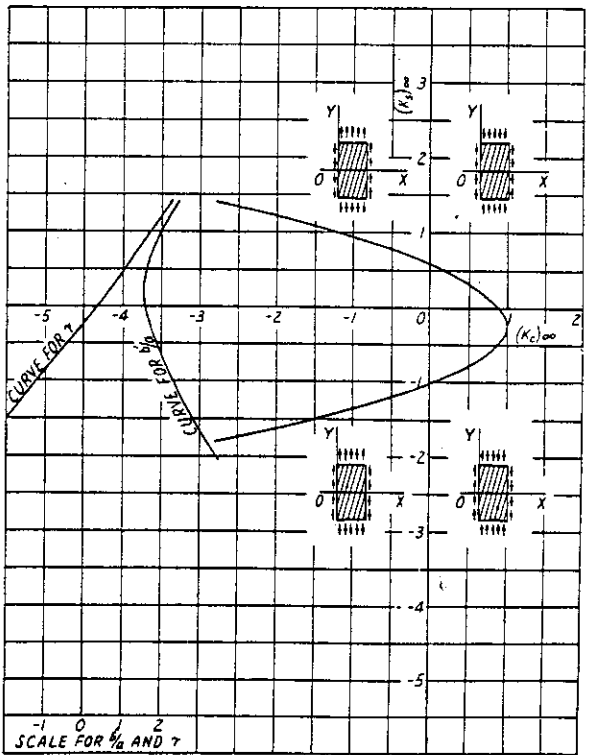

(b)
3-PLY (1:1:1) $\beta = 15^\circ$

Figure 2-31 (a, b). Curves of critical buckling constants for infinitely long rectangular plywood panels under combined loading. Edges simply supported. β = angle between face grain and direction of applied stress. Three-ply construction.

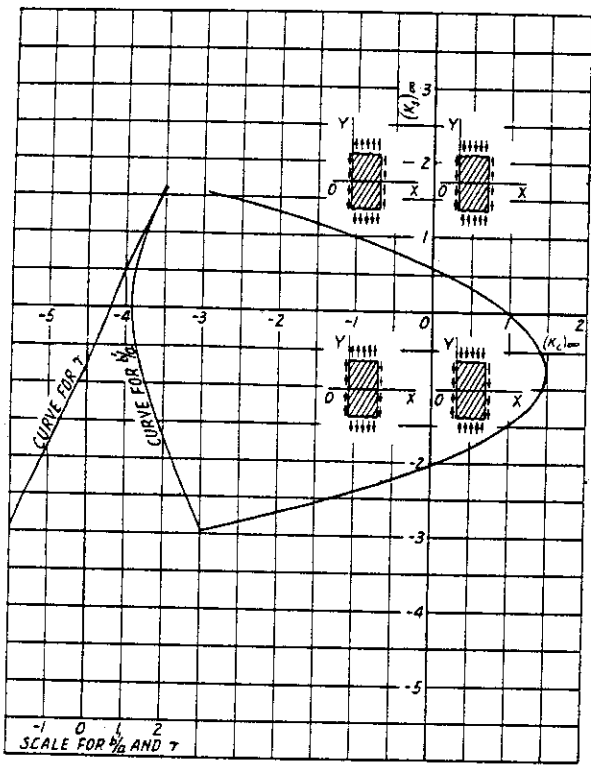

(c)
3-PLY (1:1:1) $\beta = 30^\circ$

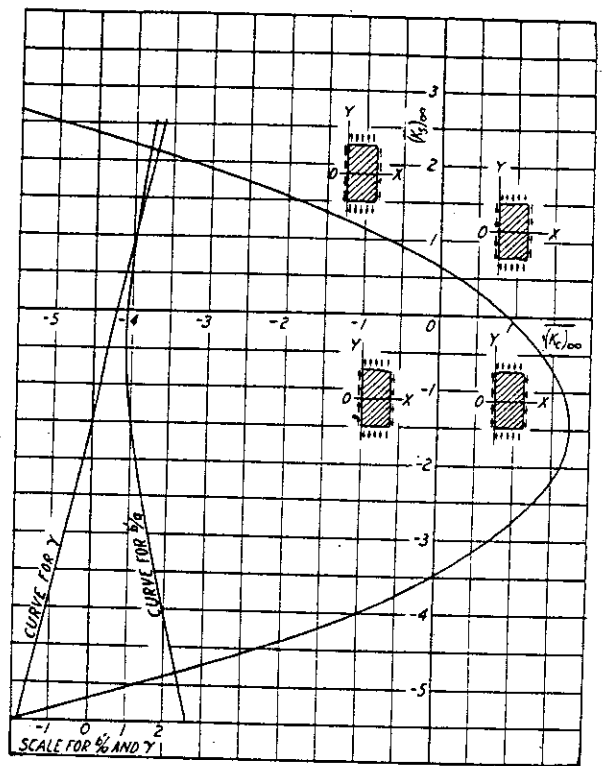

(d)
3-PLY (1:1:1) $\beta = 45^\circ$

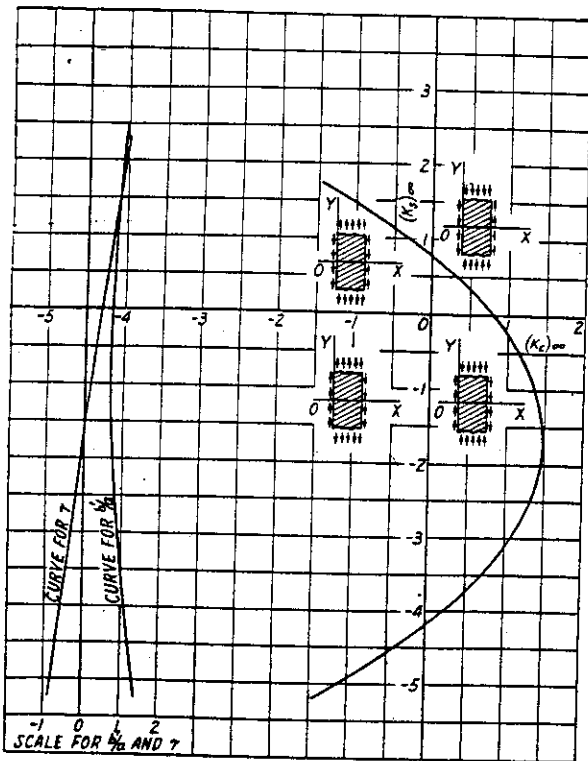

(e)
3-PLY (1:1:1) $\beta = 60^\circ$

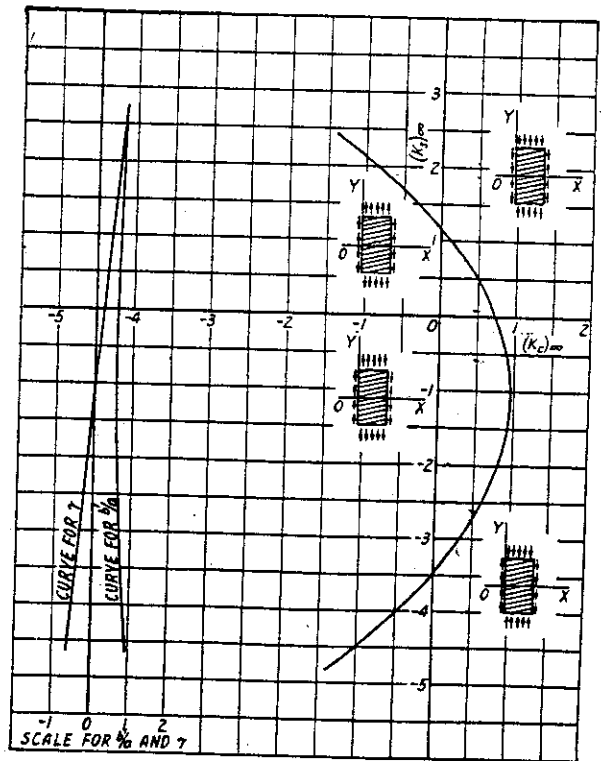

(f)
3-PLY (1:1:1) $\beta = 75^\circ$

Figure 2-31 (c, d, e, f)—Continued.

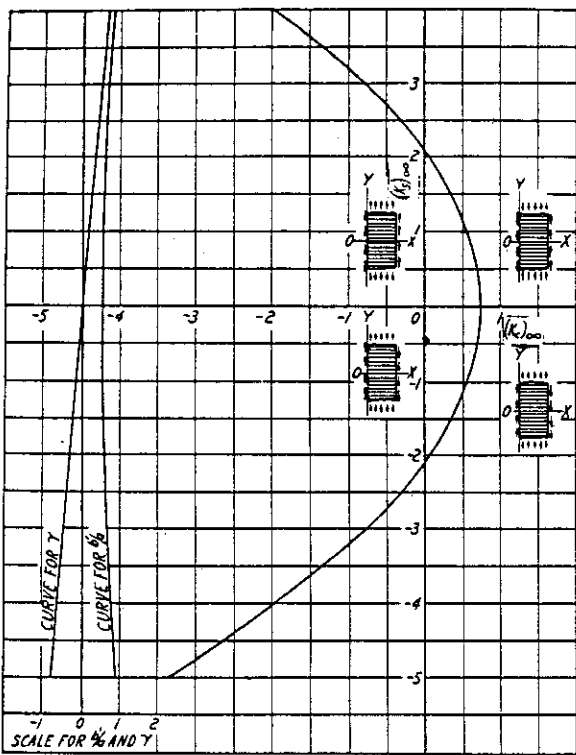

(g)
3-PLY (1:1:1) $\beta = 90^\circ$

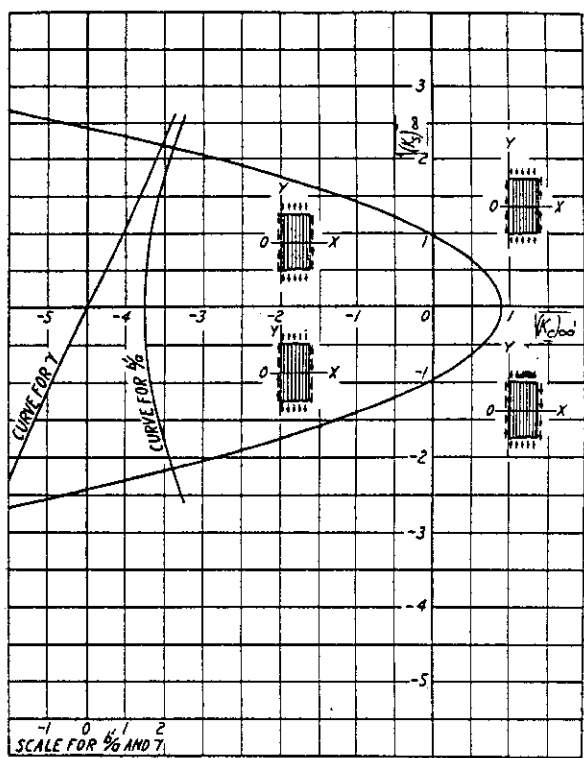

(h)
3-PLY (1:2:1) $\beta = 0^\circ$

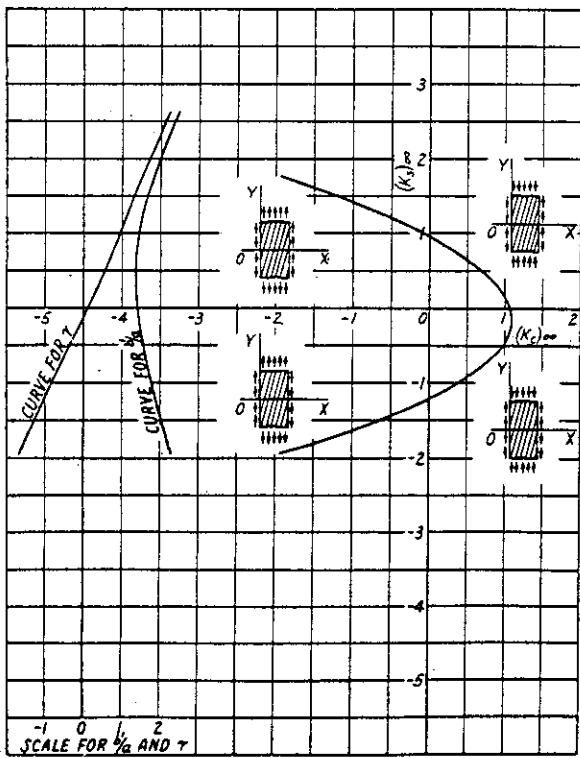

(i)
2 M 50604 F 3-PLY (1:2:1) $\beta = 15^\circ$

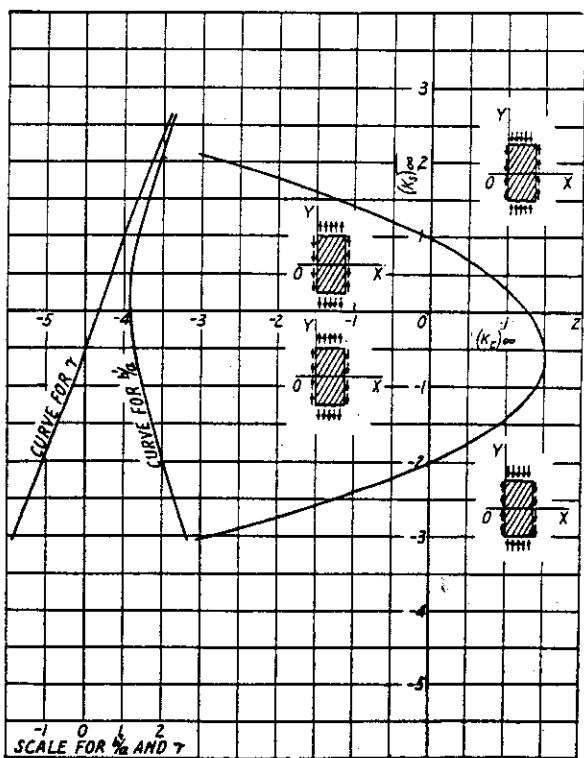

(j)
3-PLY (1:2:1) $\beta = 30^\circ$

Figure 2-31 (g, h, i, j)—Continued.

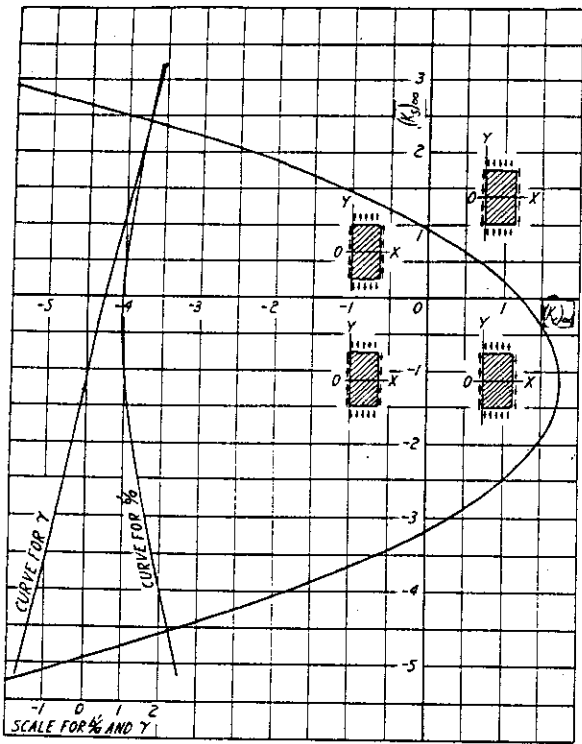

(k)
3-PLY (1:2:1) $B=45^\circ$

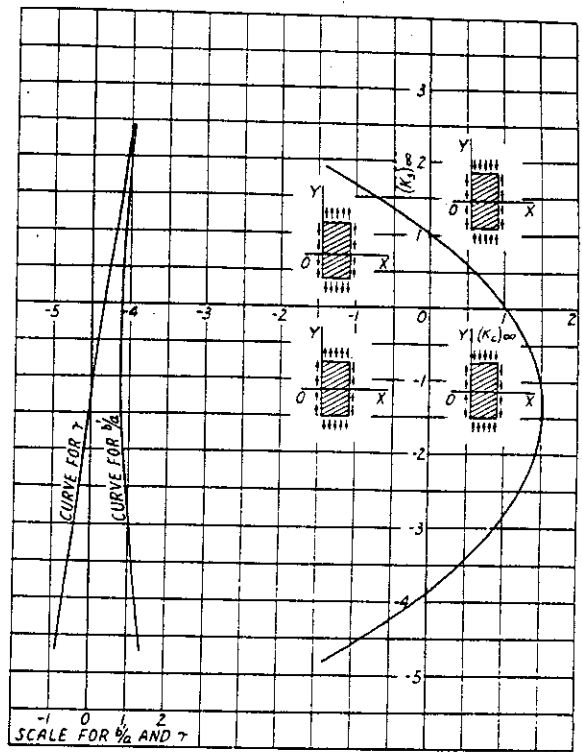

(m)
3-PLY (1:2:1) $B=60^\circ$

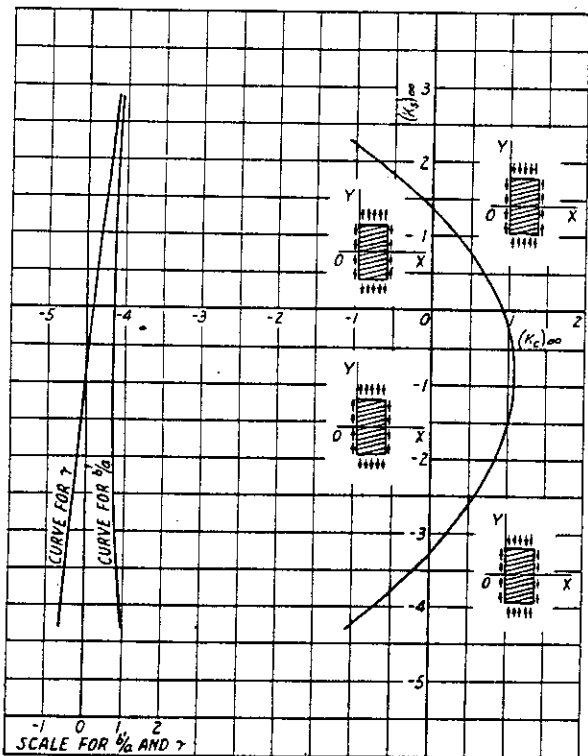

(n)
3-PLY (1:2:1) $B=75^\circ$

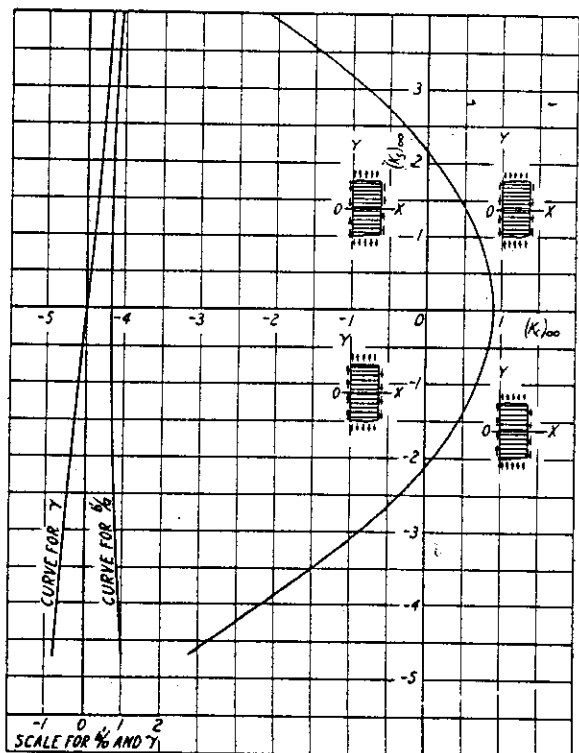

(p)
3-PLY (1:2:1) $B=90^\circ$

Figure 2-31 (k, m, n, p)—Continued.

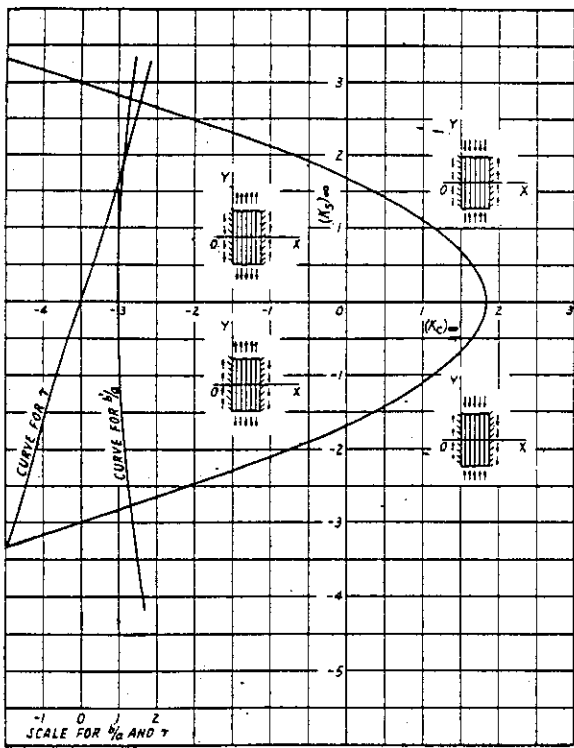

(a)
3-PLY (1:2:1) $\beta = 0^\circ$

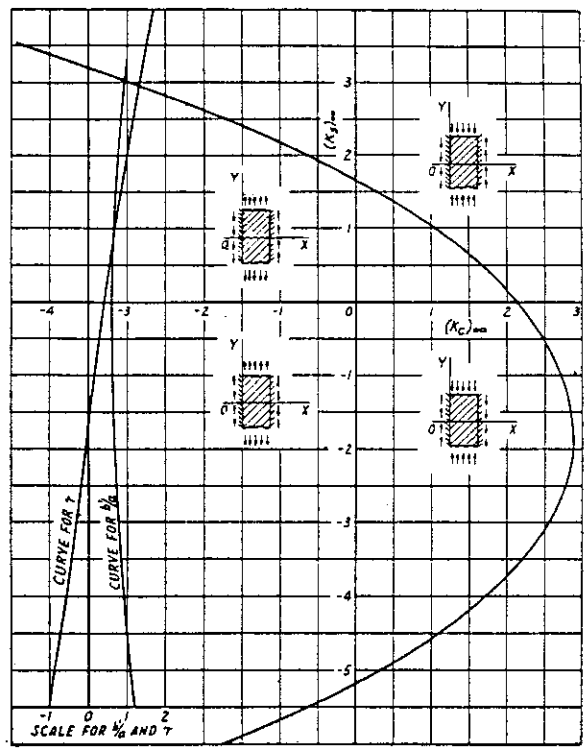

(b)
3-PLY (1:2:1) $\beta = 45^\circ$

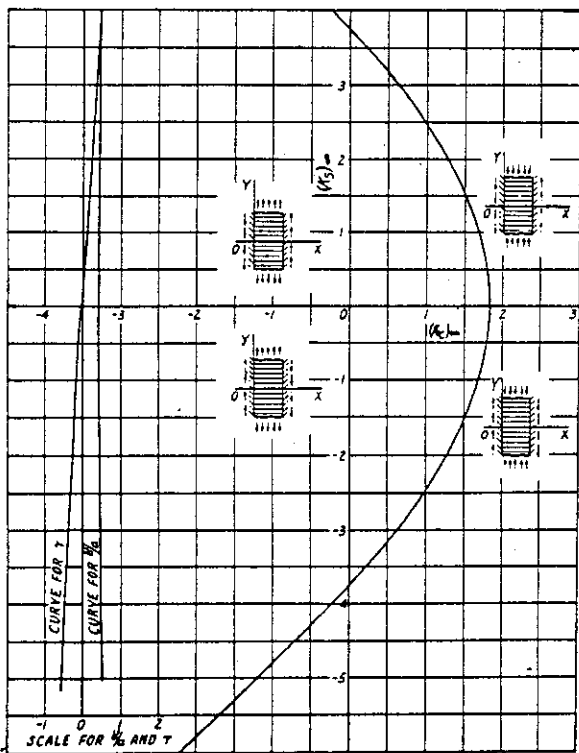

(c)
FIG. 37
3-PLY (1:2:1) $\beta = 90^\circ$

Figure 2-32 (a, b, c). Curves of critical buckling constants for infinitely long rectangular plywood panels under combined loading with edges clamped. β = angle between face grain and direction of applied stress. Three-ply construction.

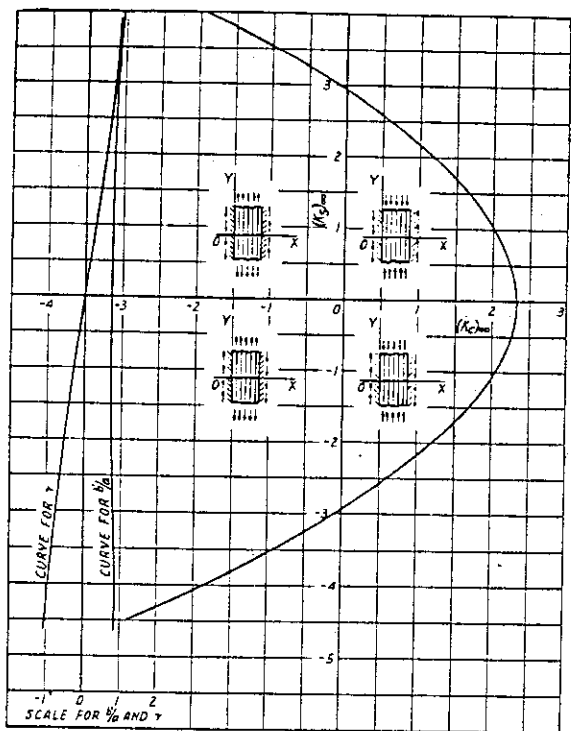

(d)
5-PLY (1:2:2:2:1) $\beta = 0^\circ$

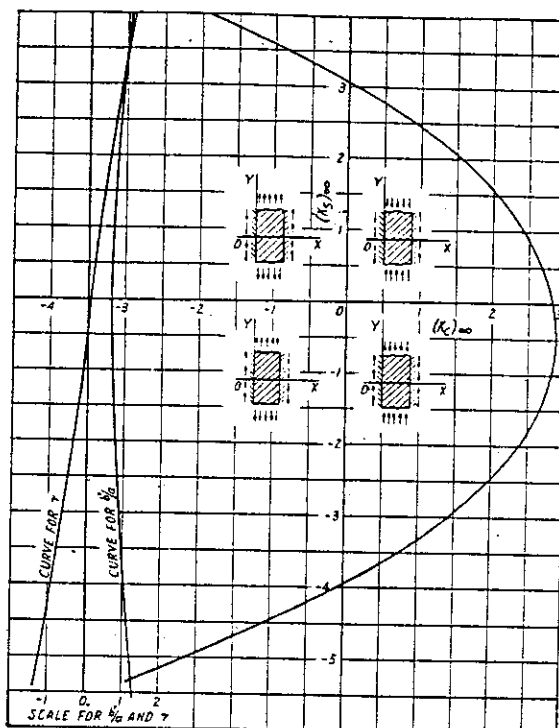

(e)
6-PLY (1:2:2:2:1) $\beta = 45^\circ$

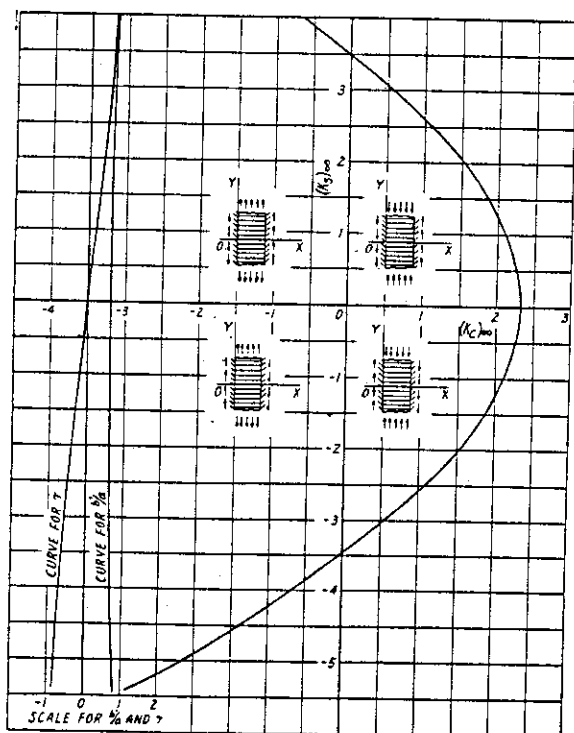

(f)
5-PLY (1:2:2:2:1) $\beta = 90^\circ$

Figure 2-33 (d, e, f). Curves of critical buckling constants for infinitely long rectangular plywood panels under combined loading with edges clamped. β = angle between face grain and direction of applied stress. Five-ply construction.

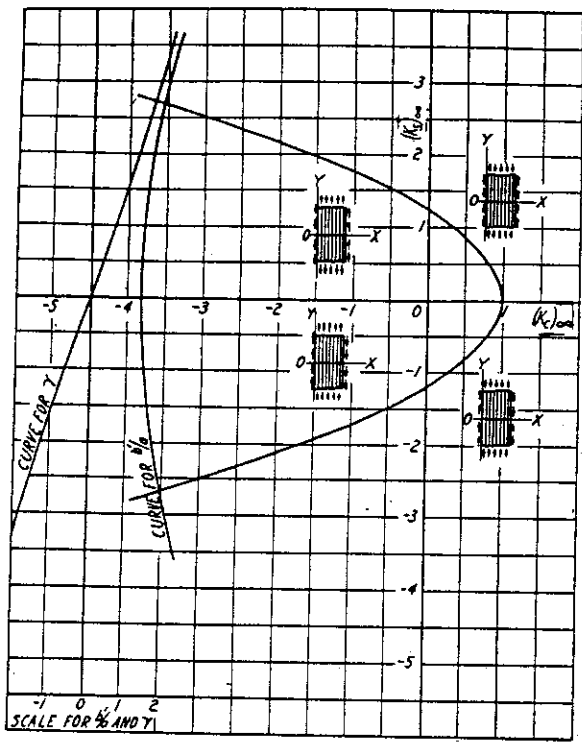

(a)
3-PLY (1:1:1) $\beta=0^\circ$

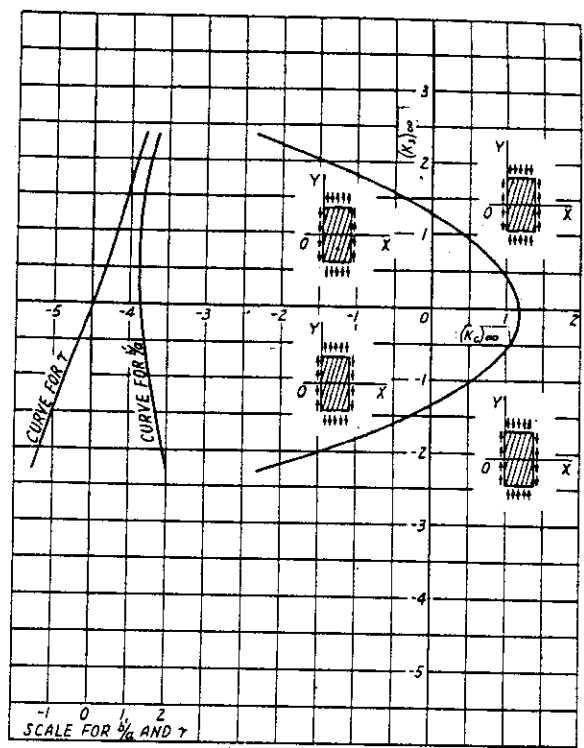

(b)
5-PLY (1:1:1:1:1) $\beta=15^\circ$

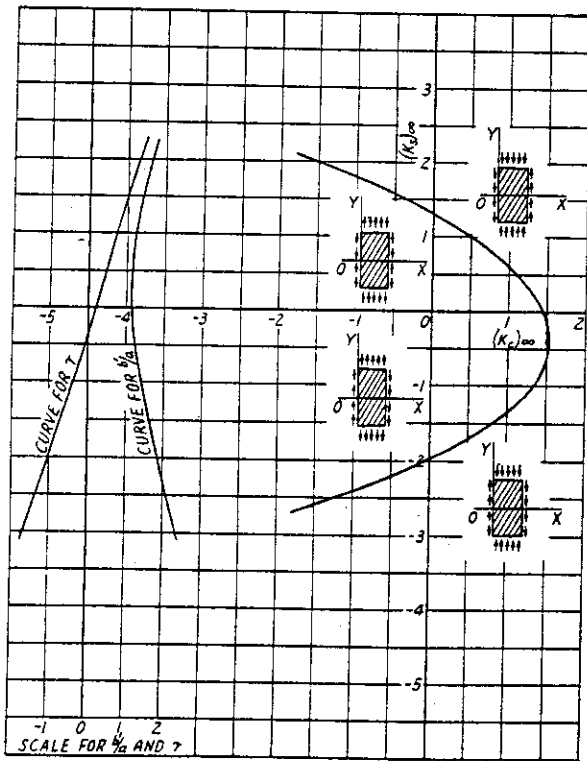

(c)
5-PLY (1:1:1:1:1) $\beta=30^\circ$

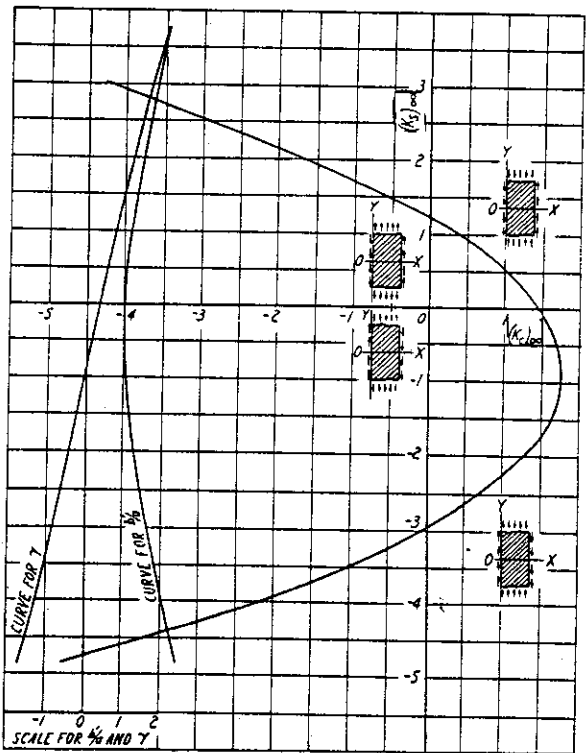

(d)
5-PLY (1:1:1:1:1) $\beta=45^\circ$

Figure 2-34 (a, b, c, d). Curves of critical buckling constants for infinitely long rectangular plywood panels under combined loading. Edges simply supported. β = angle between face grain and direction of applied stress. Five-ply construction.

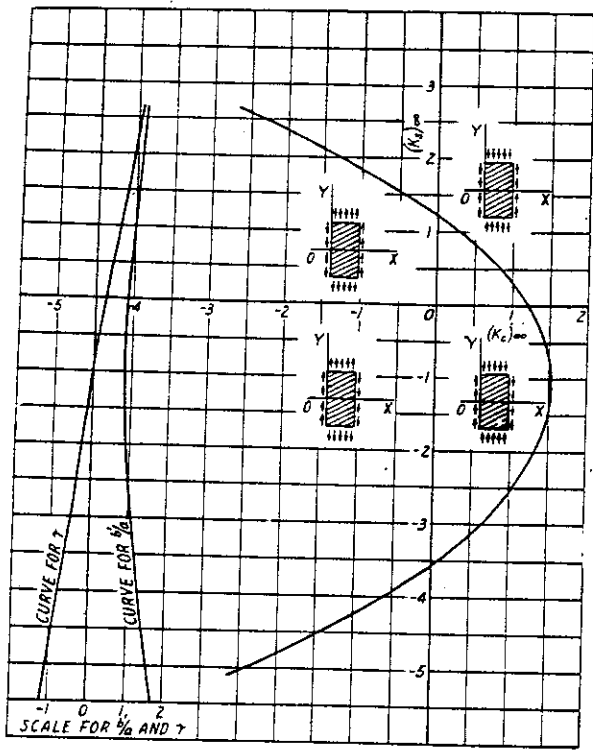

(e)
5-PLY (1:1:1:1:1) $\beta = 60^\circ$

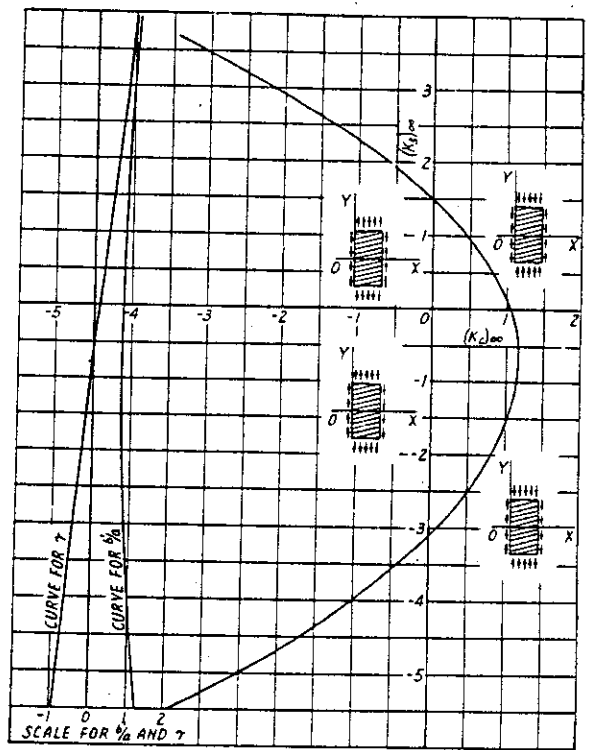

(f)
5-PLY (1:1:1:1:1) $\beta = 75^\circ$

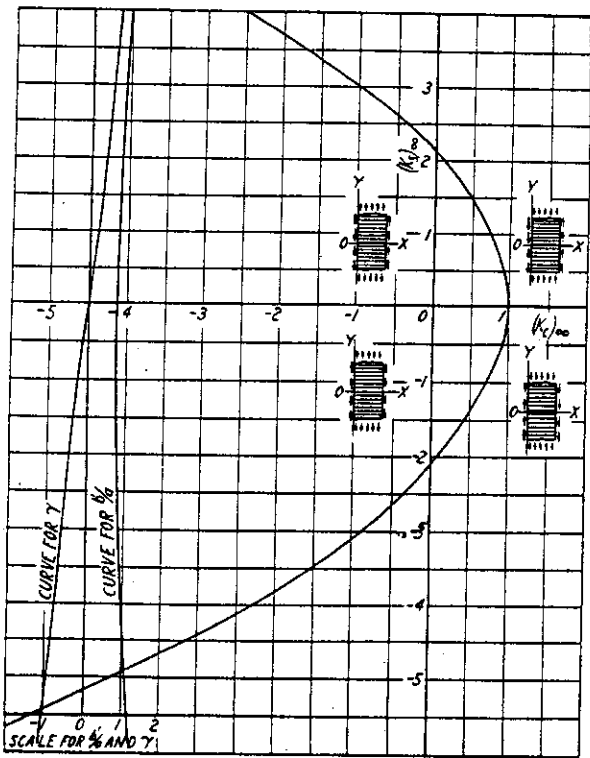

(g)
5-PLY (1:1:1:1:1) $\beta = 90^\circ$

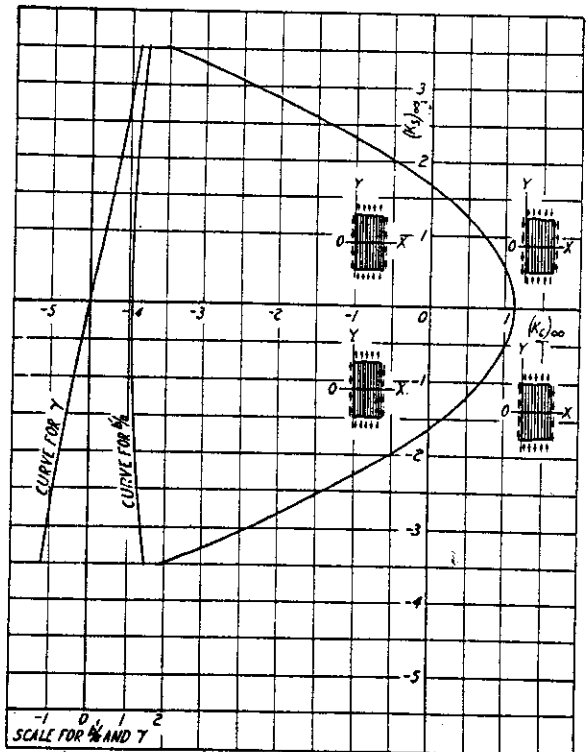

(h)
5-PLY (1:2:2:2:1) $\beta = 0^\circ$

Figure 2-84 (e, f, g, h)—Continued.

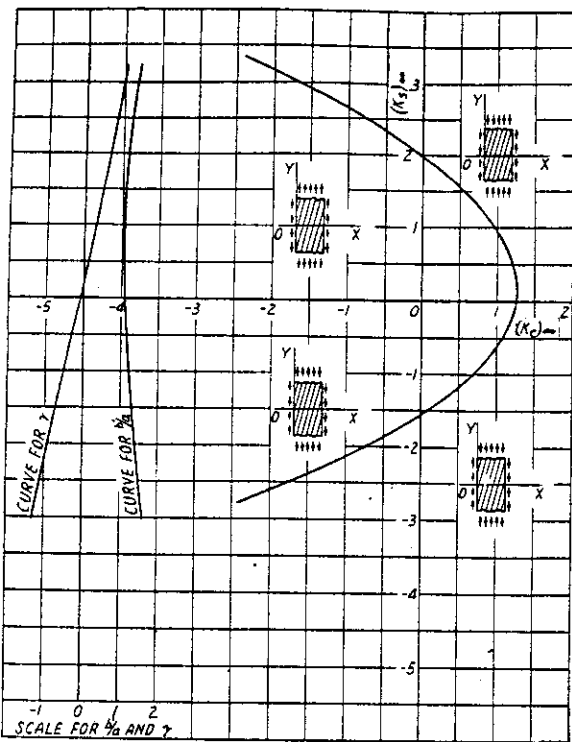

(i)
5-PLY (1:2:2:2:1) $\beta = 15^\circ$

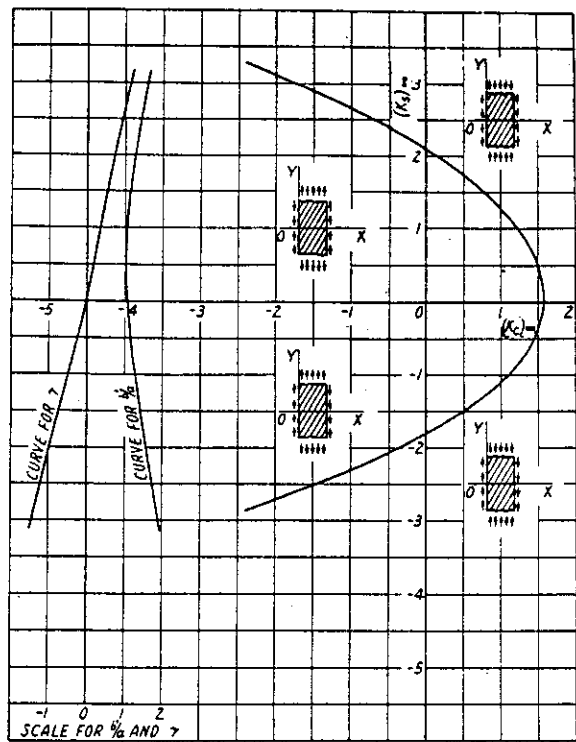

(j)
5-PLY (1:2:2:2:1) $\beta = 30^\circ$

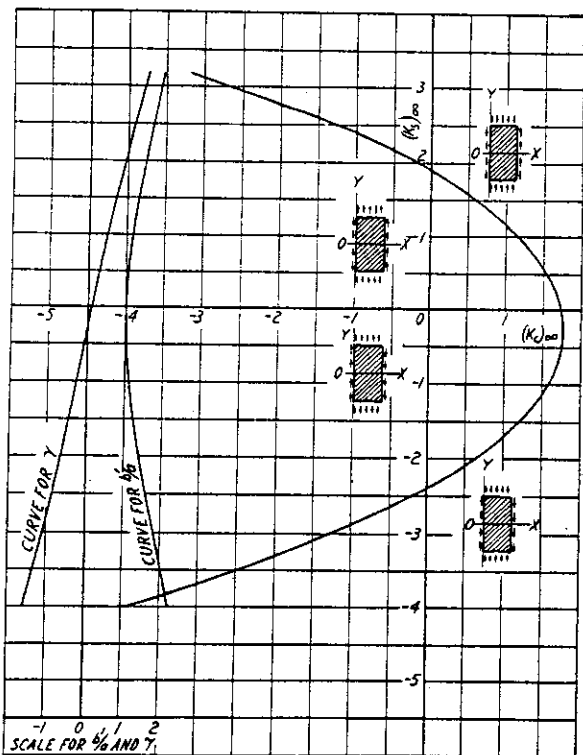

(k)
5-PLY (1:2:2:2:1) $\beta = 45^\circ$

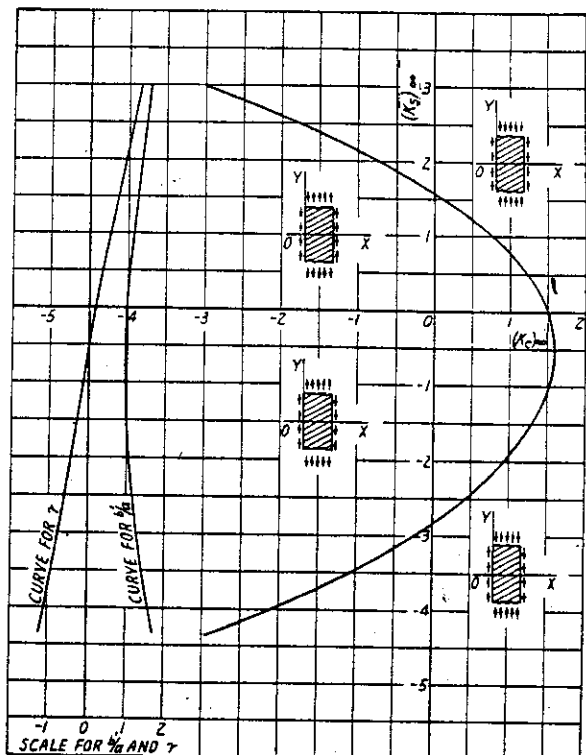

(m)
5-PLY (1:2:2:2:1) $\beta = 60^\circ$

Figure 2-34 (i, j, k, m) — Continued.

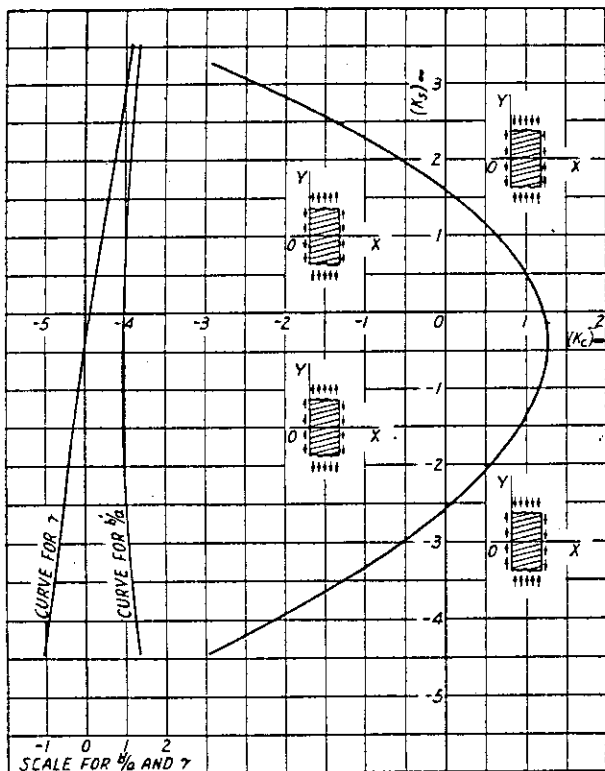

(n)
5-PLY (1:2:2:2:1) $\beta = 75^\circ$

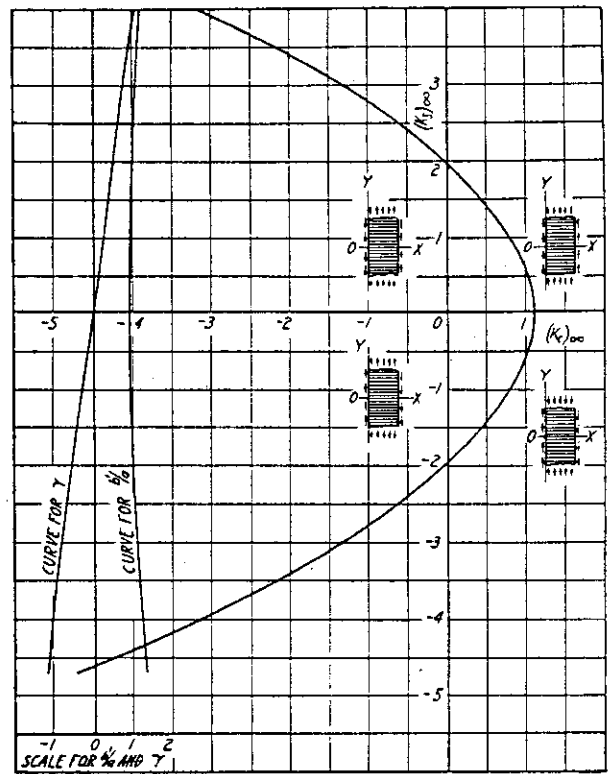

(p)
5-PLY (1:2:2:2:1) $\beta = 90^\circ$

Figure 2-34 (n, p)—Continued.

recting $K_{s,\infty}$ values or $K_{c,\infty}$ values in table 2-14 for panel size by means of figure 2-37. In using these figures b'/a is first obtained from table 2-14 and b/b' computed. For a more exact determination of K_s or K_c or to determine these buckling constants for a plywood construction different from those specified in AN-NN-P-511b or figures 2-30 to 2-36, calculate $\frac{E_{fw}}{E_{fw} + E_{fs}}$ in accordance with section 2.52, read $K_{s,\infty}$ or $K_{c,\infty}$ and b'/a from figures 2-38 to 2-41 and correct for panel size by means of figure 2-37.

2.7151. *Combined compression (or tension) and shear.* The analytical method of determining the critical buckling stresses for rectangular panels subjected to combined loadings is quite complicated, and only the graphical solutions for a few types of plywood construction are given in figures 2-30 to 2-36.

When the plywood construction being used is not the same as any of those illustrated, its buckling constants may be obtained by a straight line interpolation (or extrapolation), on the basis

of $\frac{E_{fw}}{E_{fw} + E_{fs}}$, of the buckling constants for two plywood constructions whose values of the ratio $\frac{E_{fw}}{E_{fw} + E_{fs}}$ are fairly close to that of the plywood under consideration. The values of these ratios for the plywood constructions considered in figures 2-30 to 2-36 may be calculated with sufficient accuracy by assuming $E_T = 0.05 E_L$.

These figures apply to panels of infinite length and values of the buckling constants from the curves must be corrected for actual panel length. Values of the shear constant $K_{s,\infty}$ and the compression constant $K_{c,\infty}$ are indicated on the vertical and horizontal axes, respectively. The points at which the curve crosses these axes give the values of $K_{s,\infty}$ or $K_{c,\infty}$ at which buckling will just occur in a panel of infinite length in either pure shear or pure compression. The particular combination of stresses represented by each of the four quadrants is shown by the small stress sketches. Buckling will occur under these combined stresses whenever the location of a point $K_{s,\infty}, K_{c,\infty}$, lies on or outside the curve.

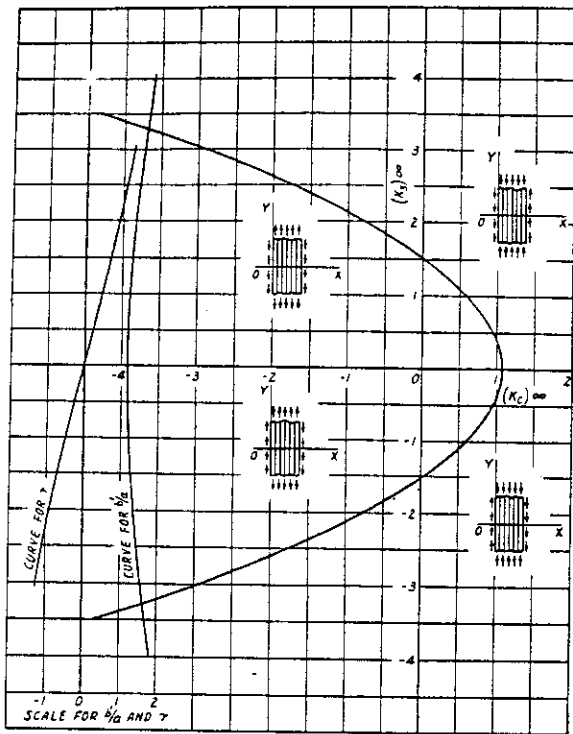

(a)
9-PLY (|||||) $\beta = 0^\circ$

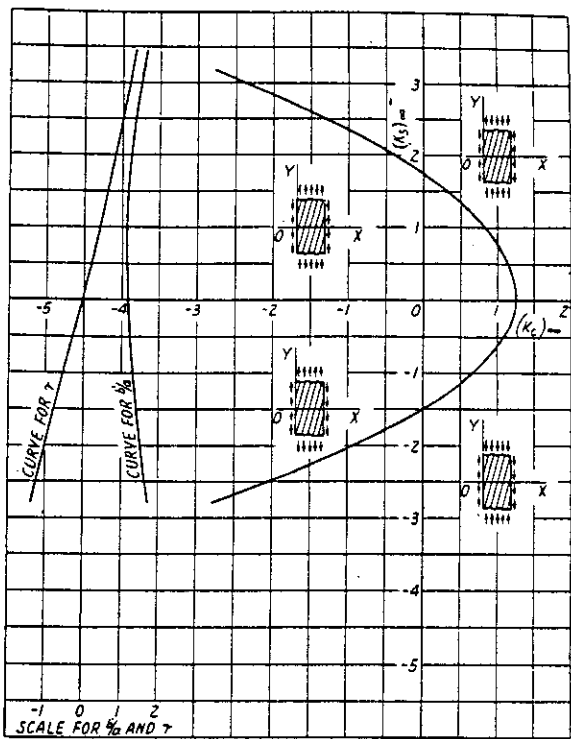

(b)
9-PLY (|||||) $\beta = 15^\circ$

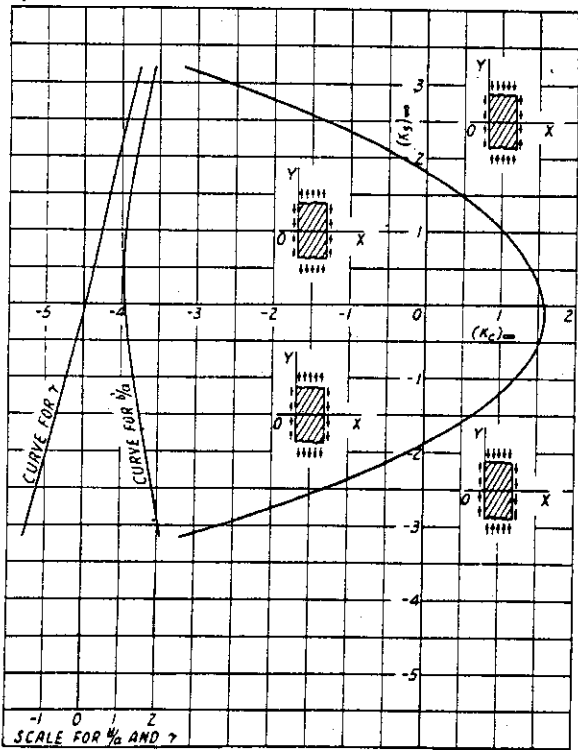

(c)
9-PLY (|||||) $\beta = 30^\circ$

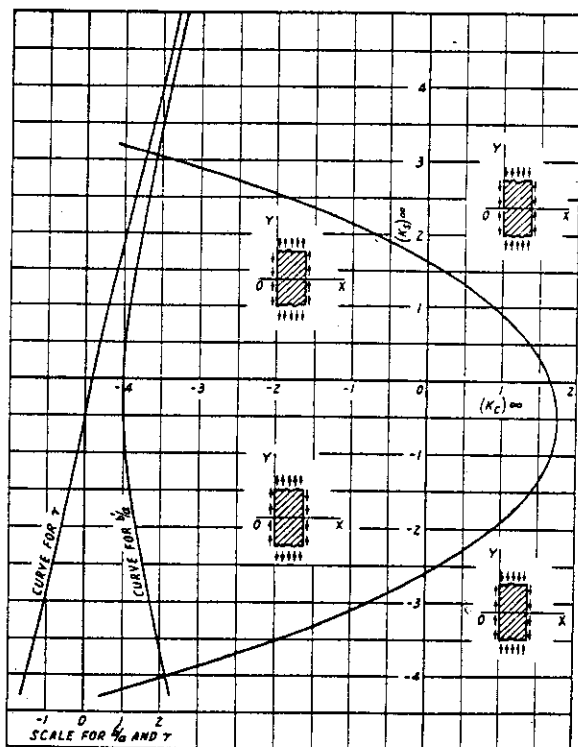

(d)
9-PLY (|||||) $\beta = 45^\circ$

Figure 2-35 (a, b, c, d). Curves of critical buckling constants for infinitely long rectangular plywood panels under combined loading. Edges simply supported. β = angle between face grain and direction of applied stress. Nine-ply construction.

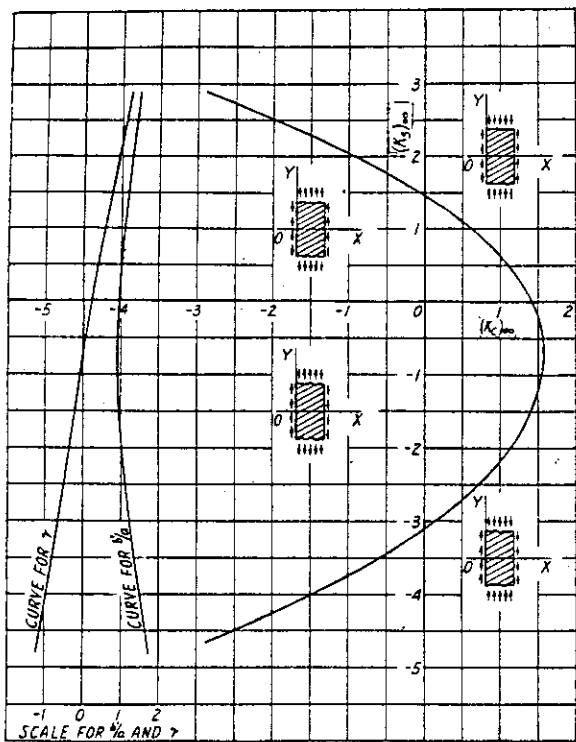

(e)
9-PLY (1:1:1:1:1:1:1) $\beta = 60^\circ$

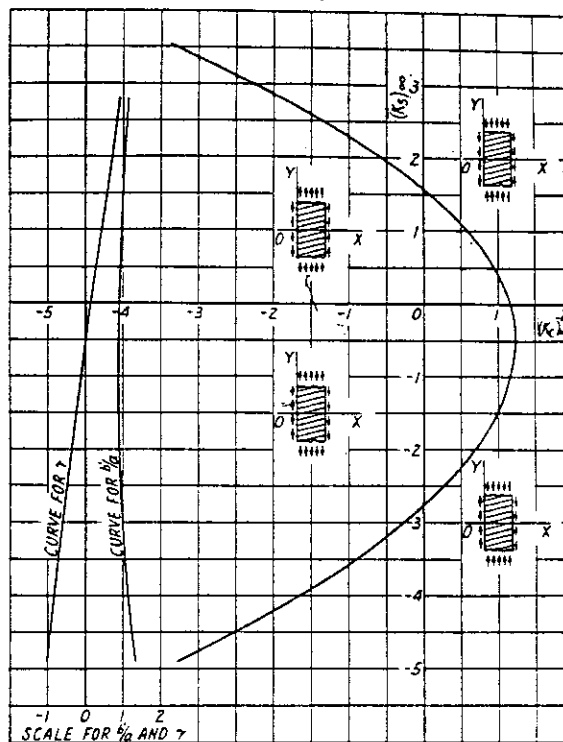

(f)
9-PLY (1:1:1:1:1:1:1) $\beta = 75^\circ$

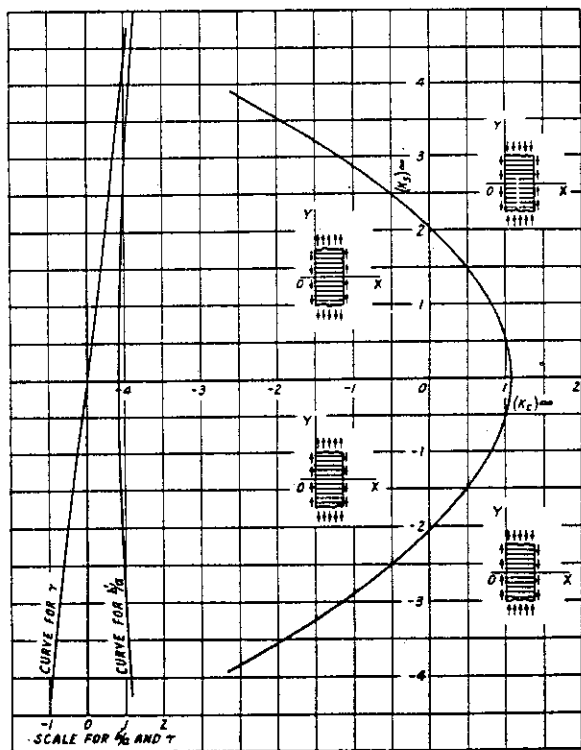

Z. M. 50613 5
(g)
9-PLY (1:1:1:1:1:1:1) $\beta = 50^\circ$

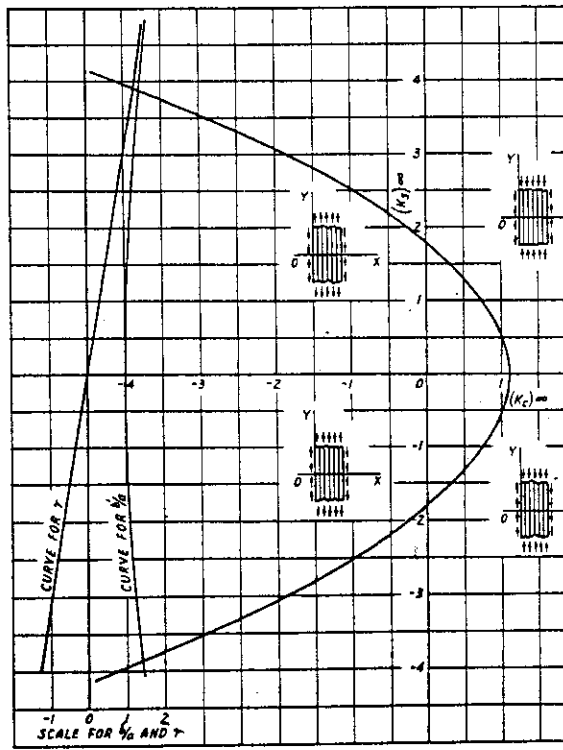

(h)
9-PLY (1:2:2:2:2:2:2:1) $\beta = 0^\circ$

Figure 2-35 (e, f, g, h)—Continued.

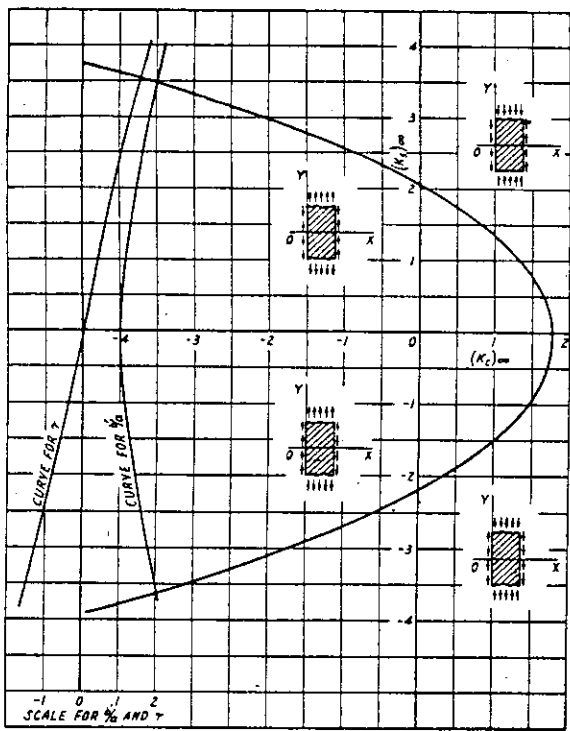

(i)
9-PLY (1:2:2:2:2:2:2:2:1) $\beta = 45^\circ$

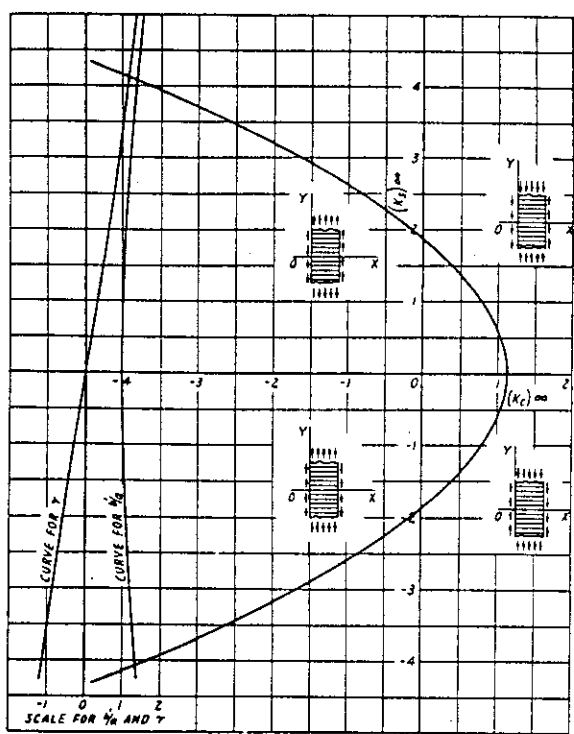

(j)
9 PLY (1:2:2:2:2:2:2:2:1) $\beta = 90^\circ$

Figure 2-35 (i, j)—Continued.

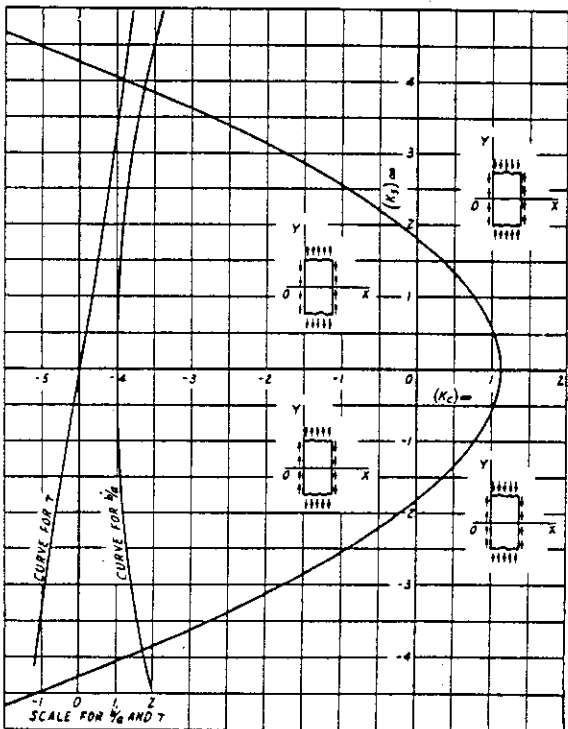

(a)
 ∞ -PLY $\beta = 0^\circ$ AND $\beta = 90^\circ$

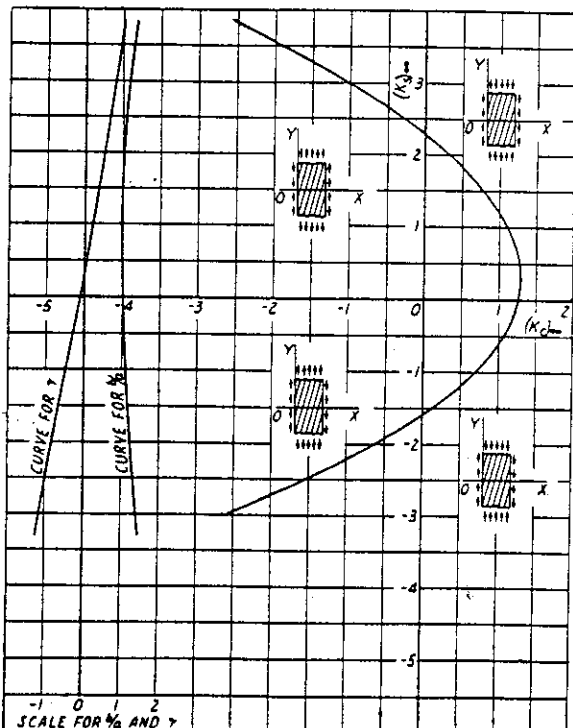

(b)
 ∞ -PLY $\beta = 15^\circ$

Figure 2-36 (a, b). Curves of critical buckling constants for infinitely long rectangular plywood panels under combined loading. Edges simply supported. β = angle between face grain and direction of applied stress. Infinite-ply construction.

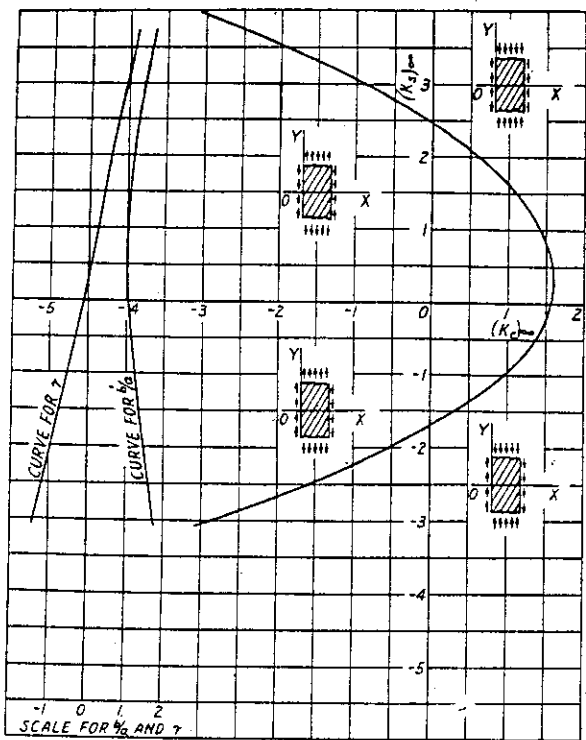

(c)
 ∞ -PLY $\beta = 30^\circ$

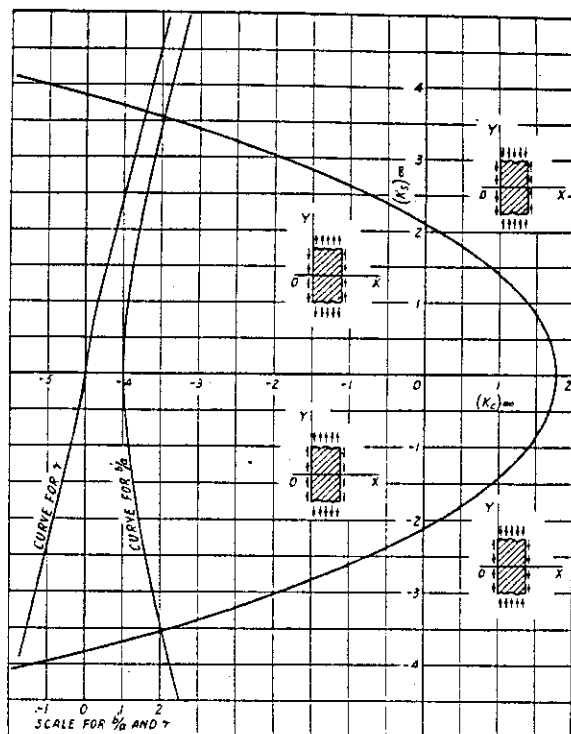

(d)
 ∞ -PLY $\beta = 45^\circ$

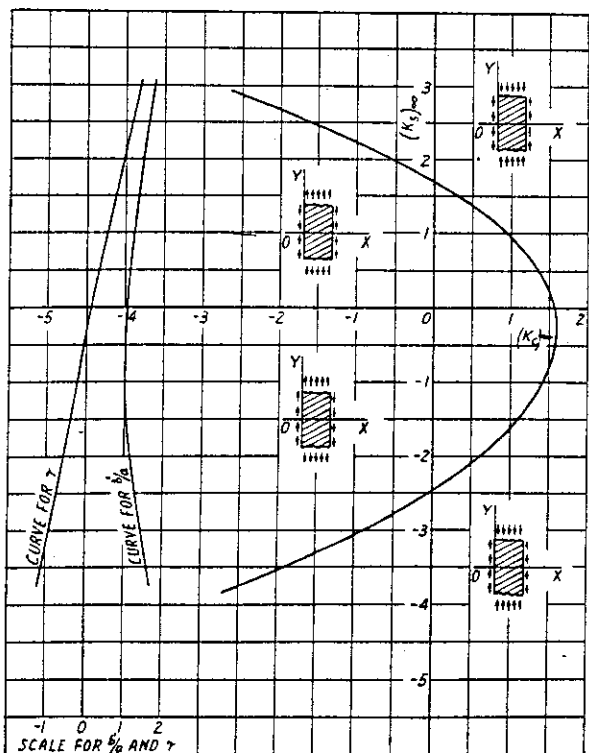

(e)
 ∞ -PLY $\beta = 60^\circ$

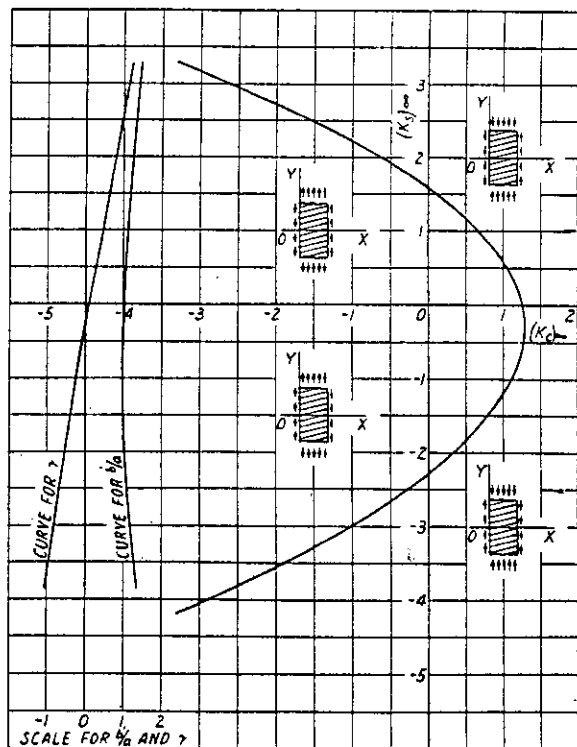

(f)
 ∞ -PLY $\beta = 75^\circ$

Figure 2-36 (c, d, e, f)—Continued.

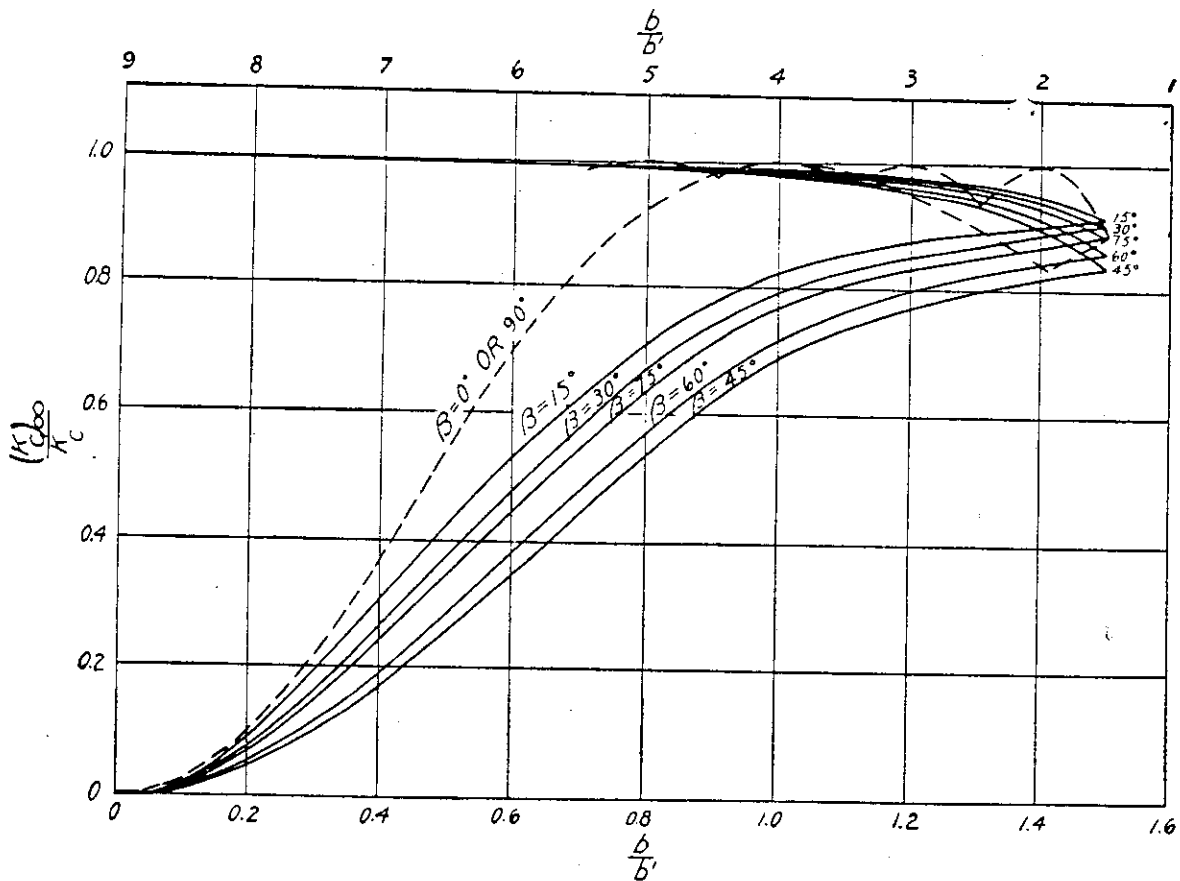
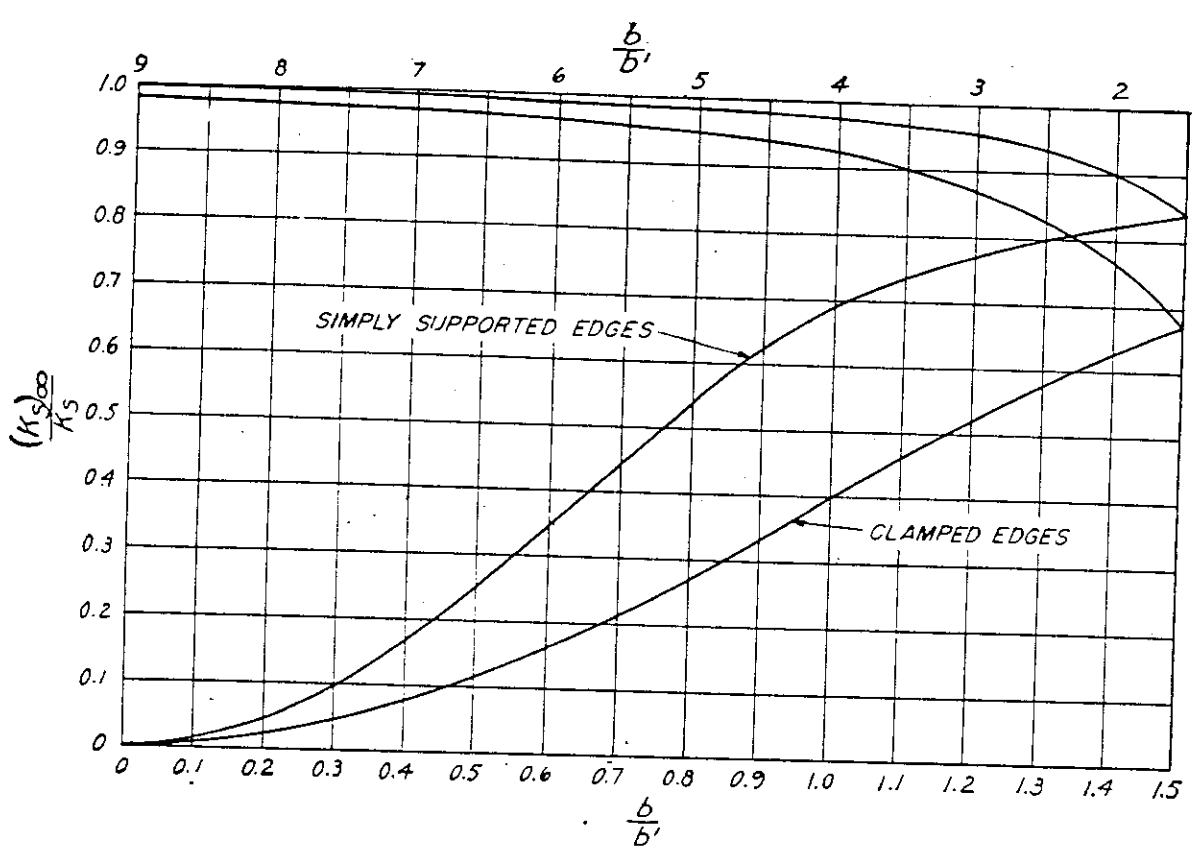

Figure 2-37. Corrections for panel size: Top, when $\beta = 0^\circ, 45^\circ,$ or 90° and panel is subjected to shear stress; bottom, when the panel is subjected to compression with the edges simply supported and $\beta = 0^\circ$ or 90° is a computed curve (ref. 2-50).

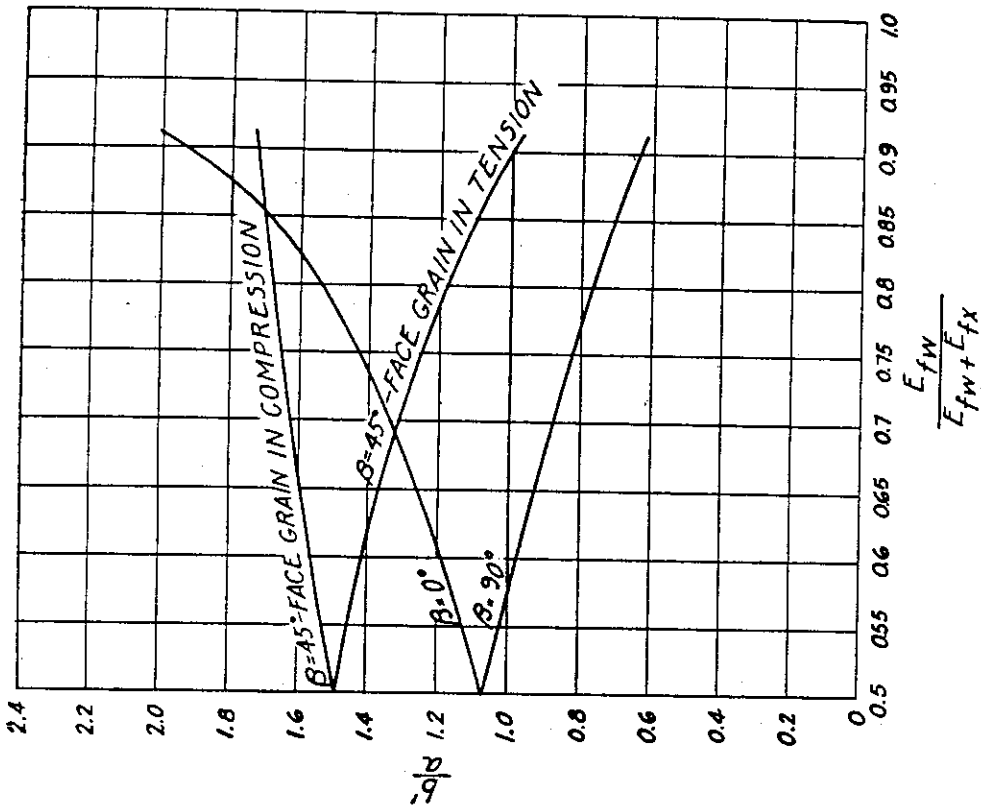
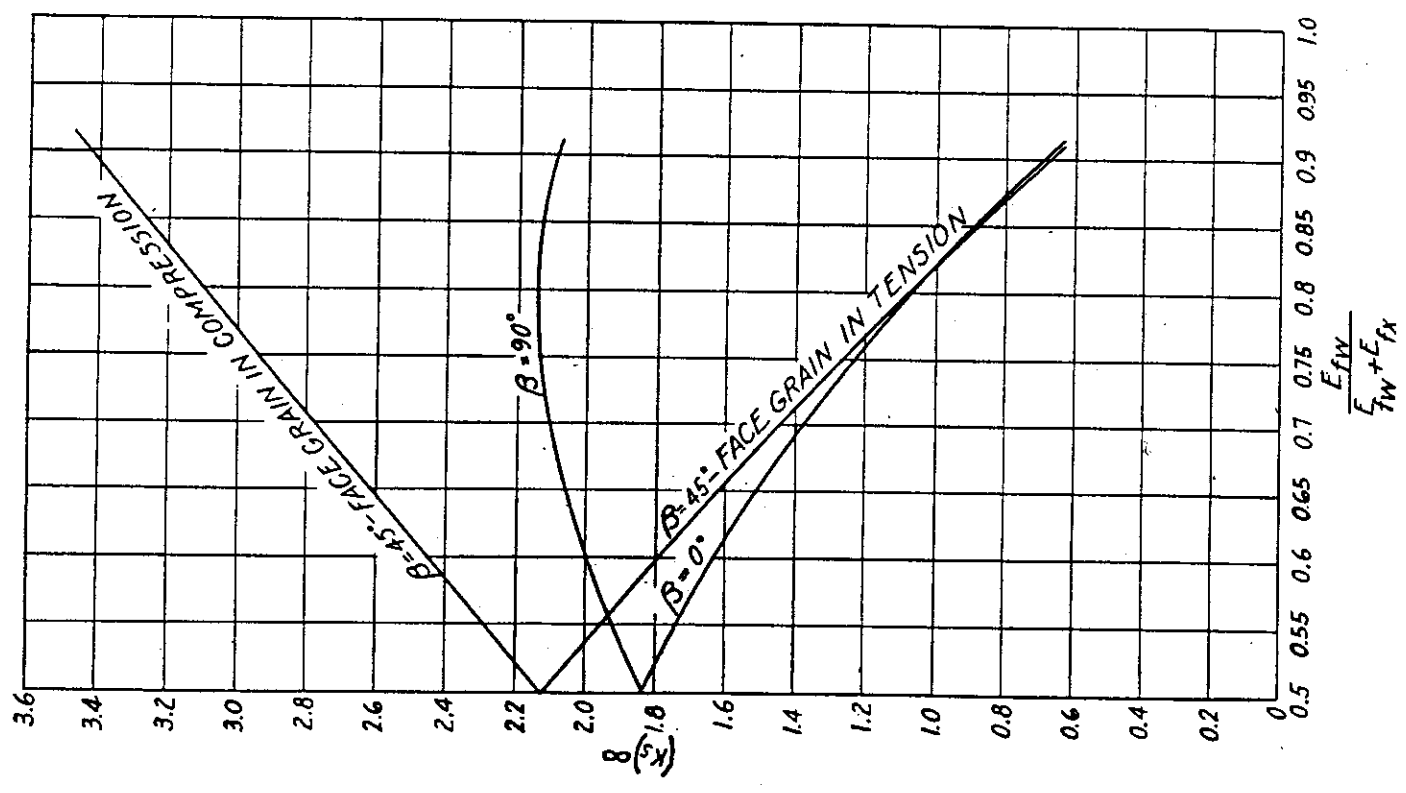

Figure 2-38 (left). Buckling of infinitely long plates of symmetrical construction under uniform shear for determination of $(K)_\infty$. Edges simply supported.

Figure 2-39. Buckling of infinitely long plates of symmetrical construction under uniform shear for determination of b/a . Edges simply supported.



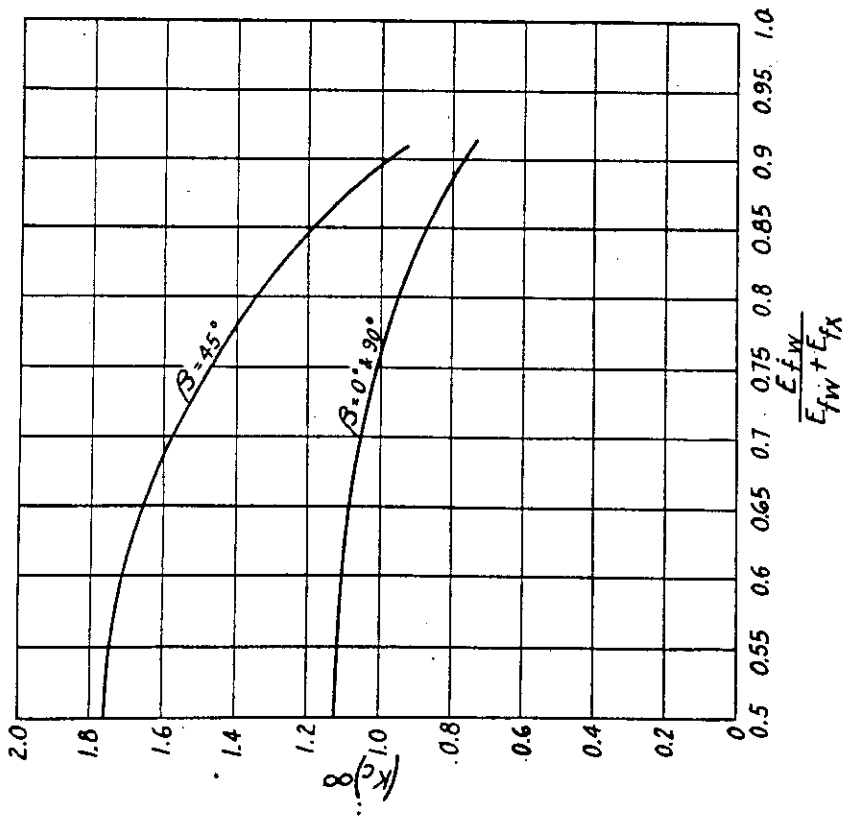

Figure 2-40. Buckling of infinitely long plates of symmetrical construction under uniform compression for determination of $(K_c)_\infty$. Edges simply supported.

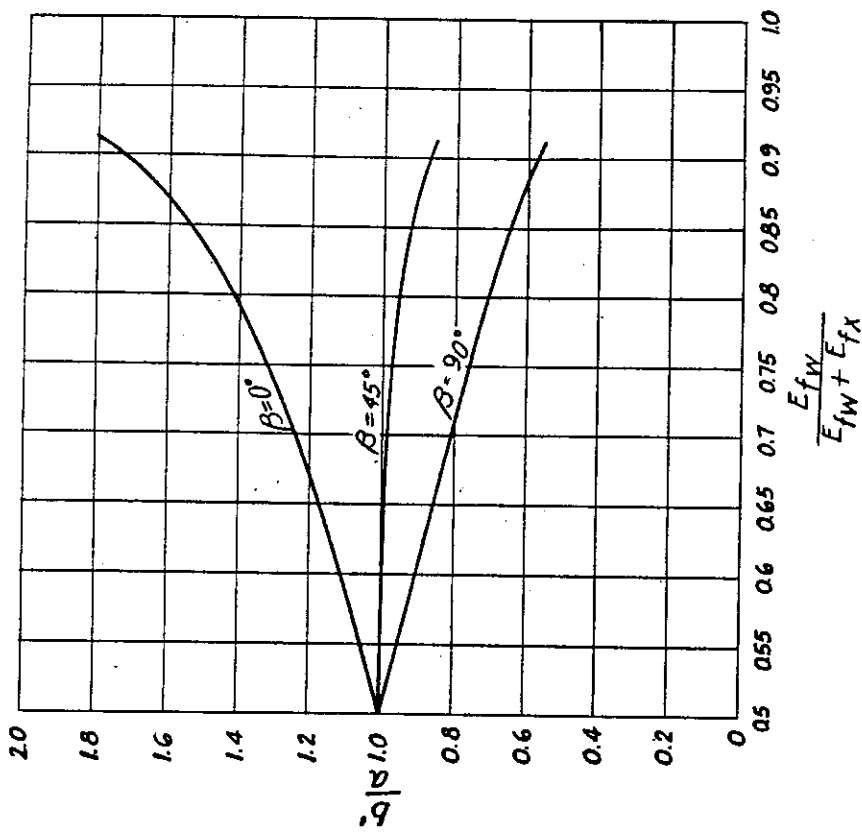
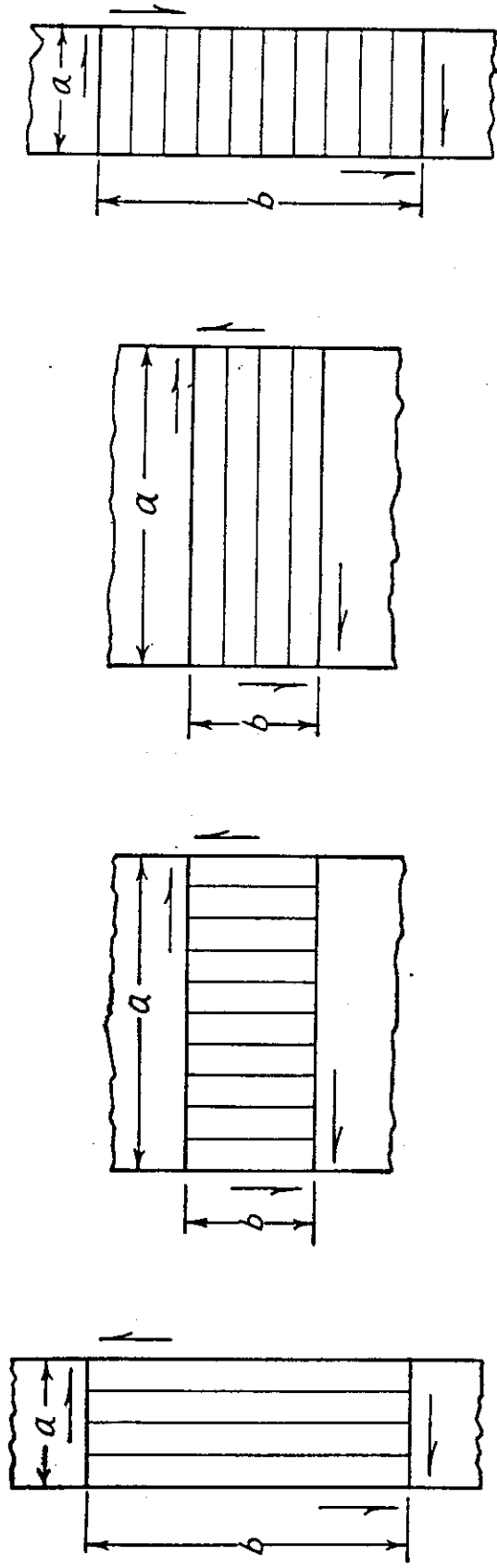

Figure 2-41. Buckling of infinitely long plates of symmetrical construction under uniform compression for determination of b'/a . Edges simply supported.



$\beta=0^\circ$

$\beta=90^\circ$

Figure 2-42. In panels loaded in shear, a may be a dimension of either edge. For $\beta=0^\circ$, face grain is perpendicular to a ; for $\beta=90^\circ$, face grain is parallel to a .

Table 2-14. Buckling constants for plywood¹

THREE-PLY

Face grain angle	Shear								Compression					
	0°		90°		45°				0°	0° and 90°	90°	45°		
	(K) _∞	b'/a	(K) _∞	b'/a	Face grain in tension		Face grain in compression					b'/a	(K) _∞	b'/a
Nominal thickness	(2)	(3)	(4)	(5)	(6)	(7)	(8)	(9)	(10)	(11)	(12)	(13)	(14)	
Inch														
0.035	0.60	2.13	2.05	0.60	0.57	0.95	3.50	1.74	1.88	0.71	0.53	0.86	0.84	
.070	.80	1.79	2.11	.68	.78	1.06	3.34	1.72	1.62	.82	.62	1.08	.91	
.100	.75	1.85	2.10	.66	.73	1.03	3.38	1.72	1.67	.80	.60	1.03	.90	
.125	.88	1.70	2.13	.71	.87	1.10	3.27	1.71	1.55	.87	.65	1.17	.93	
.155	.94	1.65	2.14	.72	.93	1.12	3.22	1.70	1.50	.89	.67	1.23	.94	
.185	.95	1.64	2.14	.73	.94	1.13	3.22	1.70	1.50	.90	.68	1.24	.94	

FIVE-PLY

0.160	1.25	1.42	2.13	0.83	1.29	1.26	2.91	1.66	1.31	1.02	0.77	1.49	0.97
.190	1.35	1.36	2.12	.87	1.41	1.30	2.81	1.64	1.26	1.04	.80	1.56	.98
.225	1.37	1.35	2.11	.88	1.43	1.31	2.79	1.63	1.25	1.05	.81	1.57	.98
.250	1.30	1.38	2.12	.85	1.35	1.28	2.86	1.64	1.28	1.04	.79	1.53	.98
.315	1.29	1.39	2.12	.85	1.34	1.28	2.87	1.65	1.29	1.03	.78	1.52	.98
.375	1.48	1.28	2.08	.92	1.57	1.36	2.66	1.60	1.19	1.08	.84	1.64	.99

SEVEN-PLY (all plies of equal thickness)

Any	1.40	1.32	2.10	0.89	1.46	1.32	2.75	1.62	1.23	1.06	0.82	1.59	0.99
-----	------	------	------	------	------	------	------	------	------	------	------	------	------

NINE-PLY (all plies of equal thickness)

Any	1.52	1.26	2.06	0.94	1.63	1.37	2.60	1.59	1.17	1.09	0.86	1.66	0.99
-----	------	------	------	------	------	------	------	------	------	------	------	------	------

ELEVEN-PLY (all plies of equal thickness)

Any	1.59	1.22	2.03	0.96	1.72	1.40	2.52	1.58	1.14	1.10	0.88	1.70	0.99
-----	------	------	------	------	------	------	------	------	------	------	------	------	------

¹ The buckling constants listed in this table correspond only to the plywood thicknesses and constructions listed in table 2-13 that correspond to Army-Navy specification AN-NN-P-511b (Plywood and Veneer; Aircraft Flat Panel). The values in this table were computed as follows: For each construction given in table 2-13 a value of $\frac{E_{fw}}{E_{fw} + E_{fx}}$ was computed from columns 5 and 6 of table 2-13. These values for each thickness were averaged and the average values were used in entering figures 2-38, 2-39, 2-40, and 2-41 from which the values of this table were obtained. For a more exact determination of these buckling constants or to determine the buckling constants of a plywood construction different from those specified in AN-NN-P-511b, see section 2.7.

The curve marked b'/a is the ratio of half the wave length (b') of a buckle in an infinitely long panel to its width (a). This ratio is to be used in conjunction with figures 2-37 to 2-41 in obtaining

the correction factors for panels of finite length to be applied to K_{∞} .

The curves in figures 2-30 to 2-36 marked γ give the slope of the panel wrinkles with respect

to the $O-X$ axis indicated on the stress sketches.

The procedure in the use of these figures is as follows:

- (1) From the analysis the shear stress (f_s) and the compression (f_c) or tension stress ($-f_c$) acting on a particular plywood panel will have been calculated.
- (2) Determine the ratio f_s/f_c and, on the figure giving the same plywood construction and angle β , draw a line through the origin having a slope (positive or negative) equal to this ratio. When the plywood construction is not the same as that given in the figures, this procedure for determining the buckling constant will have to be run through on the two most similar constructions and an interpolation of the results made on the basis of

$$\frac{E_{f_{sc}}}{E_{f_{sc}} + E_{f_{tc}}}$$

- (3) The point at which the constructed line crosses the curve gives the critical buckling constants K_{sc} and K_{tc} at which an infinitely long panel will just buckle when subjected to the same ratio of shear to compression that exists on the panel in question.
- (4) Read the value of b'/a for the point on the b'/a curve which is obtained by projecting horizontally from K_{sc} determined in step (3).
- (5) From the panel dimensions compute b' and b/b' .
- (6) Figures 2-37 to 2-41 will give the ratio of K_s/K_{sc} from which the value of K_s can be computed (K_s is always taken as positive).
- (7) The critical buckling shear stress (F_{scr}) may then be determined by equation (2:80). This represents the maximum allowable shear stress which the panel in question can sustain without buckling when subjected simultaneously to a compressive stress equal to that given in step (1).

2.72. STRENGTH AFTER BUCKLING.

2.721. *General.* Plywood panels may sustain greater loads than those sufficient to cause buckling. When buckling takes place the stresses within the panel are redistributed, the maximum stresses occurring at the edges. The panel will continue to accept load until these stresses reach

the ultimate value. The load at failure is obtained from empirical curves in which the ratio of the average stress at failure to the ultimate strength of the plywood is plotted against the ratio of the width of the panel to the width of a hypothetical panel that will fail at its buckling load.

2.722. *Compression* ($\beta = \text{any angle}$). The abscissa of figure 2-43 is obtained from the equation

$$\frac{a}{a_0} = \sqrt{\frac{F_{cu\theta}}{F_{scr}}} \quad (2:81)$$

in which $F_{cu\theta}$ is obtained from equation (2:51) or (2:52) and F_{scr} from equation (2:77) or (2:79). The ordinates give the ratio of the average stress at which failure will occur to the ultimate compressive strength ($F_{cu\theta}$) of the plywood.

2.723. *Shear* ($\beta = 0^\circ, 45^\circ, \text{ or } 90^\circ$). The abscissa of figure 2-44 is obtained from the equation

$$\frac{a}{a_0} = \sqrt{\frac{F_s}{F_{scr}}} \quad (2:82)$$

in which F_s is obtained from equation (2:50) (2:57), or (2:58) and F_{scr} from equation (2:77) or (2:80). The ordinates give the ratio of the average stress at which failure will take place to the ultimate shear stress (F_s) of the plywood.

2.73. ALLOWABLE SHEAR IN PLYWOOD WEBS.

2.730. *General.* Beams are required to have a high strength-weight ratio and, therefore, they are generally designed so that they will fail in shear at about the load which will cause bending failures. A higher strength-weight ratio is usually obtained if the beams fail in bending before shear failure can occur.

Plywood when used as webs of beams is subjected to different stress conditions from those when it is used in simple shear frames. It is essential, therefore, that tests to determine the strengths of shear webs be made upon specimen beams designed with flanges only sufficiently strong to hold the load at which shear failure is expected. Plywood webs tested in heavy shear frames with hinged corners will give shear strengths that are too high for direct application to beam design.

In any case where buckling is obtained, the stiffeners must have adequate strength to resist the additional loads due to such buckling, and the webs must be fastened to the flanges in such a manner as to overcome the tendency of the buckles in the web to project themselves into this fastening and cause premature failure (ref. 2-23 and 2-42).

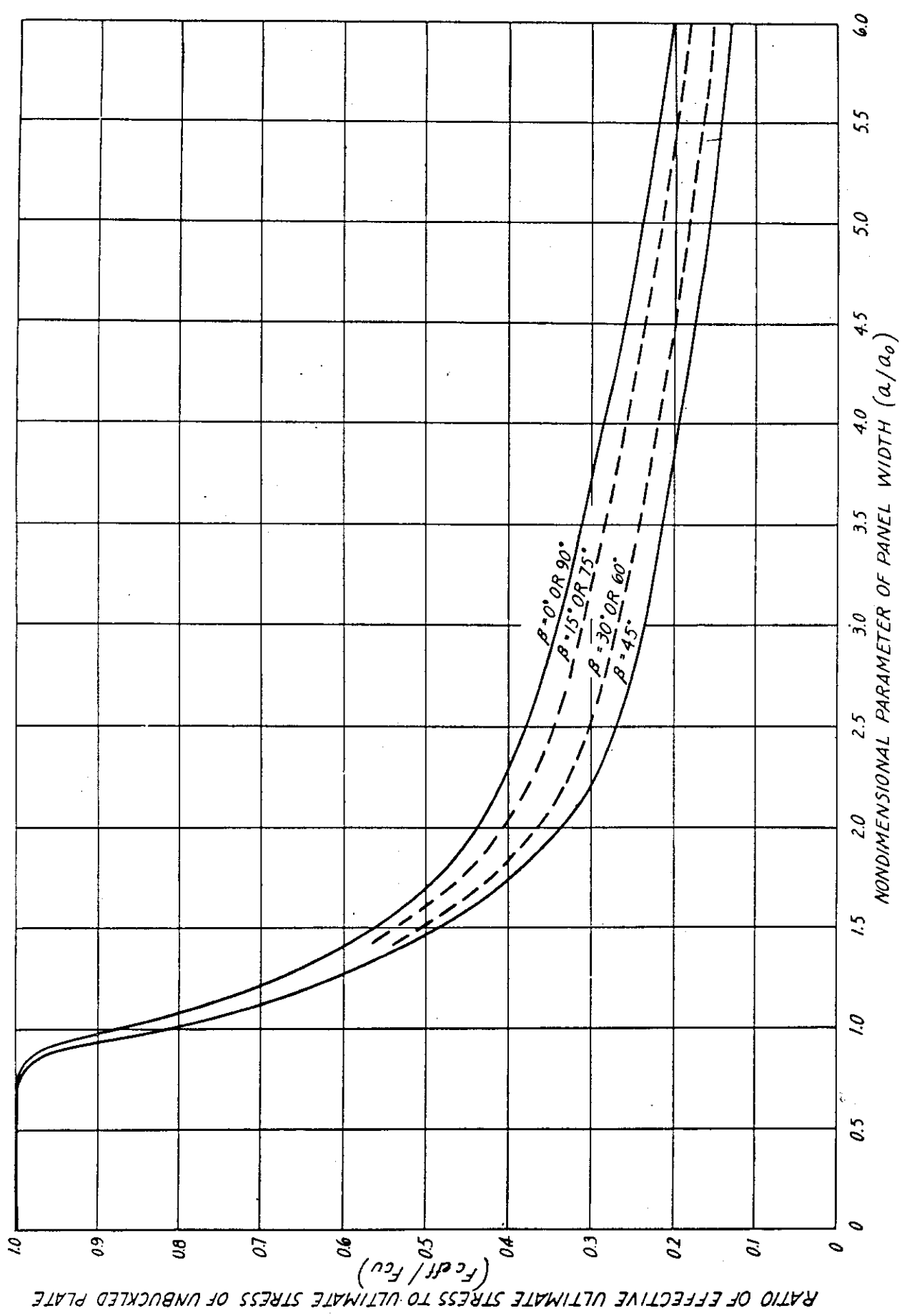

Figure 2-43. Effective width of flat plywood plates in compression at 0° , 15° , 30° , 45° , 60° , 75° , or 90° to direction of face grain. (Curves based on buckling tests of plates and compression tests of coupons 1 inch wide by 4 inches long for 0° or 90° and 6 inches wide by 2 inches long for 15° , 30° , 45° , 60° , or 75° .)

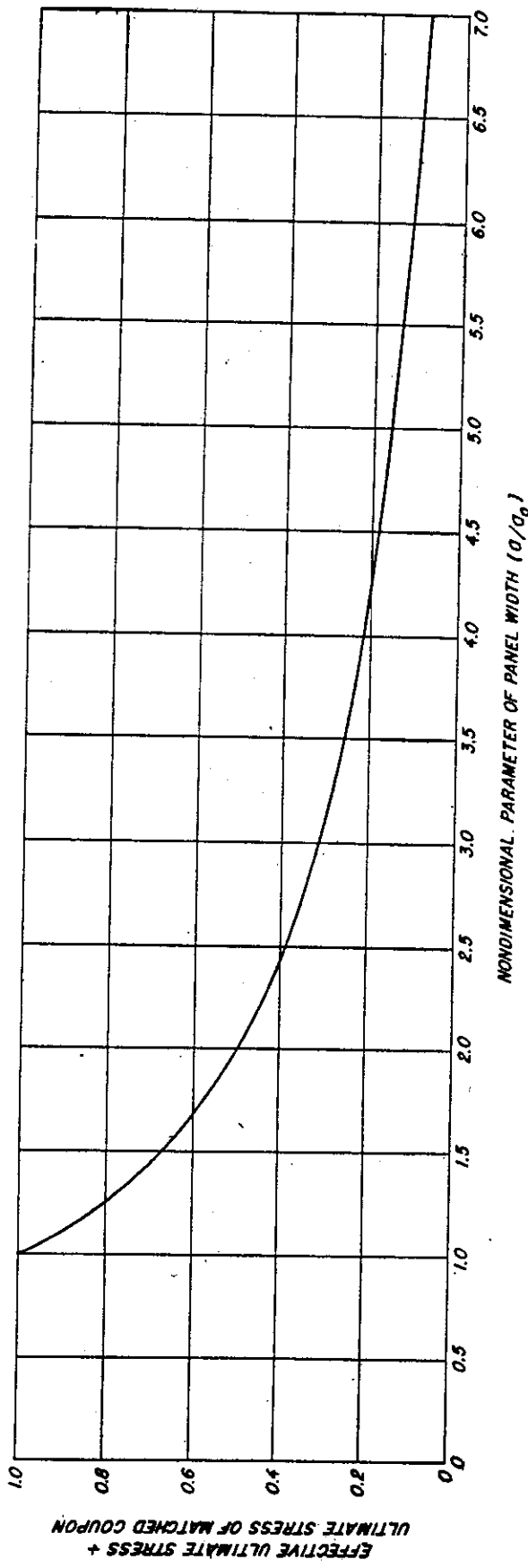

Figure 2-44. Effective ultimate stress divided by ultimate stress of matched coupon.

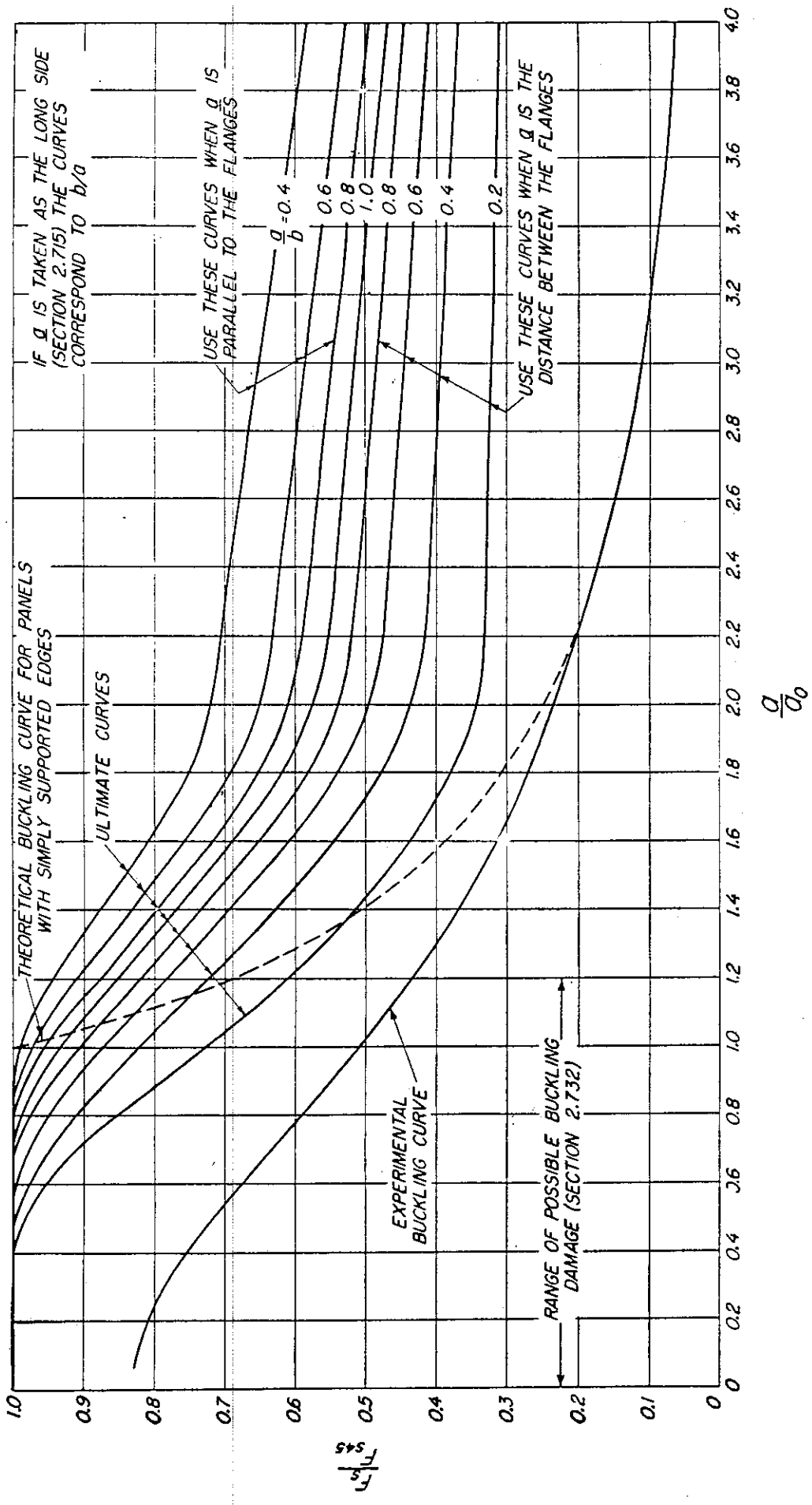

Figure 2-45. Allowable ultimate stress and probable buckling stress for plywood webs in shear. These curves were obtained by using constants for panels with simply supported edges; they do not apply when clamped-edge constants are used.

2.731. *Allowable shear stresses.* The allowable shear stresses of plywood webs having the face grain direction at 0°, 45°, or 90° to the main beam axis may be obtained from figure 2-45.

Values of the parameter $\frac{a}{a_0}$ are obtained from equation (2:82) as explained in section 2.723. Each curve of the family shown in the figure is similar to the curve of figure 2-44. The allowable shear stress (F_s) for the web can be obtained in terms of F_s/F_{s0} from figure 2-45. (For a/a_0 values greater than 4.0, the a/b curves may be extrapolated as straight lines to meet at a point corresponding to $a/a_0=10$ and $F_s/F_{s0}=0.2$.)

The direct use of figure 2-45 for any type of beam having 45° shear webs has been verified by numerous tests of I- and box-beams. A few exploratory tests of beams having 0° and 90° plywood shear webs has indicated that the allowable ultimate shear stresses obtained for these constructions by using figure 2-45 are conservative.

Plywood shear webs of 45° are more efficient than 0° or 90° webs.

The designer is cautioned that box beams may fail at a load lower than that indicated by the strength of the webs as shown in figure 2-45, because of inadequate glue areas of webs at stiffeners or flanges. Such premature failures result from a separation of the web from the flanges or stiffeners.

Figure 2-45 contains a parameter a/b in the form of a family of curves. The $a/b=1$ curve represents a spacing between stiffeners just equal to the clear depth between flanges. The curves below $a/b=1$ should be used for the design of shear webs of beams whose stiffener spacing exceeds the clear distance between flanges. The upper set of curves should be used for the design of beams whose stiffener spacing is less than the clear distance between flanges.

2.732. *Buckling of plywood shear webs.* In connection with shear web tests on various types of beams, it was observed that for plywood webs in the a/a_0 range of less than 1.2, buckling was of the inelastic type that often caused visible damage soon after buckling and sometimes just as the buckles appeared for those webs designed to fail in the neighborhood of F_{s0} . No accurate criteria can be presented at this time, but the designer is cautioned to avoid the use of webs that may be damaged by buckling before the limit or yield stress is reached. The buckling curve established by these tests is shown in figure 2-45.

2.74. **LIGHTENING HOLES.** When the computed

shear stress for a full depth web of practical design is relatively low, as in some rib designs, the efficiency, or strength-weight ratio, may be increased by the careful use of lightening holes and reinforcements. General theoretical or empirical methods for determining the strength of plywood webs with lightening holes are not available, and tests should, therefore, be made for specific cases (ref. 2-64).

2.75. **TORSIONAL STRENGTH AND RIGIDITY OF BOX SPARS.** The maximum shear stresses in plywood webs for most types of box spars subjected to torsion may be calculated from the following formula:

$$f_s = \frac{T}{b't(C' - 2b't)} \quad (2:83)$$

where

t = thickness of one web

b' = mean width of spar (total width minus thickness of one web)

C' = average of the outside and inside periphery of the cross section.

The allowable ultimate stress in torsion of plywood webs is determined as in section 2.723.

The torsional rigidity of box beams up to the proportional limit, or to the buckling stress (whichever is the lesser) is given by the formula:

$$\theta = \frac{TC'L}{4Gtb'(C' - 2b't)^2} \quad (2:84)$$

2.76. **PLYWOOD PANELS UNDER NORMAL LOADS.**

2.760. *General.* When rectangular plywood panels, which have the face grain direction parallel or perpendicular to the edges, are subjected to normal loads, the deflections and in some cases the stresses developed, are given by the following approximate formulas. If the maximum panel deflection exceeds about one-half its thickness, the formulas for large deflections will give results which are somewhat more accurate than those given by the formulas for small deflections (ref. 2-51).

2.761. *Small deflections.*

(a) Uniform load—all edges simply supported.

$$w_0 = 0.155 K_1 \frac{pa^4}{E_1 t^3} \quad (2:85)$$

where

w_0 = deflection at center of panel

p = load per unit area

a = width of plate (short side)

K_1 = constant from figure 2-46 (a)

The maximum bending moment at the center of the panel on a section perpendicular to side a

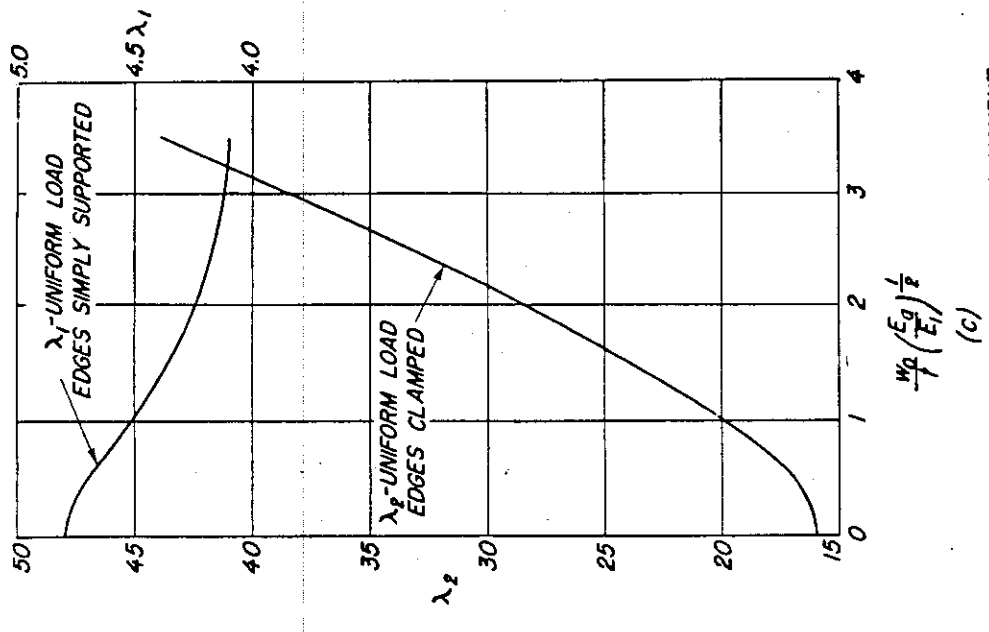
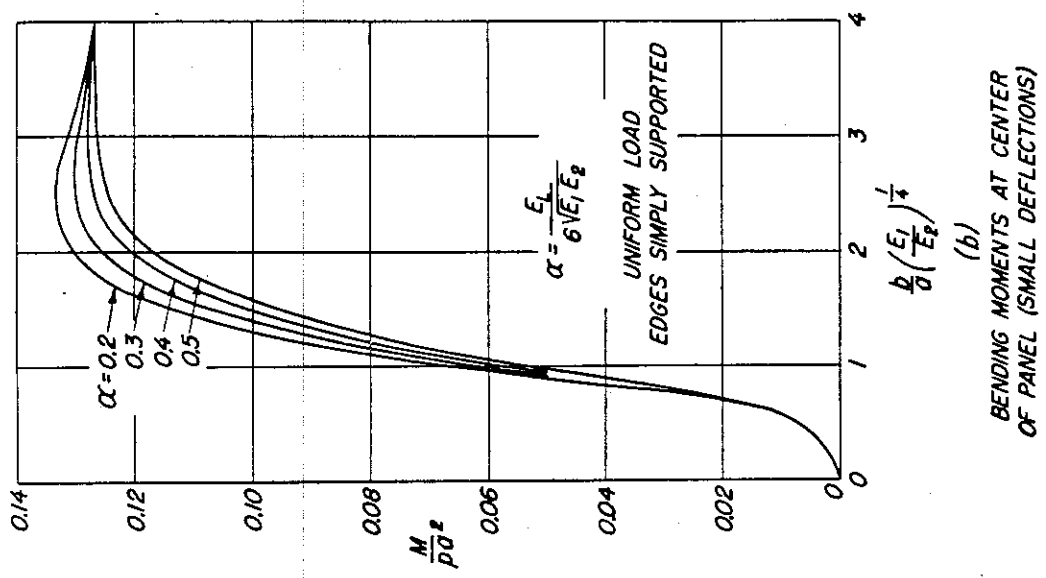
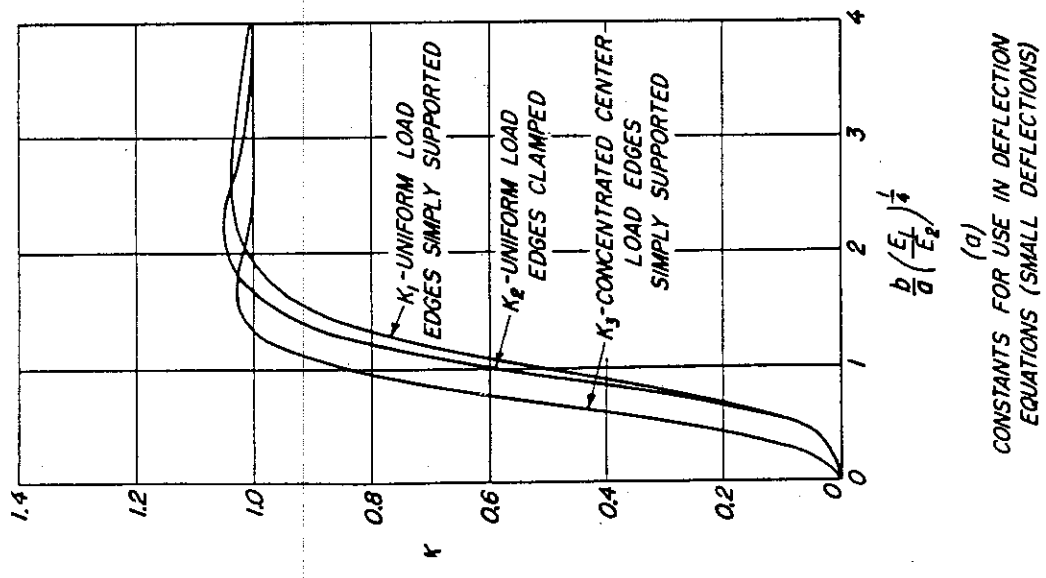

Figure 2-46. Curves of bending moments and deflection constants for flat rectangular plywood panels subjected to normal loads.

may be obtained from figure 2-46 (b). The maximum bending moment on a section perpendicular to side b is given by the same curve, provided a and b , and E_1 and E_2 are interchanged in the abscissa, and a is replaced by b in the ordinate. The corresponding stresses can be calculated from the formulas given in section 2.614.

(b) Uniform load—all edges clamped.

$$w_o = 0.031 K_2 \frac{pa^4}{E_1 t^3} \quad (2:86)$$

where

K_2 = constant from figure 2-46 (a)

(c) Concentrated load at center—all edges simply supported.

$$w_o = 0.252 K_3 \left(\frac{E_1}{E_2} \right)^{1/4} \frac{Pa^2}{E_1 t^3} \quad (2:87)$$

where

K_3 = constant from figure 2-46 (a).

2.762. Large deflections.

(a) Uniform load—all edges simply supported.

The relation between the load and deflection is given by the formula:

$$p = K_4 E_L w_o \frac{t^3}{a^4} + K_5 E_L w_o^3 \frac{t}{a^4} \quad (2:88)$$

where

K_4 and K_5 are constants whose approximate values are given in table 2-15.

E_L is taken for the species of the face ply.

The maximum bending moment at the center of the panel can be calculated from the following approximate formula provided the length of the panel exceeds its width by a moderate amount.

$$M_{\max} = \lambda_1 E_1 w_o \frac{t^3}{6a^2} \quad (\text{long narrow panels only}) \quad (2:89)$$

where

λ_1 = constant from figure 2-46 (c).

Although the edge support conditions are taken as simply supported, it is assumed that the panel length and width remain unchanged after the panel has been deflected. Therefore, in addition to the bending stress, there will be a direct tensile or membrane stress set up in the plane of the plywood, and the total stress in any ply will be the algebraic sum of the bending stress and direct stress in that ply. The maximum total stress will occur in the extreme fiber of the

outermost ply having its grain direction perpendicular to the plane of the section upon which the moment was taken; the bending stress being calculated from formula (2:67) and the direct stress from section 2.601 after first determining the average direct stress across the section from the formula:

$$f_{t(av.)} = 2.55 E_a \left(\frac{w_o}{a} \right)^2 \quad (\text{long narrow panels only}) \quad (2:90)$$

(b) Uniform load—all edges clamped.

The load-deflection relation, formula (2:88), will also apply to this case provided K_6 and K_7 from table 2-15 are substituted for K_4 and K_5 , respectively. The maximum total stress may also be determined as outlined in (a) above, provided λ_2 from figure 2-46 (c) is substituted for λ_1 in formula (2:89).

Table 2-15. Values of constants in the approximate deflection formulas for plywood panels under normal loads¹

Panel construction ²	Uniform load all edges simply supported			Uniform load all edges clamped			
	(b/a)	K_4	K_5	(b/a)	K_6	K_7	
3 ply, $\theta=0^\circ$	1.0	(see $\theta=90^\circ$)	(see $\theta=90^\circ$)	1.0	(see $\theta=90^\circ$)	(see $\theta=90^\circ$)	
	1.5	1.7	5.9	2.0	3.6	6.0	
	2.0	.9	4.7	>3.0	2.5	7.0	
	>3.0	.5	4.7				
	$\theta=90^\circ$	>1.0	6.3	13.3	1.0	33.3	27.9
				>2.0	32.0	19.2	
5 ply, $\theta=0^\circ$	1.0	(see $\theta=90^\circ$)	(see $\theta=90^\circ$)	1.0	(see $\theta=90^\circ$)	(see $\theta=90^\circ$)	
	1.5	2.4	6.5	2.0	8.3	8.2	
	>2.0	1.5	6.0	>3.0	7.9	9.4	
	$\theta=90^\circ$	1.0	6.2	12.3	1.0	28.7	17.7
		>1.5	5.0	10.0	>2.0	26.5	15.5

¹ The values given in this table are for spruce plywood, all plies of equal thickness, but they may also be considered applicable to plywood of other species and of the same constructions. For plywood made of more than five plies or of unequal ply thickness, the above table may be used as a rough guide in arbitrarily selecting values of these constants.

² θ is the angle between the face grain direction and side b of the panel.

2.77. STIFFENED FLAT PLYWOOD PANELS.

2.771. The stiffness of a stiffener affixed to a plywood panel (ref. 2.71). When a stiffener is affixed to a panel the neutral surface of the panel moves toward the stiffener as illustrated in figure 2-47. The amount of this movement is given by the equation:

$$Z_n = \frac{1}{2} \frac{t+d}{2at^4 \sqrt{E_a^3 E_b} + 1 + \frac{E_a t}{c \pi h E_s a d} + \frac{E_a t}{E_b d}} \quad (2:91)$$

in which

$$\alpha = \sqrt{\psi^2 + \sqrt{\psi^2 - 1}}$$

$$\psi = \frac{1}{2} \sqrt{E_y E_x \left(\frac{1}{G_{xz}} - \frac{2\mu_{xz}}{E_x} \right)}$$

$c=1$ if the edge of length b is simply supported

$c=2$ if the edge of length b is clamped

E_s = modulus of elasticity of the stiffener in the direction of its length

The stiffness in the neighborhood of the stiffener added to the plate by the presence of the stiffener is approximately:

$$(EI)_s = \frac{hdE_s}{12} [d^2 + 3(t+d-2Z_n)^2] + thE_s Z_n^2 \quad (2:92)$$

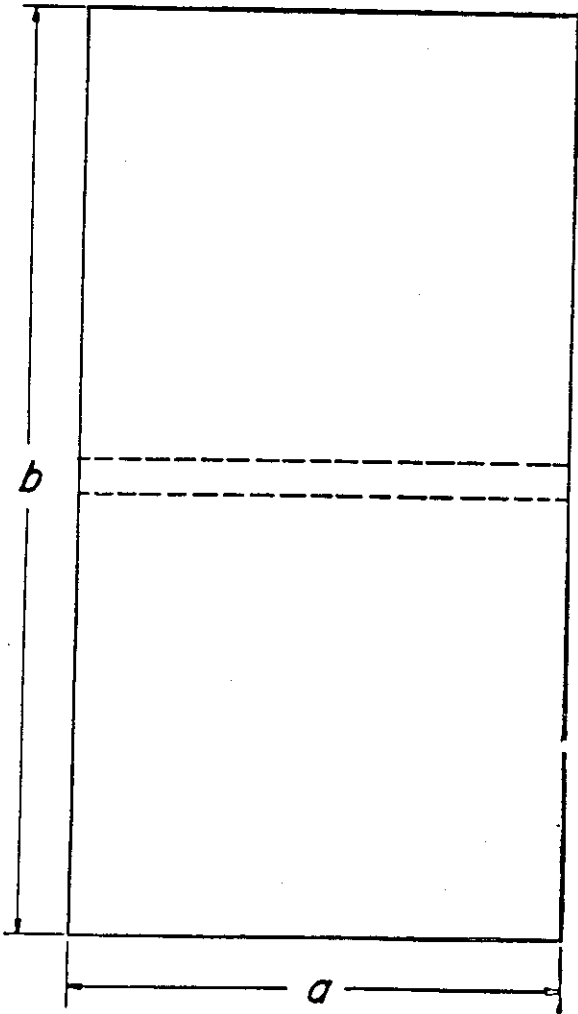

2.772. A single stiffener bisecting a panel. If the stiffener is sufficiently stiff it will substantially divide the panel into two identical panels that can be designed according to the methods of sections 2.71 and 2.72. The minimum stiffness of the stiffener that will accomplish this purpose is defined in the following sections.

2.7721. Stiffened panel subjected to edgewise compression, stiffener perpendicular to the direction of the stress and parallel to side a ($\beta=0^\circ$ or 90°) (ref. 2-30).

$$(EI)_{scr} = \frac{t a^4}{11b} (F_{crm} - F_{crp}) \quad (2:93)$$

in which $(EI)_{scr}$ is the critical value of $(EI)_s$ as determined by equation (2:92); F_{crp} and F_{crm} are the critical buckling stresses of the panel, considered to be unstiffened and adequately stiffened

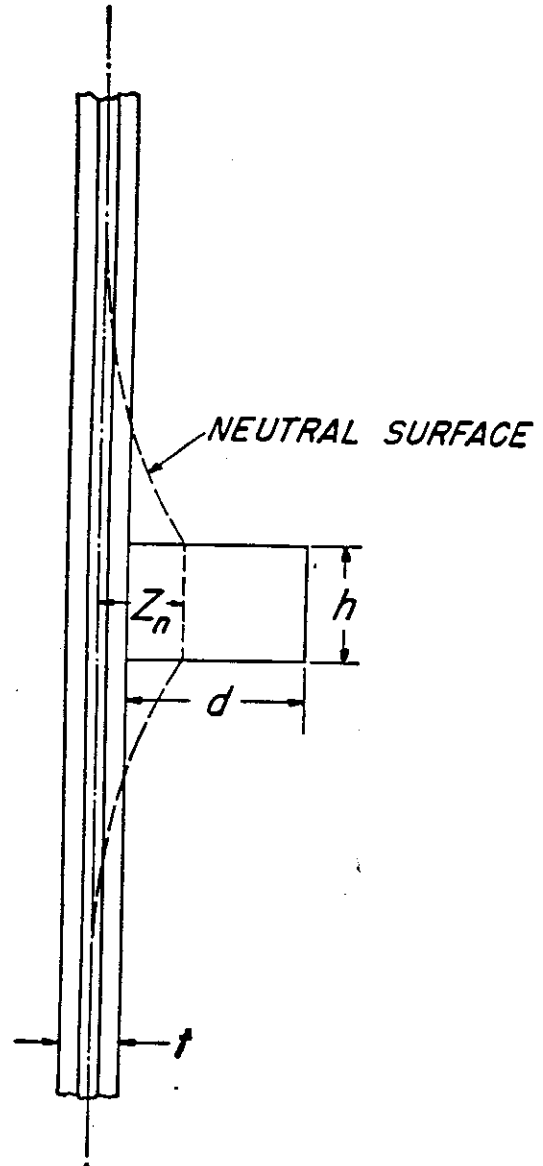

Figure 2-47. Nomenclature for equations (2:91) and (2:92).

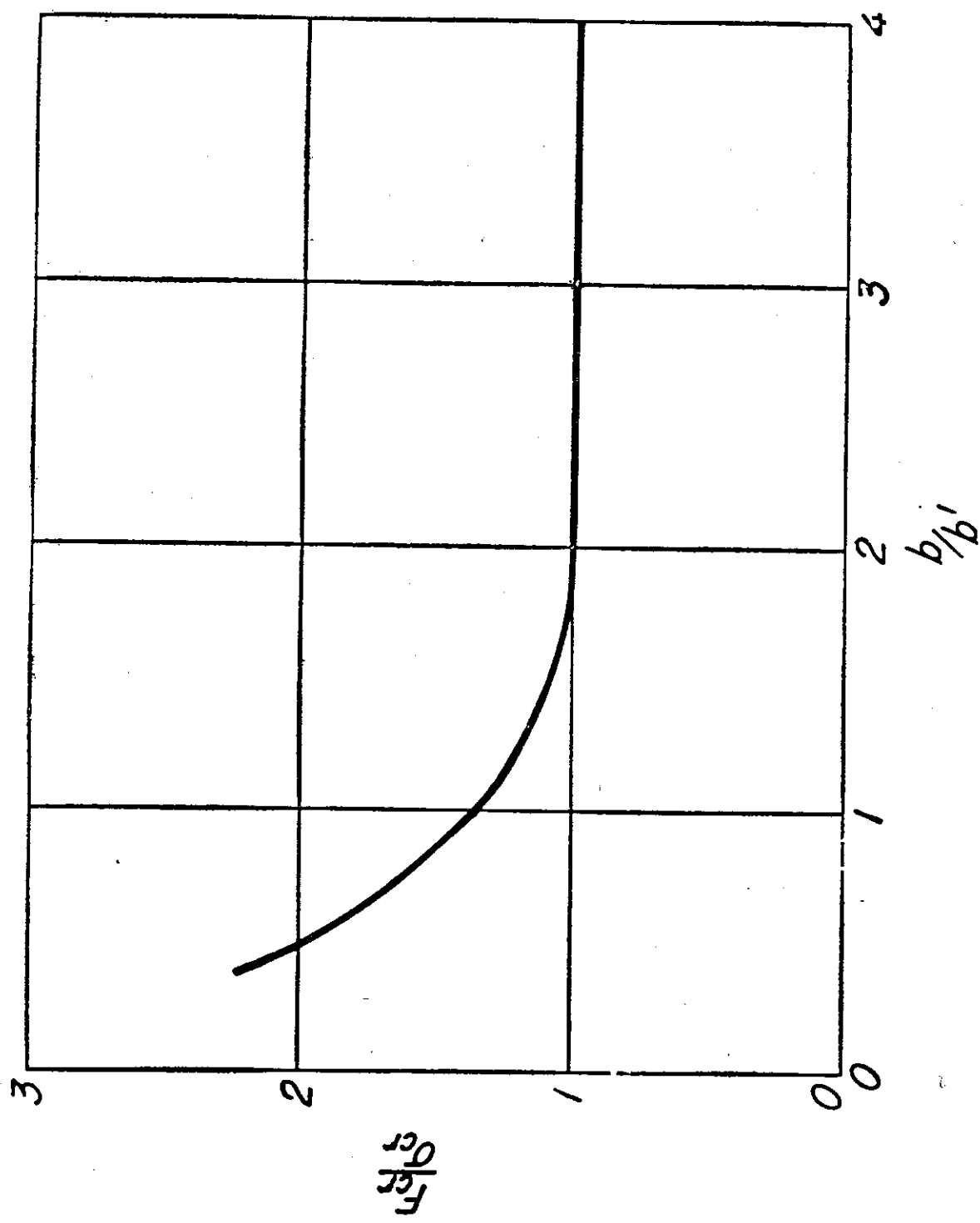

Figure 2-48. Curve for the determination of values of σ_{cr} and σ_{erm} from values of F_{cr} and F_{erm} .

respectively, obtained by means of the method of section 2.712, Case I.

2.7722. *Stiffened panel subjected to edgewise compression, stiffener perpendicular to the direction of the stress ($\beta=45^\circ$).* The stiffness in the neighborhood of the stiffener added to the plate by the stiffener is assumed to be the stiffness of the stiffener alone

$$(EI)_s = \frac{1}{12} E_s h d^3 \quad (2:94)$$

and the critical stiffness of the stiffener is approximately

$$(EI)_{scr} = \frac{t a^4}{40 b} (\sigma_{crm} - \sigma_{crp}) \quad (2:95)$$

in which

a = the dimension of the panel perpendicular to the direction of the stress

b = the dimension of the panel parallel to the direction of the stress

and in which the values of σ_{crp} and σ_{crm} are obtained from the critical buckling stresses of the panel, considered to be unstiffened and adequately stiffened respectively, by means of figure 2-48 and the method of section 2.715 for panels with edges simply supported and having their face grain at 45° to their edges.

2.7723. *Stiffened panel subjected to edgewise compression, stiffener parallel to the direction of the stress and to side b ($\beta=0^\circ$ or 90°).*

$$(EI)_{scr} = \frac{t a b^2}{10(n+1)^2} \left[F_{crm} \left(1 + \frac{2dh E_s}{a t E_b} \right) - F_{crp} \right] \quad (2:96)$$

in which $(EI)_{scr}$ is the critical value of $(EI)_s$ as determined by equation (2:92); F_{crp} and F_{crm} are the critical buckling stresses of the panel, considered to be unstiffened and adequately stiffened respectively, obtained by the means of the method of section 2.712, Case I, and n is the number of half-waves that occur in the unstiffened panel. It may be noted that the dimensions of the stiffener, d and h , appear in equation (2:96) as well as in equations (2:91) and (2:92) and, therefore, it is necessary to estimate the values of these dimensions and verify the estimate by use of equation (2:96).

The compressive stress in the stiffener associated with the critical stress of the panel is:

$$f_{scr} = \frac{E_s}{E_b} F_{crm} \quad (2:97)$$

The load carried by the panel and the stiffener at the critical stress of the panel is:

$$P_{cr} = F_{crm} \left[at + \frac{E_s}{E_b} dh \right] \quad (2:98)$$

The ultimate load of the stiffened panel cannot be greater than the sum of the ultimate loads of the two half panels according to section 2.722 plus the ultimate load of the stiffener considered as a short column. The reduction of this sum in terms of the a/a_o of one of the half panels is given by figure 2-49 (ref. 2-30).

2.7724. *Stiffened panel subjected to edgewise compression, stiffener parallel to the direction of the stress ($\beta=45^\circ$).* The stiffness in the neighborhood of the stiffener added to the panel by the stiffener is assumed to be the stiffness of the stiffener alone and is given by formula (2:94). The critical stiffness of the stiffener is:

$$(EI)_{scr} = \frac{1}{66} t a b^2 (F_{crm} - F_{crp}) \quad (2:99)$$

in which $(EI)_{scr}$ is the critical value of $(EI)_s$ as determined by equation (2:94); F_{crm} and F_{crp} are the critical buckling stresses of the panel, considered to be adequately stiffened and unstiffened, respectively, obtained by means of the method of section 2.715; and a and b are the dimensions of the panel perpendicular and parallel to the direction of the stress, respectively (ref. 2-70).

2.7725. *Stiffened panel subjected to edgewise shear. Stiffener parallel to edges (or ends) of panel and $\beta=0^\circ$ or 90° .*

$$(EI)_{scr} = 8 \frac{E_s h t^3 L^4}{K_1 a^4} \quad (2:100)$$

in which

$(EI)_{scr}$ = the critical value of $(EI)_s$ as determined by equation (2:92)

L = length of stiffener

a = width of panel (independent of the direction of the stiffener)

K_1 is determined by means of figure 2-46

The critical stress of the stiffened panel is computed by means of section 2.713 equation (2:77) applied to one half of the panel as divided by the stiffener, provided that $(EI)_s$ is equal to or greater than $(EI)_{scr}$.

2.773. *A plywood panel stiffened with a multiplicity of closely spaced stiffeners parallel to one of its edges ($\beta=0^\circ$ or 90°).* If the spacing of the stiffeners is not too great the formulas for plywood

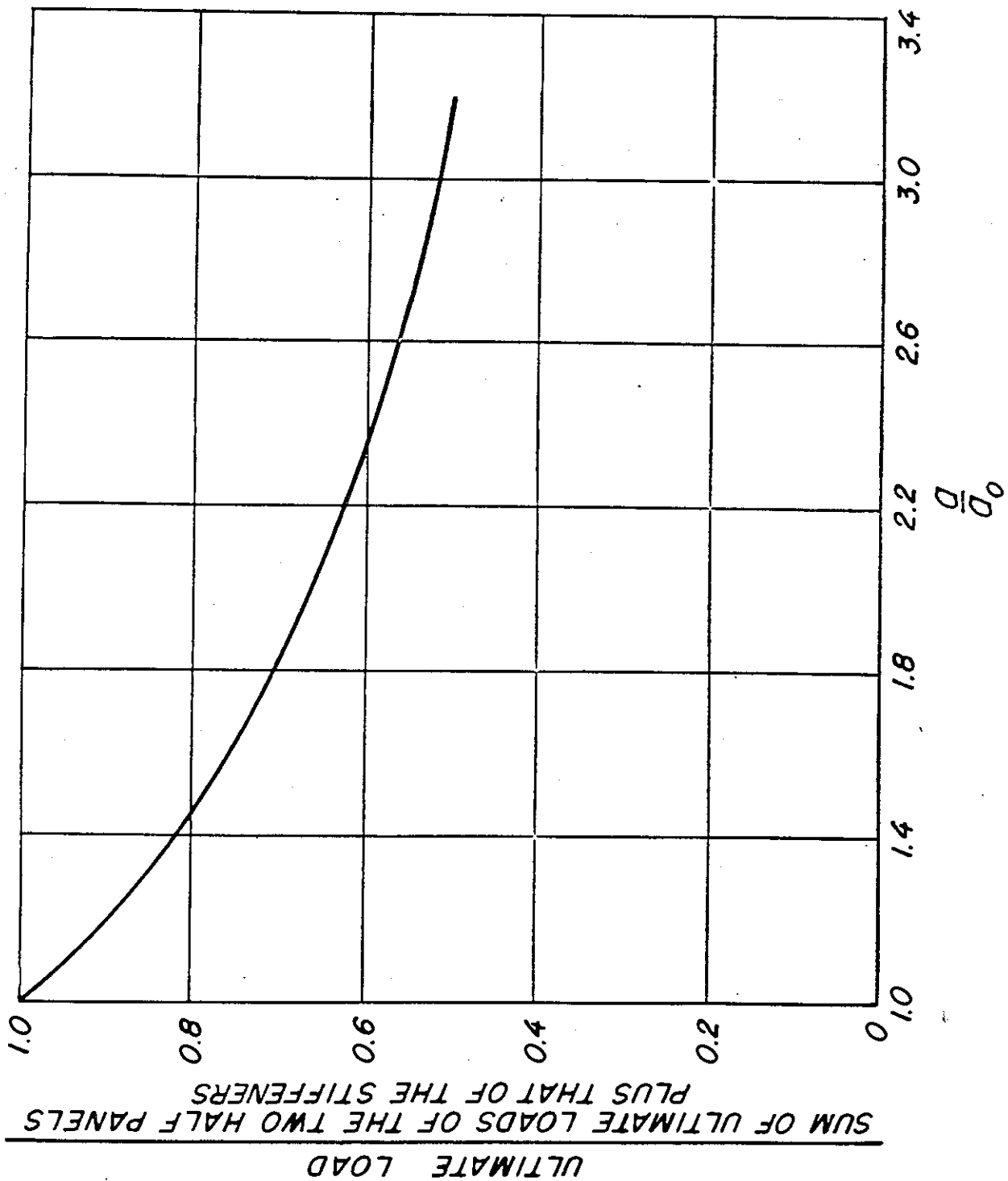

Figure 2-49. Curve for computation of ultimate load on a panel having a vertical stiffener.

of section 2.71 can be applied to such panels. It is convenient to employ formulas for the load per inch of length of the edge of the stiffened panel rather than formulas for stress, thus

$$P_{scr} = F_{scr} t_e$$

where t_e is the effective thickness of the stiffened panel, which it will not be necessary to compute. The following nomenclature is convenient.

$$D_w = \frac{E_{fw} t^3}{12 \lambda_f} \text{ or } \frac{E_{fx} t^3}{12 \lambda_f} \left\{ \begin{array}{l} \text{for stiffeners parallel} \\ \text{or perpendicular} \\ \text{to the direction of} \\ \text{the face grain of} \\ \text{the panel, respec-} \\ \text{tively.} \end{array} \right.$$

$$D_x = \frac{E_{fx} t^3}{12 \lambda_f} \text{ or } \frac{E_{fw} t^3}{12 \lambda_f}$$

$$D_{wx} = \frac{G_{fwt} t^3}{12}$$

D_{wc} , D_{xc} , and D_{wxc} are computed similarly to the above except that the stiffener is considered as an extra ply of the plywood. The location of the neutral axis is taken into account as described in section 2.52.

D_{we} , D_{xe} , and D_{wxe} are effective values that apply to the stiffened panel.

The subscripts w and x applied to D denote directions parallel and perpendicular, respectively, to the direction of the stiffeners, and subscripts 1 and 2 denote directions parallel and perpendicular, respectively, to the direction of the stress for panels subjected to compression and to the direction of side b for panels subjected to shear.

Equations (2:72) and (2:77) become

$$P_{scr} = 12 H_c \sqrt{D_{we} D_{xe}} \frac{1}{a^2} \quad (2:101)$$

$$P_{scr} = 12 H_s [D_{1e}^3 D_{2e}]^{1/4} \frac{1}{a^2} \quad (2:102)$$

in which

$$k = \frac{D_{we} \mu_{fzwe} + 2 D_{wxe}}{\sqrt{D_w D_x}}$$

$$r = \frac{b}{a} \left(\frac{D_{1e}}{D_{2e}} \right)^{1/4}$$

2.7731. *Determination of D_{we} .* The stiffeners being closely spaced, the usual engineering formula that takes into account the location of the neutral axis, can be employed.

$$D_{we} = D_w + \frac{nhd}{12g} E_s \left[d^2 + \frac{3(t+d)^2}{\frac{nhd E_s}{g E_g t} + 1} \right] \quad (2:103)$$

in which

g = the width of the panel across the stiffeners and is equal to a or b as required

n = the number of stiffeners

E_s = modulus of elasticity of the stiffeners in the direction of their length.

2.7732. *Determination of D_{xe} .* When a panel is bent across the stiffeners, the variation of the stiffness at the stiffeners and between the stiffeners, and the presence of a sharp kink at the edges of the stiffeners due to stress concentrations, are taken into account.

$$\frac{D_x}{D_{xe}} = \frac{6}{19} \left[1 - \left(1 - \frac{h}{s} \right)^2 \right] \left[1 - \frac{D_x^2}{D_{xc}^2} \right] - \frac{h}{s} \left[1 - \frac{D_x}{D_{xc}} + 1 \right] \quad (2:104)$$

in which

s = distance center to center of two adjacent stiffeners.

2.7733. *Determination of D_{wxe} .*

$$D_{wxe} = \frac{1}{g} \{ [g - nh] D_{wx} + n [h - \epsilon(t+d)] D_{wxc} \} \quad (2:105)$$

in which g is the width of the panel across the stiffeners, n is the number of stiffeners, and ϵ is determined from figure 2-50 and 2-51.

2.7734. *Determination of μ_{fzwe} .*

$$\mu_{fzwe} = \frac{\sqrt{\mu_{fzx} \mu_{fzw} D_{we} D_{xe}}}{D_{we}} \quad (2:106)$$

in which the values of μ_{fzx} and μ_{fzw} are taken from equations (2:32) and (2:33) of section 2.52, assuming that the stiffener is an added ply of the plywood.

2.774. *Stiffened plywood panels subjected to bending in the direction of the stiffeners.* The maximum bending stress in stiffened plywood panels can be calculated from the following formula, when the face grain direction is 0° or 90° to the direction of the span:

$$f_b = \frac{M E_L c'}{D_{we}} \quad (2:107)$$

where:

c' = distance from the neutral axis of the composite section to the extreme longitudinal fiber

E_L is taken for the species of the outermost longitudinal fiber.

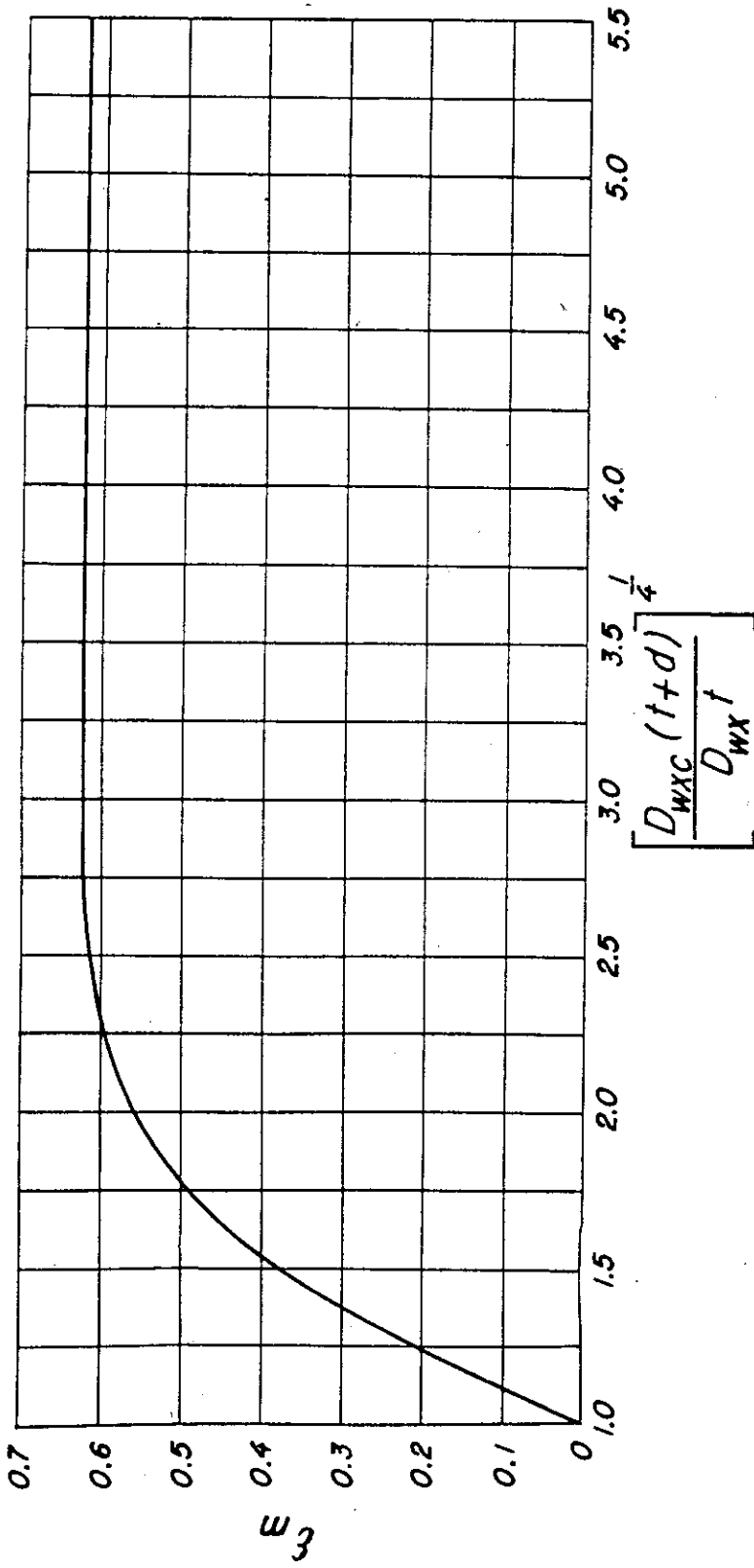

Figure 2-50. Curve for the determination of the values of ϵ_m .

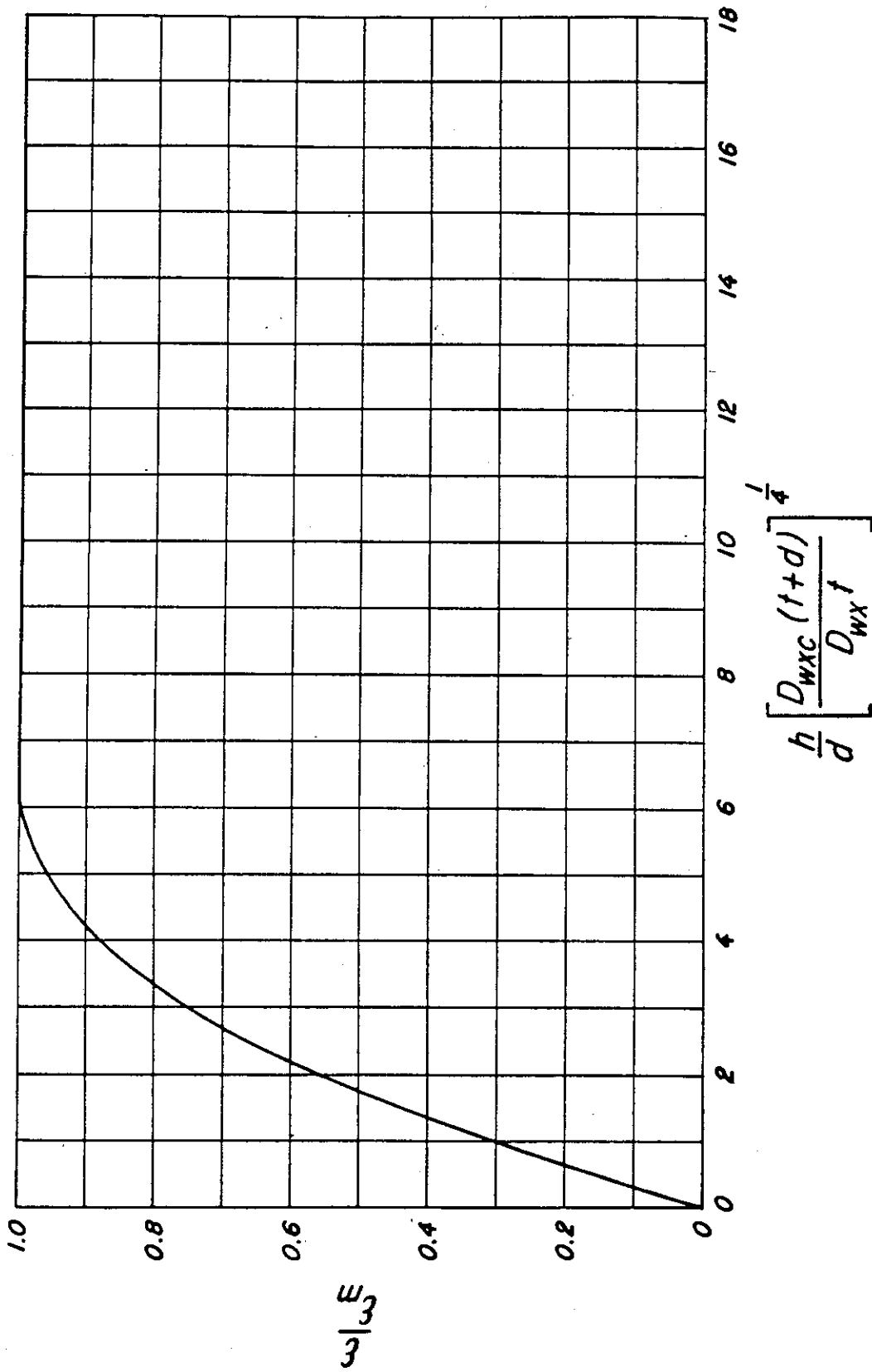

Figure 2-51. Curve for the determination of the values of ϵ/ϵ_0

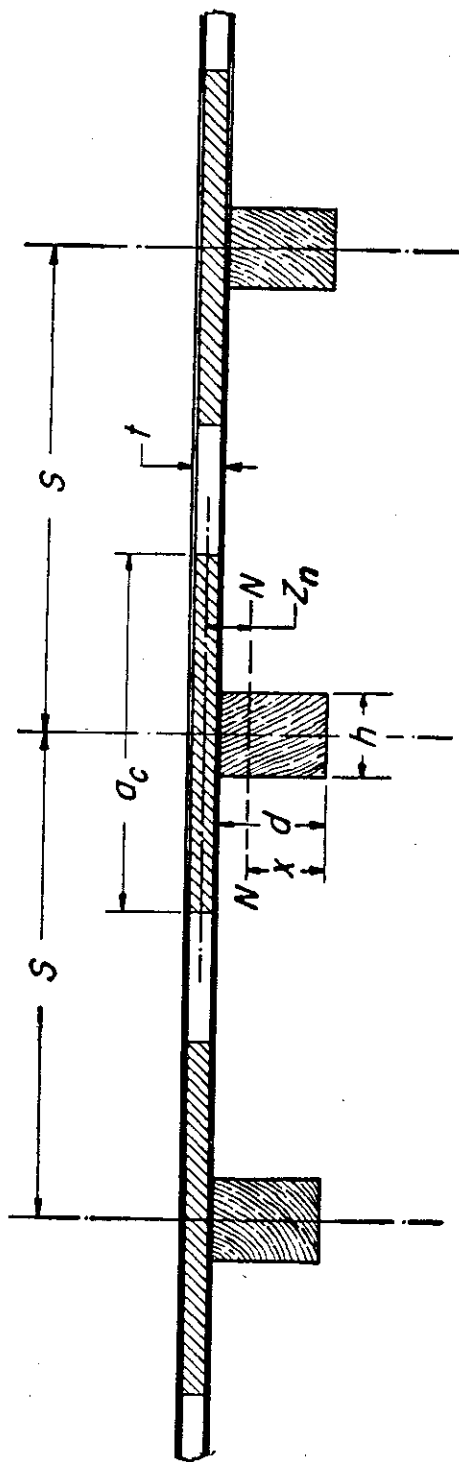

Figure 2-52. Cross section of panel stiffened with multiple stiffeners.

This maximum bending stress should not exceed the modulus of rupture of the material in which the maximum stress exists. If the stiffener is of an I or box section, the modulus of rupture must be corrected by a form factor as follows: When the load is applied so that the outer flange of the stiffener will fail in compression, the proper form factor to use is that for a beam having the same flange dimensions as the outer flange of the stiffener, and the same web thickness as the stiffener, but of a depth equal to $2x$. If the load is applied so that the panel will fail in compression, the proper form factor to use is that of a beam having flange dimensions equal to that of the effective sheet plus the flange of the stiffener adjacent to the panel, and a web thickness equal to that of the stiffener but a depth of $2(d+t-x)$. In either case no form factor need be used if the neutral axis lies within the compression flange, where x is the distance from the neutral axis to the stiffener face away from the panel as shown in figure 2-52.

The effective width of the panel for stresses below the proportional limit is:

$$a_e = \frac{dhE_s(t+d-2Z_n)}{2tE_bZ_n} \quad (2:108)$$

in which Z_n is obtained from equation (2:91) and b is in the direction of the stiffeners.

If the spacing of the stiffener (s in fig. 2-52) is less than a_e , the value of D_{we} is obtained from equation (2:103) and

$$Z_n = \frac{1}{2} \frac{t+d}{\frac{ts}{dh} \frac{E_b}{E_s} + 1} \quad (2:109)$$

If this is not the case, then

$$D_{we} = D_w + \frac{1}{a_e} \frac{hd^3}{12} E_s + tE_bZ_n^2 + \frac{dh}{4a_e} E_s(t+d-2Z_n)^2 \quad (2:110)$$

in which Z_n is obtained from equation (2:91), a_e from equation (2:108), and b is in the direction of the stiffeners.

For stiffened panels having the face grain direction 45° to the length of the stiffeners, the plywood is neglected in the computations and the stiffeners designed to carry the total load.

2.775. *Modes of failure in stiffened panels.* Modes of failure other than failure of the panel or the stiffeners are not considered here.

A possible mode of failure, which has been investigated for only one particular type of con-

struction, is the premature separation of the plywood panel from its stiffeners occurring when the forces required to restrain the edges of the buckled panels become too great for the strength of the plywood or its attachment to the stiffeners.

Since no criteria suitable for general application are available for predicting the critical modes of failure, it is recommended that typical panels of each particular type of construction be tested.

2.8. Curved Plywood Panels

2.81. **STRENGTH IN COMPRESSION OR SHEAR; OR COMBINED COMPRESSION (OR TENSION) AND SHEAR.** When failure by buckling does not occur, the ultimate strength of curved plywood panels subjected to compression or shear, or combined compression (or tension) and shear may be obtained by the method given in section 2.613. This method is applicable when the face grain direction is at any angle.

2.82. **CIRCULAR THIN-WALLED PLYWOOD CYLINDERS.**

2.821. *Axial compression.*

2.8211. *Compression with face grain parallel or perpendicular to the axis of the cylinder.* The theoretical buckling stress for a long cylinder (to be modified for design as described later in the section) is given by the formula:

$$F_{ccr} = K_\sigma [E_{fw} + E_{fx}] \frac{t}{r} \quad (2:111)$$

where

E_L is for the species of the face plies

t = thickness of plywood

r = radius of cylinder

K_σ is a buckling constant that is a function of

$\frac{E_1}{E_1 + E_2}$ and is determined from figure

2-53. In using figure 2-53, E_1 is the flexural stiffness of the plywood in the direction parallel to the longitudinal axis of the cylinder. E_1 is equal to E_{fw} when the face grain is longitudinal and is equal to E_{fx} when the face grain is circumferential. E_2 is the flexural stiffness of the plywood in the circumferential direction. $E_1 + E_2$ is equal to $E_{fw} + E_{fx}$.

Because of the steepness of the curve for K_σ at the extreme right and left portions, it appears advisable to avoid, when possible, the use of types of plywood for which the ratio $\frac{E_1}{E_1 + E_2}$ is small or nearly equal to unity.

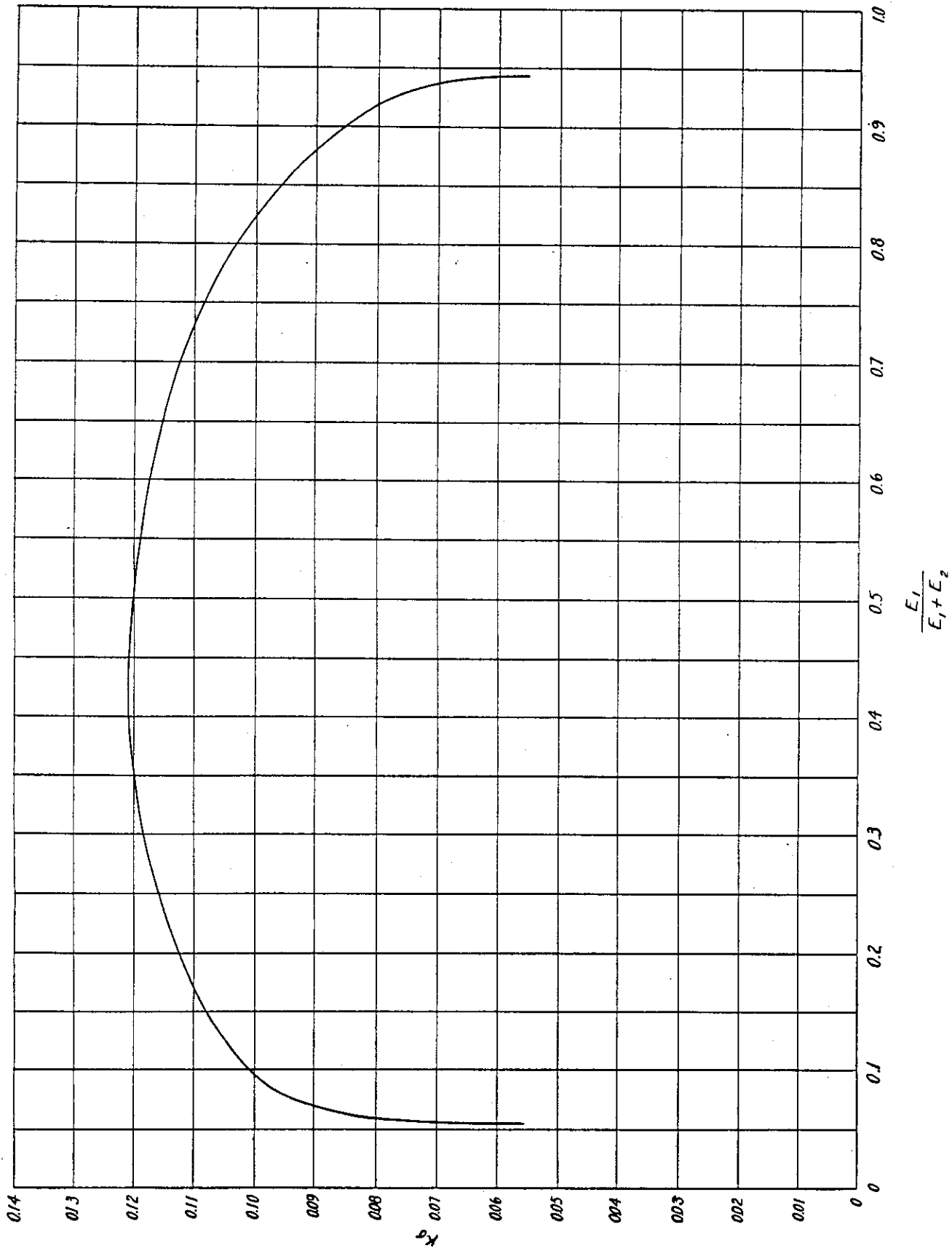

Figure 2-53. Theoretical curve for long, thin plywood cylinders in axial compression.

For use in design, the theoretical buckling stress must be modified as the proportional-limit stress is approached. This is accomplished by the use of figure 2-54. The proportional-limit stress used with this chart is the compressive proportional limit for the plywood in the direction of the cylinder axis and is determined from table 2-13 or from section 2.600. $F_{cp} = F_{cpw}$ when the face grain is longitudinal. $F_{cp} = F_{cpx}$ when the face grain is circumferential. The chart is entered along the abscissa with the ratio $F_{scr}(\text{theoretical})/F_{cp}$. The design buckling stress, F_{scr} , is then obtained by multiplying the ordinate by F_{cp} .

Limited amounts of double curvature have negligible effect on buckling loads.

2.8212. *Compression with 45° face grain.* When the face grain is at an angle of 45° to the cylinder axis, the theoretical buckling stress may be taken as the average of the theoretical buckling stresses obtained by assuming the face grain direction to be: (1) parallel to the cylinder axis, (2) circumferential. In using figure 2-54, however, to obtain the design buckling stress, the proportional-limit value F_{cp} should be that for the plywood at 45° to the face grain. F_{cp45} may be taken as $0.55 F_{cu45}$, where F_{cu45} is determined by section 2.610.

2.8213. *Compression—effect of length.* If the cylinders are not long, an adjusted value by K_s , designated by K_{sa} , should be used in formula (2:111). Values of K_{sa} can be determined from figure 2-55 in which L is the length of the cylinder, and the subscripts 1 and 2 apply to the axial and circumferential directions respectively.

2.822. *Bending.* For bending, the design buckling stress determined as for compression may be increased 10 percent.

2.823. *Torsion.* The buckling stresses of thin plywood cylinders can be computed by the formula

$$F_{scr} = K_s (E_{fw} + E_{fz}) \frac{t}{r} \quad (2:112)$$

in which the value of K_s depends upon values of W , U , $\frac{E_1}{E_1 + E_2}$, and θ

$$W = \frac{1}{2} \frac{G_{fwz} + G_{wz}}{E_{fw} + E_{fz}}$$

$$U = \frac{L^2}{rt}$$

θ = angle between face grain and generator of cylinder (fig. 2-56)

Values of K_s , for different values of W , U , and θ are given in figures 2-57, 2-58, and 2-59. The nomenclature is illustrated in figure 2-56. (Ref. 2-93)

2.824. *Combined torsion and bending.* Cases of combined loading can be checked by the following interaction formula:

$$\left(\frac{f_{st}}{F_{stcr}}\right)^{4/3} + \left(\frac{f_b}{F_{bcr}}\right)^{4/3} = 1.0 \quad (2:113)$$

where:

f_{st} = applied torsional shear stress

f_b = applied bending stress

F_{stcr} = pure torsion design buckling stress

F_{bcr} = pure bending design buckling stress

2.83. CURVED PANELS.

2.831. *Axial compression.* The buckling stress is that of a complete cylinder, of which the curved panel can be considered to be a part, of a length equal to the axial dimension of the panel. It can be obtained by use of formula (2:111) corrected for length by the method of section 2.8213.

If the curved panel is very accurately made, higher values may be obtained by test but cannot be counted upon in design.

2.832. *Shear.* An approximation of the buckling stress is obtained by adding the buckling stress of the panel considered to be flat to that of the cylinder of which the panel can be considered to be a part. Thus the buckling stress is given approximately by (ref. 2-40)

$$F_{scr} = H_s \frac{(E_1^3 E_2)^{1/4}}{3\lambda_f} \left(\frac{t}{a}\right)^2 + K_s (E_{fw} + E_{fz}) \frac{t}{r} \quad (2:114)$$

or

$$F_{scr} = [E_{fw} + E_{fz}] \left[K_s \frac{t^2}{a^2} + K_s \frac{t}{r} \right] \quad (2:115)$$

in which formula (2:114) comes from (2:77) and (2:112); formula (2:115) comes from (2:80) and (2:112).

2.84. LONGITUDINALLY STIFFENED CYLINDERS. A multiplicity of evenly spaced identical stiffeners attached to the inner surface of the cylinders.

2.841. *Stresses when buckling does not occur.* The strengths can be computed by use of sections 2.610 to 2.614.

2.8411. *Axial compression (or tension).* The compressive stress in the plywood is:

$$f_c = \frac{PE_a}{nhdE_s + 2\pi rtE_a} \quad (2:116)$$

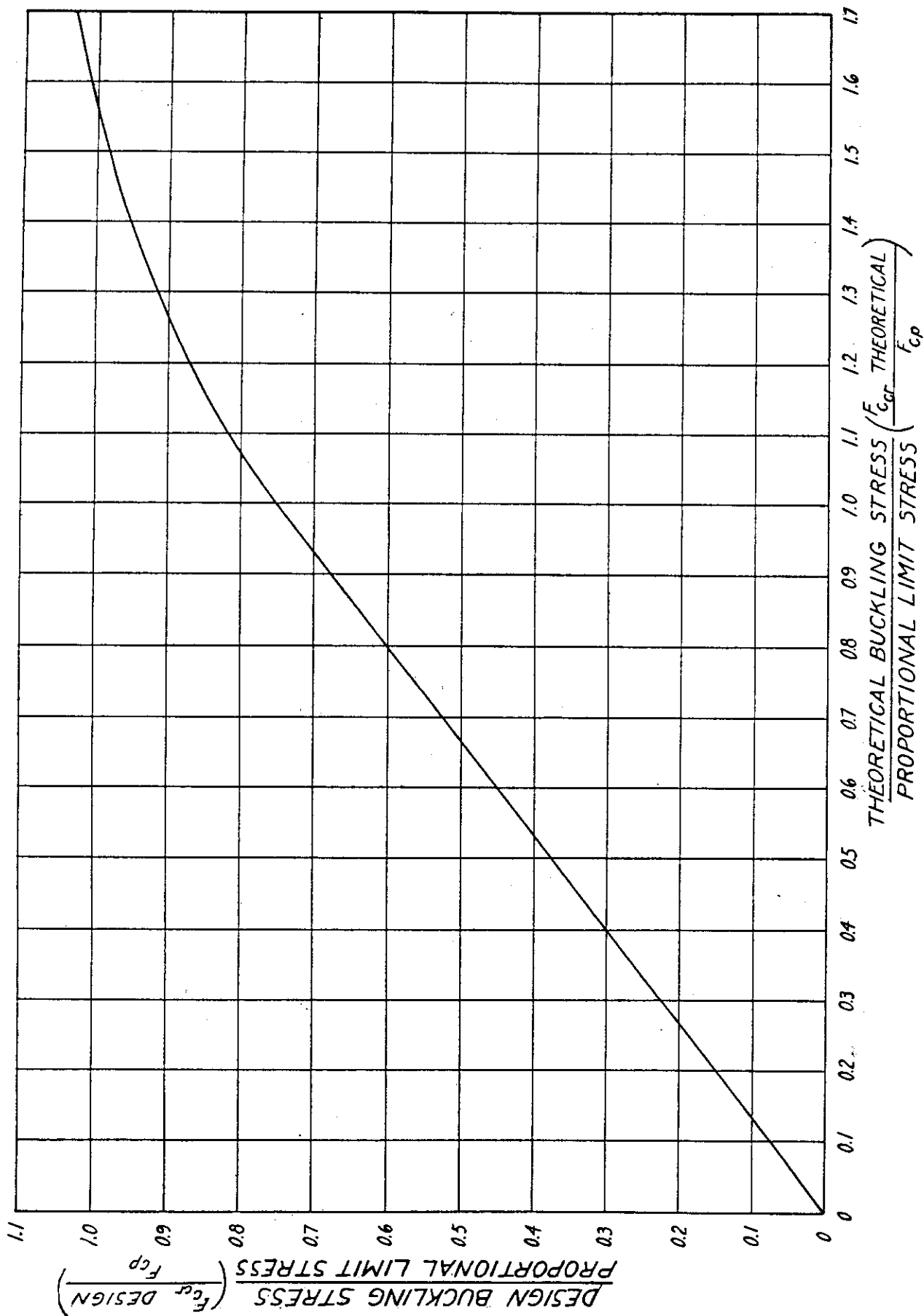

Figure 2-54. Design curve for long, thin-walled plywood cylinders.

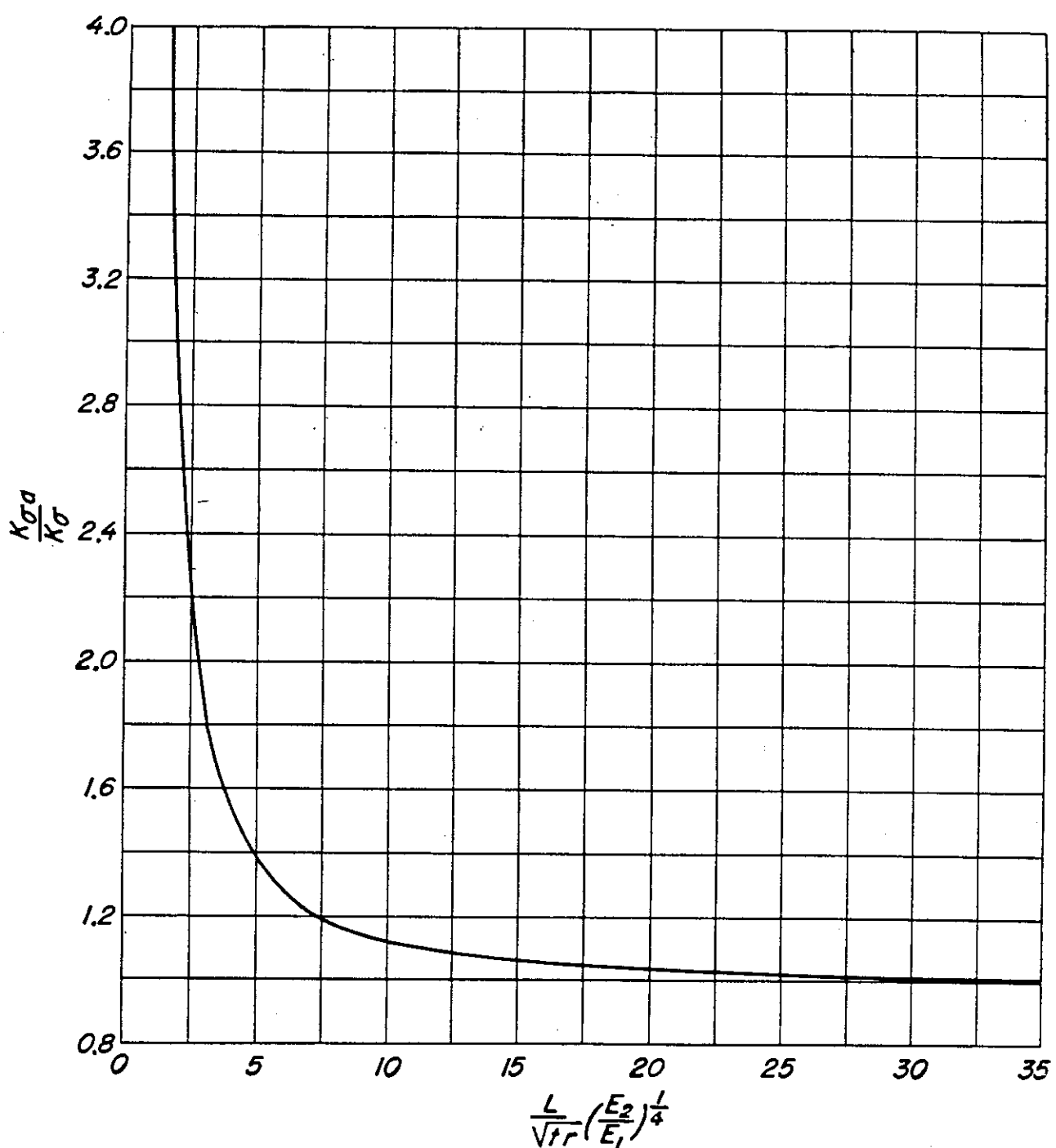

Figure 2-55. Curve showing length effect of cylinders subjected to axial compression.

and that in the stiffeners is

$$f_c = \frac{PE_s}{nhdE_s + 2\pi rtE_a} \quad (2:117)$$

in which P is the total load on the stiffened cylinder, E_a and E_s apply to the plywood and the stiffeners, respectively, in the direction of the axis of the cylinder, r is the mean radius of the plywood cylinder, n is the number of the stiffeners, h and

d are the cross-sectional dimensions of an individual stiffener, and t is the thickness of the plywood.

2.8412. *Shear stress due to torsion.* The shear stress in the plywood is:

$$f_s = \frac{2G_{ab}Tr_3}{nhG_s \frac{r_2^4 - r_1^4}{r_2 + r_1} + \pi G_{ab}(r_3^4 - r_2^4)} \quad (2:118)$$

and that in the stiffener is:

$$f_s = \frac{2G_s T r_2}{nhG_s \frac{r_2^4 - r_1^4}{r_2 + r_1} + \pi G_{ab}(r_3^4 - r_2^4)} \quad (2:119)$$

in which r_1 is the radius of a cylinder tangent to the inner surfaces of the stiffeners, r_2 and r_3 are the inner and outer radii of the cylinder, respectively, G_{ab} and G_s are the moduli of rigidity of the plywood and the stiffeners, respectively, with reference to longitudinal and circumferential axes, and T is the applied torque.

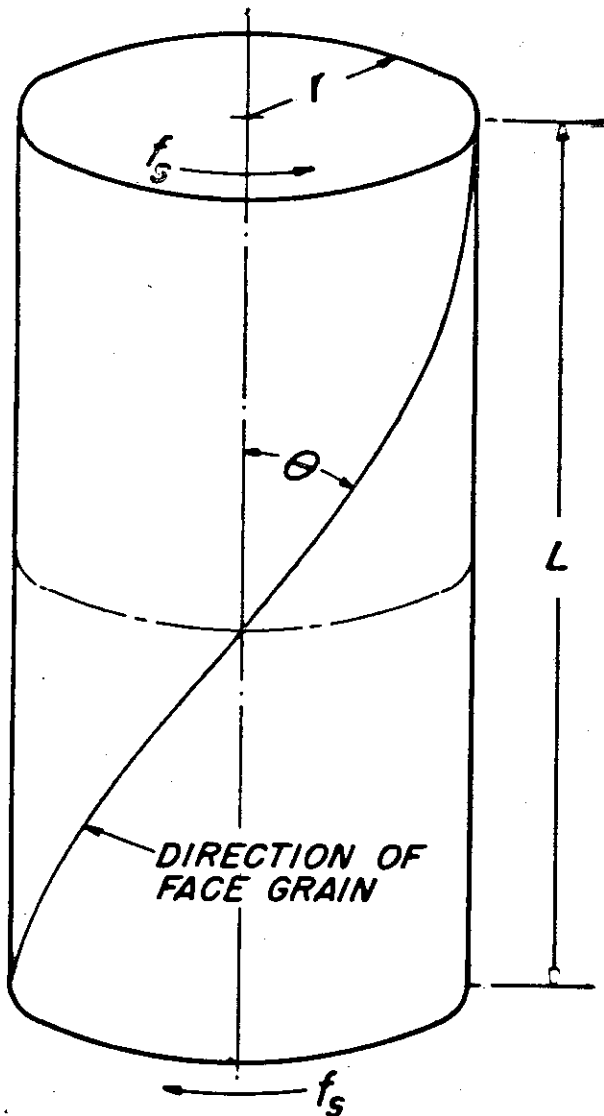

Figure 2-56. Illustration of the meaning of the symbols used for cylinders subjected to torsion.

2.842. *Buckling of stiffened cylinders.*

2.8421. *Axial compression.* In general the plywood will buckle between the stiffeners when the stress in it equals the buckling stress for the

cylinder, the effect of the stiffeners being ignored, and, therefore, formula (2:111) employed. The load at which such buckling occurs can be found by setting this stress (F_{scr} from formula 2:111) equal to f_c in formula (2:116) and solving for the load P .

Tests indicate that unless the stiffeners are quite stiff they will buckle with the cylinder and fail at the load computed in the above manner. If the stiffeners are so stiff that they do not buckle with the cylinder, the maximum load will be greater than that computed. However, no methods are available for the determination of the size stiffeners required to obtain this effect nor to compute the maximum loads that are obtained. (Ref. 2-95)

2.8422. *Torsion.* The shear buckling stress of the curved plywood shell between the stiffeners is about 85 percent of that obtained by formula (2:112) for the cylinder, neglecting the effect of the stiffeners. The torque at which buckling occurs can be found by setting this stress $0.85 \times F_{scr}$ from (2:112) equal to f_s in formula (2:118) and solving for the torque T .

Tests indicate that the maximum torque coincides with the torque at which buckles form.

2.8423. *Bending.* For bending, the design buckling stress determined as for compression may be increased 10 percent. Tests indicate that for very stiff stiffeners this percentage may be increased. (Ref. 2-96)

2.85. **STIFFENED CURVED PANELS.** A single stiffener bisecting the panel.

2.851. *Axial compression.*

2.8511. *Stiffener axial.* The critical stress in the plywood is computed according to the method of section 2.831, and the critical load of the stiffened panel can be obtained by substituting this value for f_c in equation (2:116), placing n equal to unity, and solving for P .

2.8512. *Stiffener circumferential.* The critical stress is computed according to the method of section 2.831, using the distance between the stiffener and the end of the panel as the length of the cylinder, provided that

$$(EI)_s > 0.4 F_{scr} r^2 h^2 \quad (2:120)$$

in which $(EI)_s$ is given by formula (2:84), and F_{scr} is the critical stress of the entire panel, neglecting the stiffener, computed by the method of section 2.831.

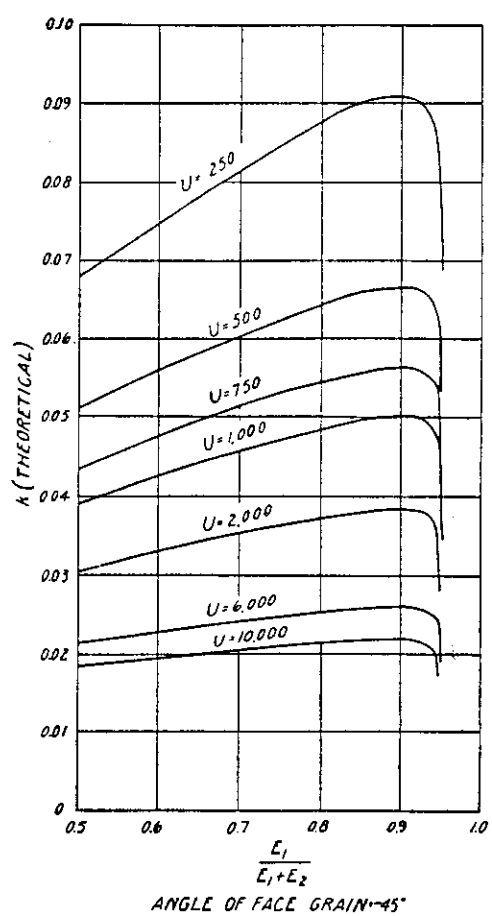
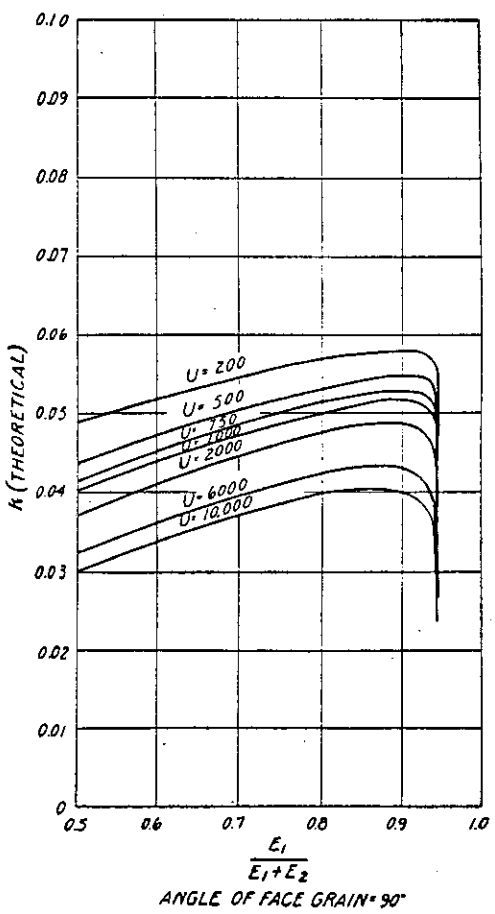
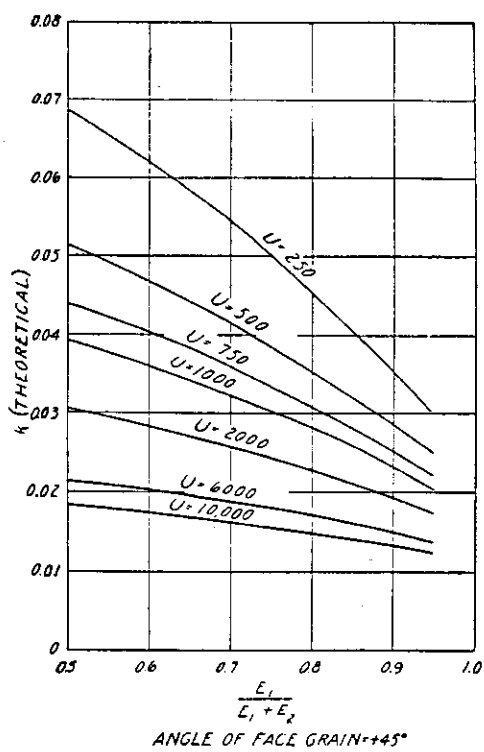
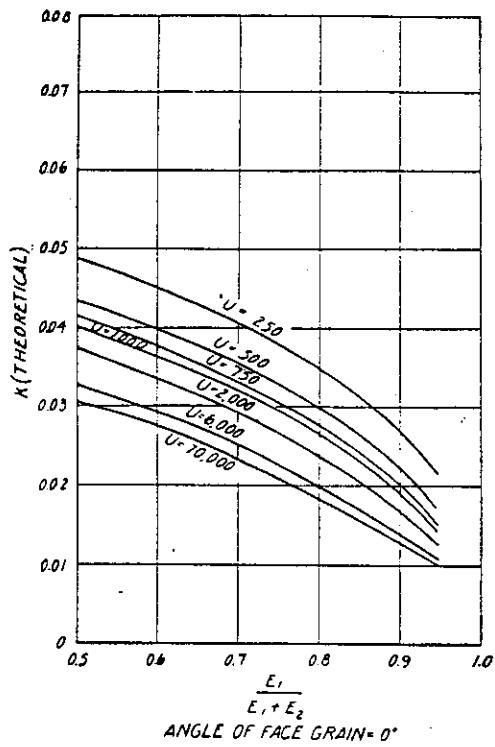

Figure 2-57. Theoretical buckling constants for thin-walled plywood cylinders in torsion, $W = 0.036$.

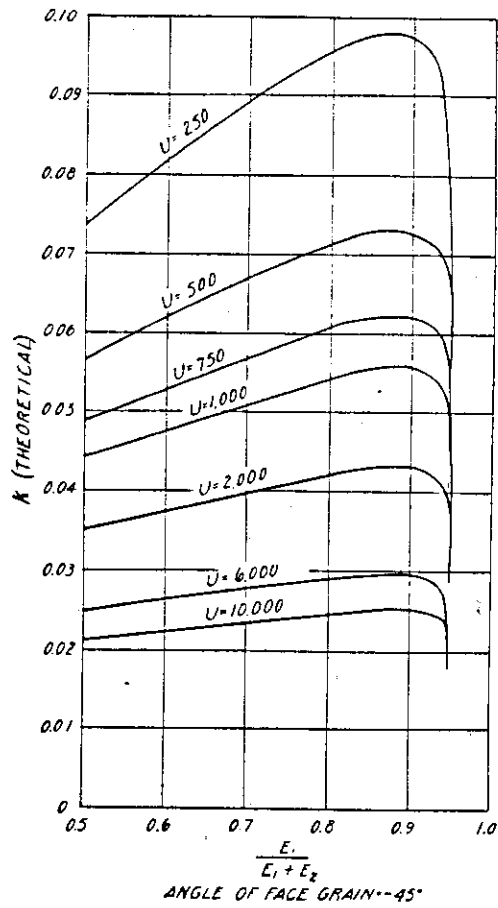
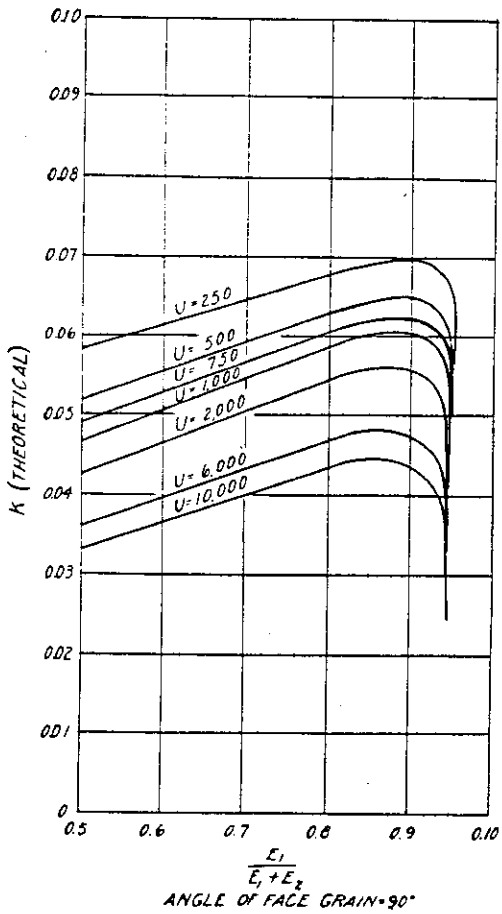
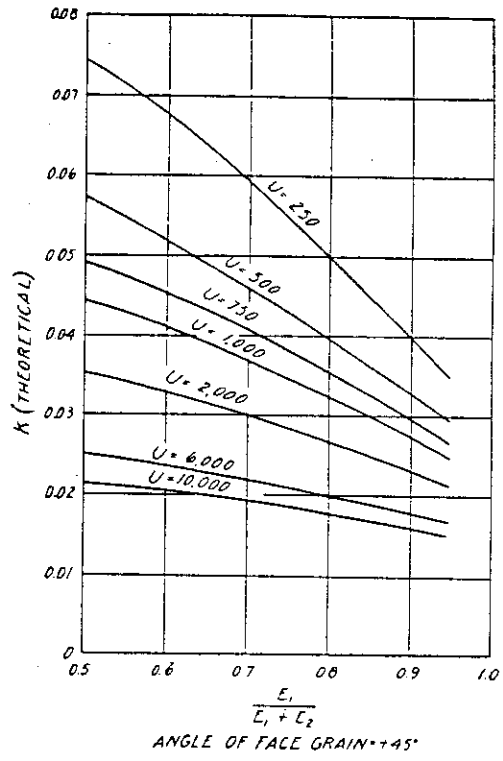
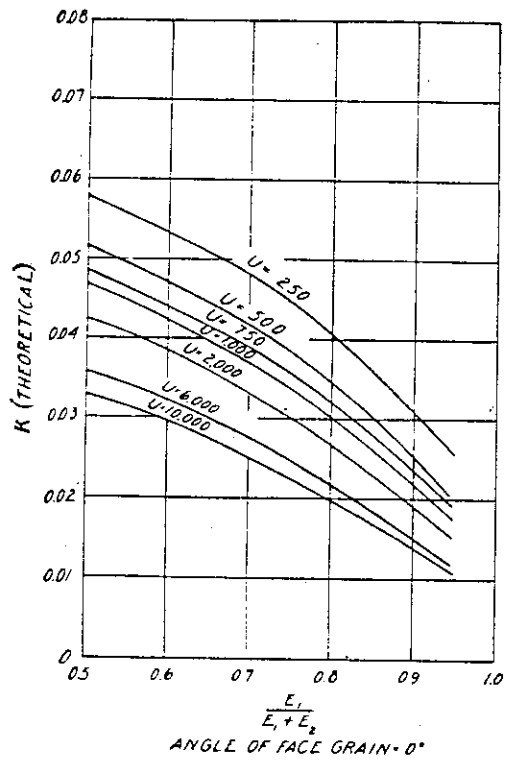

Figure 2-58. Theoretical buckling constants for thin-walled plywood cylinders in torsion, $W=0.056$.

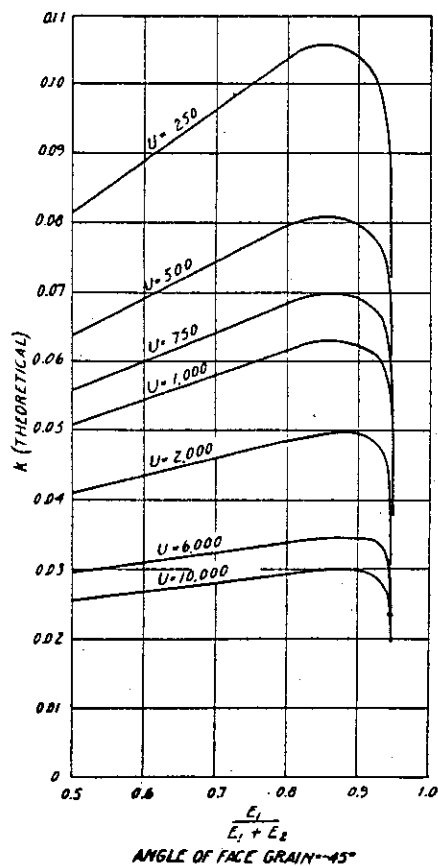
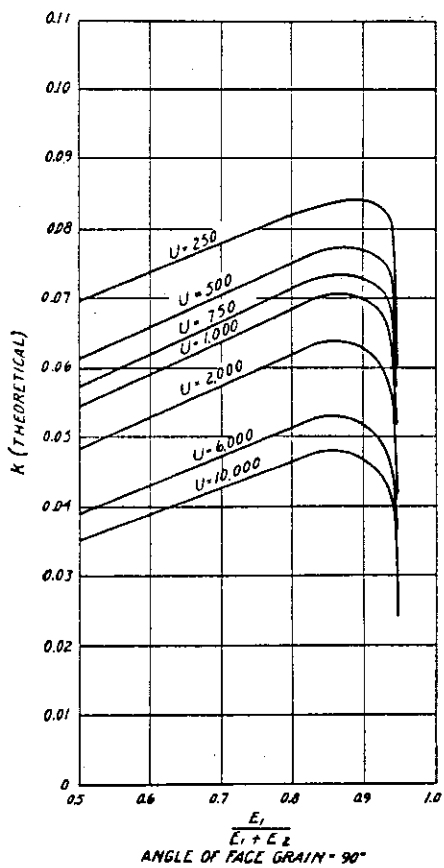
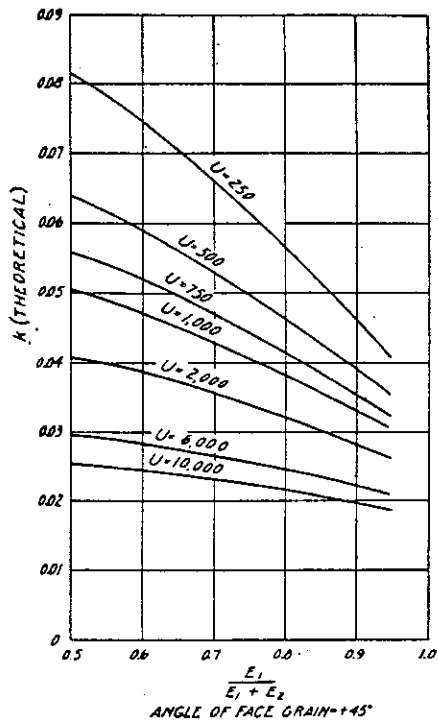
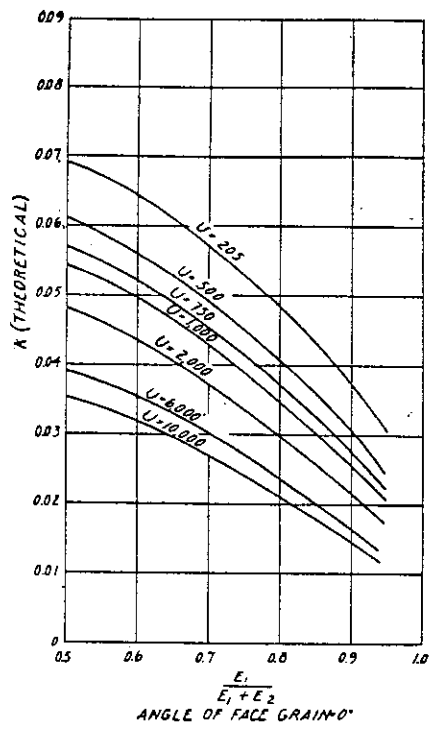

Figure 2-59. Theoretical buckling constants for thin-walled plywood cylinders in torsion, $W = 0.090$.

2.852. *Shear.*

2.8521. *Stiffener axial.* The stiffened curved panel can be considered to be a part of a stiffened cylinder. Thus the critical stress of the plywood panel without the stiffener is computed according to section 2.832. This stress is substituted for the left hand member of equation (2:118) using:

$$n = \frac{2\pi r}{a} \quad (2:121)$$

and the equation solved for the torque T . The stress applied to the edges of the stiffened panel which will cause it to buckle is then given by:

$$f_{scr} = \frac{T}{2\pi r^2 t} \quad (2:122)$$

This method leads to values which are slightly conservative.

2.9. Joints

2.90. BOLTED JOINTS.

2.900. *Bearing parallel or perpendicular to grain.*

The strength of wood in bearing parallel to the grain against solid steel aircraft bolts disposed along the member in single or double lines with the load divided equally between the two ends of the bolt (concentric loading) can be determined by use of figure 2-60. The stress at ultimate and at the proportional limit is expressed in terms of the maximum crushing strength for L/D ratios up to 16. The stress does not vary significantly below an L/D of 8 for softwoods and 5 for hardwoods but drops rapidly as the L/D ratio is increased above these values.

The ratio of ultimate bearing stress to the bearing stress at the proportional limit is 1.4 or less (fig. 2-61) at low L/D ratio for both softwoods and hardwoods. Thus, if a ratio of ultimate to limit bearing load higher than 1.4 is desired, it follows that the limit load in the low L/D range must be based on stresses below the proportional limit. For example, if a ratio of 1.5 is desired for softwoods (shown by broken lines in figs. 2-60 and 2-61) the limit load will be less than the proportional limit load up to an L/D ratio of 8.5 beyond which the proportional limit stress is used to determine the limit load.

The bearing strength of wood perpendicular to grain under aircraft bolts can be found by use of figure 2-62 (ref. 2-77). It may be noted that while bearing stress is only moderately reduced as the L/D ratio becomes greater than 9, there is a

marked variation with bolt diameter, particularly in the smaller sizes. The bearing stress at proportional limit when bearing perpendicular to grain, in general may be found with sufficient accuracy by dividing the ultimate bearing strength by 1.33 for all L/D ratios.

2.901. *Bearing at an angle to the grain* (ref. 2-61). When the load on a bolt is applied at an angle between 0° and 90° to the grain, the allowable load (proportional limit or ultimate) may be computed from the expression

$$N = \frac{PQ}{P \sin^2 \theta + Q \cos^2 \theta} \quad (2:123)$$

where

N = the allowable bolt load at angle θ

P = the allowable bolt load parallel to the grain

Q = the allowable bolt load perpendicular to the grain

θ = the angle between the applied load and the direction of the grain

Equation (2:123) is solved graphically by the Scholten Nomograph, figure 2-63.

2.902. *Eccentric loading.* When load is applied at only one end of a bolt (eccentric loading), the allowable ultimate load may be taken as one-half the ultimate two-end load computed as above. At proportional limit, however, the allowable eccentric load may be taken as only one-fourth of the two-end proportional limit load for two-end loading parallel to grain. This ratio may be increased to one-half if deformations approximately equal to those occurring at proportional limit under two-end loading are not objectionable even though they are well beyond those corresponding to the one-end proportional limit load.

Proportional limit values for one-end loading perpendicular to grain may be taken as one-half of the proportional limit values for two-end loading.

2.903. *Combined concentric and eccentric loadings; bolt groups.* When the design loads on a group of bolts are either all concentric or all eccentric and are all in the same direction, the allowable loads for the individual bolts may be added directly to determine the total allowable load for the group. When the design loads are in different directions (as when the load causes a moment about the centroid of the bolt group) or when they are partly concentric and partly eccentric, each bolt must be treated separately. The design loads and moments

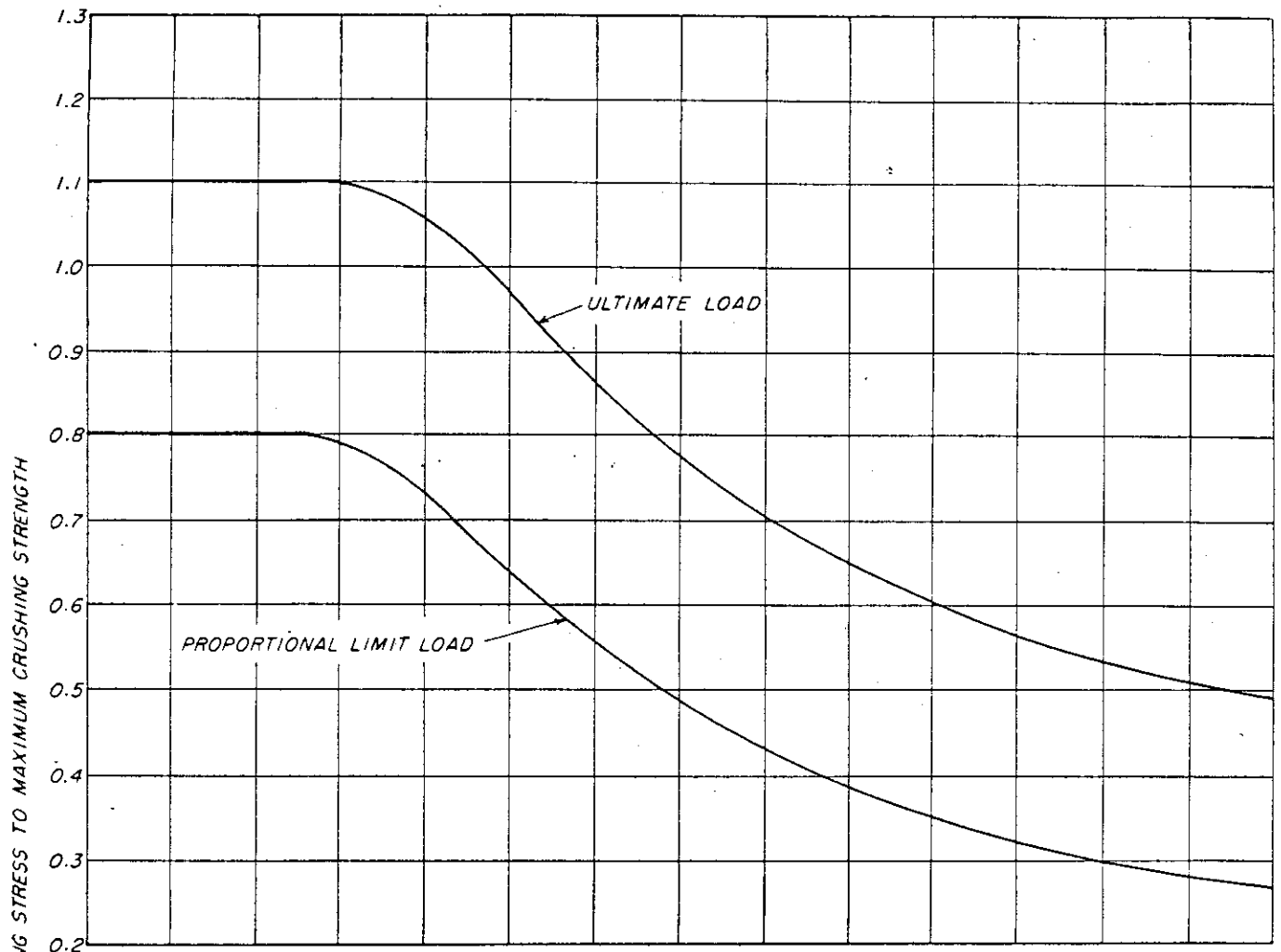

A

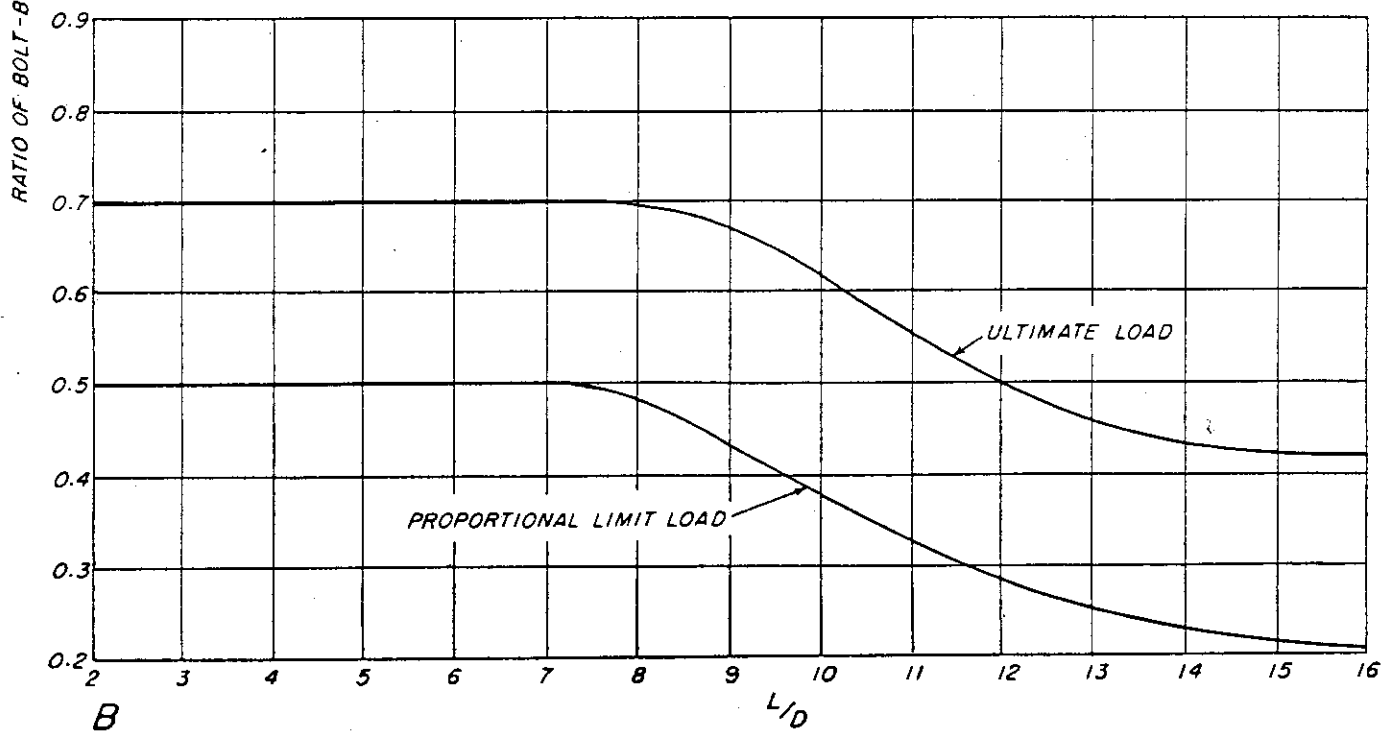

B

Figure 2-60. Relation between bearing strength and maximum crushing strength for wood under aircraft bolts bearing parallel to grain. A, hardwoods; B, softwoods.

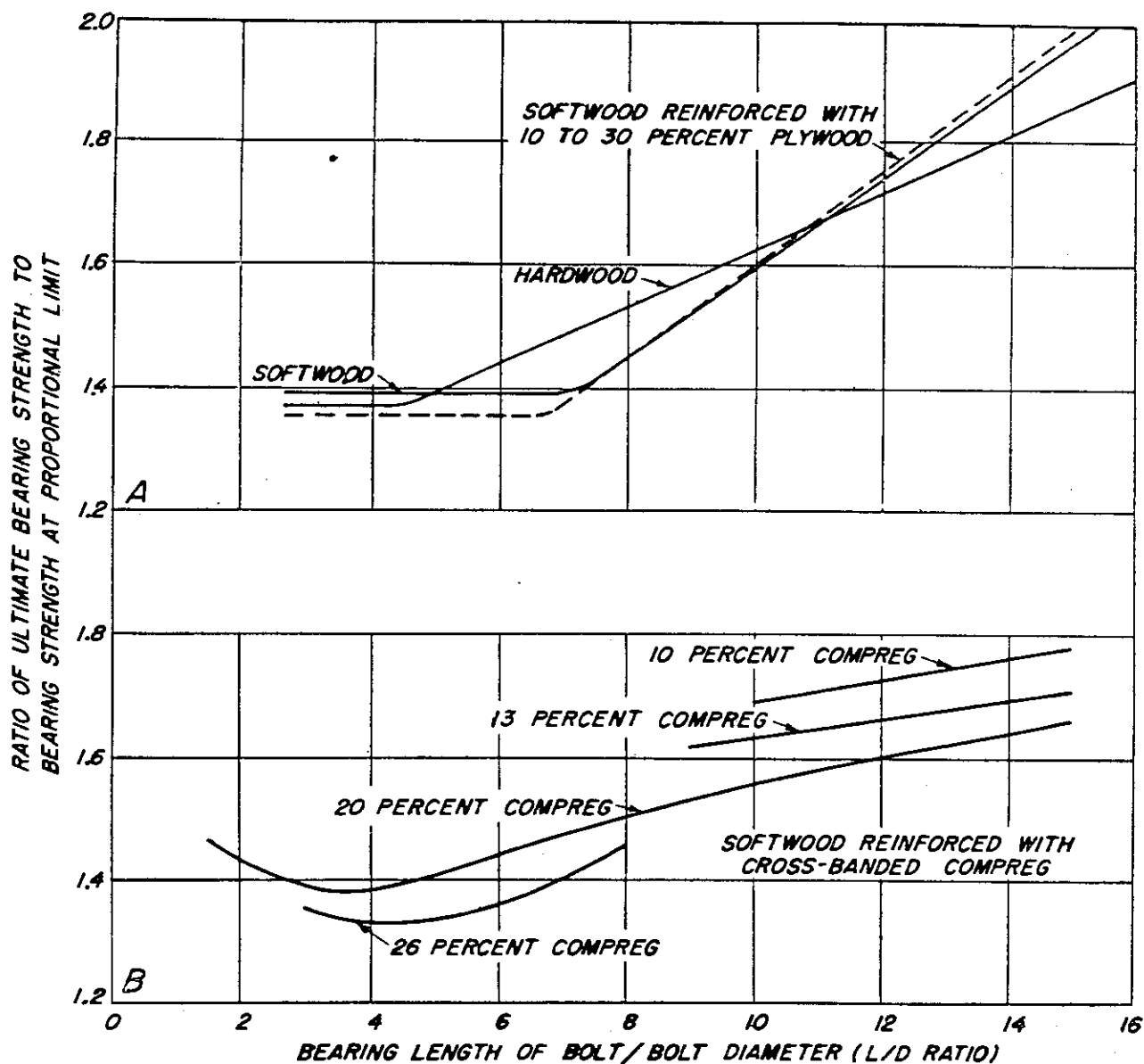

Z N 75272 T

Figure 2-61. Relation between ultimate bearing strength and bearing strength at proportional limit for various types of members.

must be distributed to each bolt in proportion to its resistance and the geometry of the bolt group. This often requires a trial and error calculation.

2.904. *Bolt spacings.* The following bolt spacing criteria are based on spruce. For other species the parallel-to-grain spacings and end margins should be multiplied by the expression:

$$K = \frac{F_{cp}}{3.57 F_{su}} \quad (2:124)$$

where

F_{cp} = allowable stress at proportional limit in compression parallel to the grain

F_{su} = allowable shearing stress parallel to the grain of the material

Spacings perpendicular to grain and edge margins as given below are applicable to all species.

2.9040. *Spacing of bolts loaded parallel to the grain.*

- (1) *Spacing parallel to the grain.* The minimum distance from the center of any bolt to the edge of the next bolt in a spruce member having cross-banded reinforcing plates, subjected to either tension or compression, is given in figure 2-64. The minimum distance from the edge of a bolt to the end of such a member subject to tension is also given. For spruce members without reinforcement these values must be increased by 50 percent.

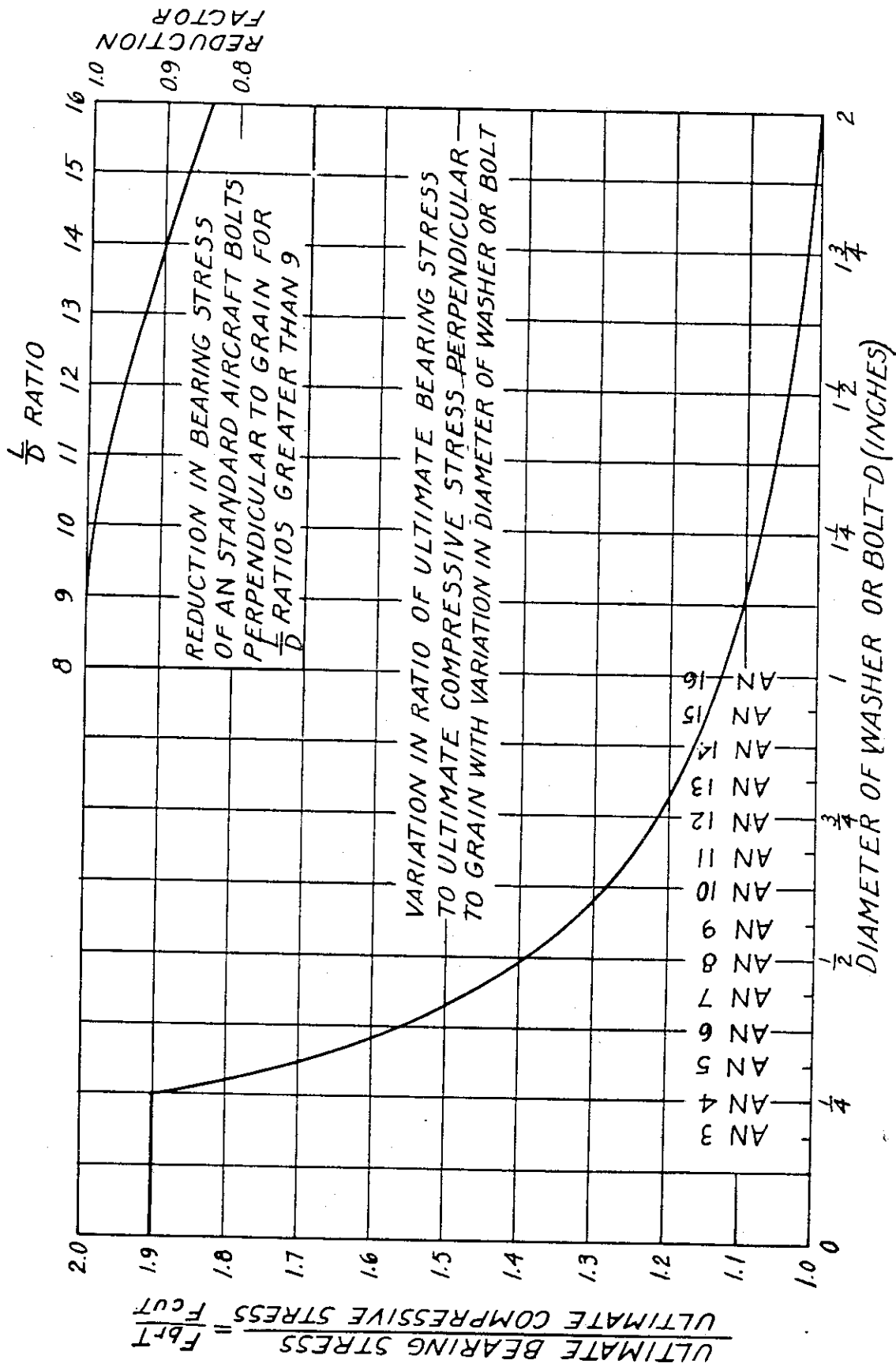
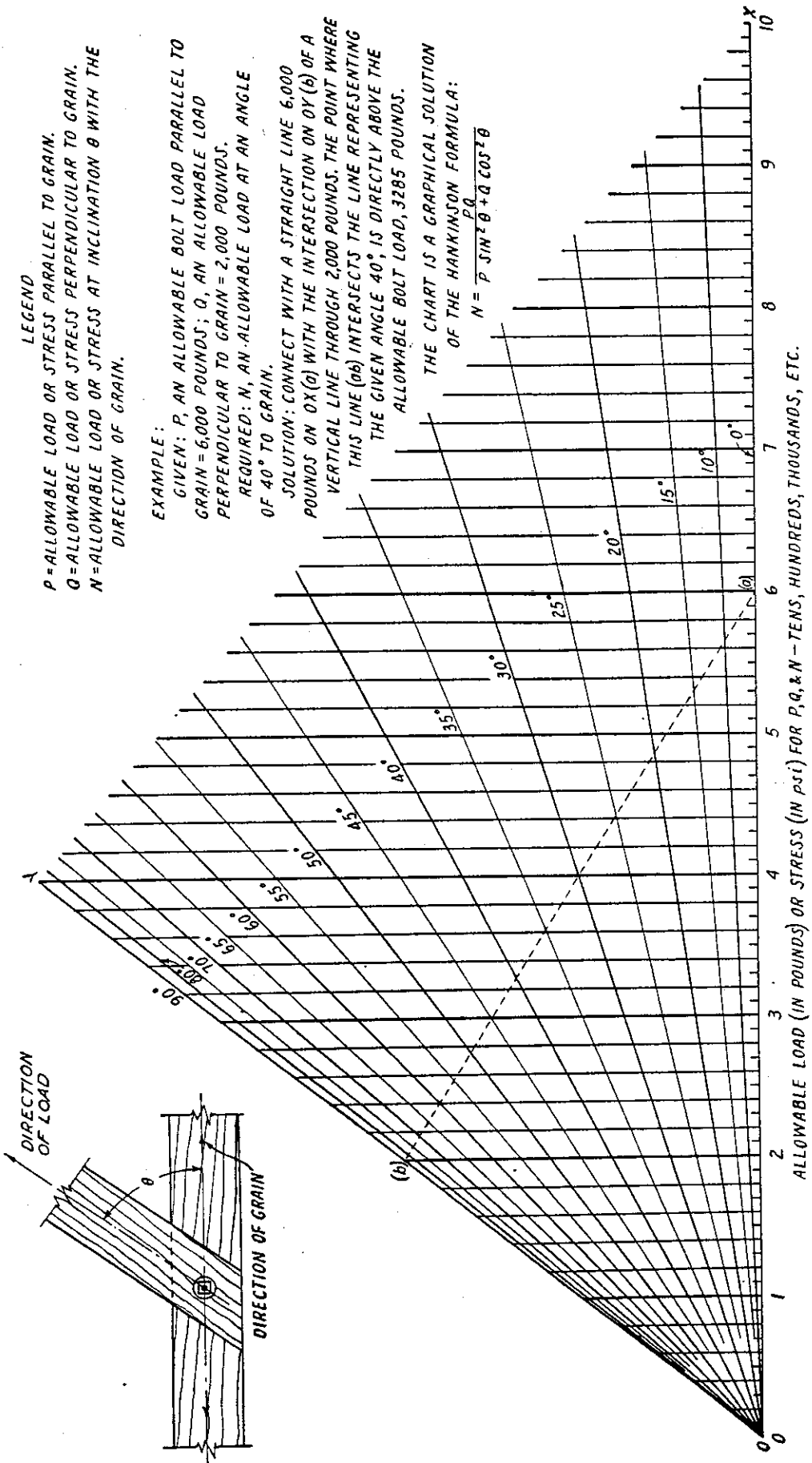

Figure 2-62. Bolt bearing stresses perpendicular to grain.



SCHOLTEN NOMOGRAPH FOR DETERMINING BEARING STRENGTH OF WOOD AT VARIOUS ANGLES TO THE GRAIN
 (REPRODUCED BY PERMISSION OF THE FOREST PRODUCTS LABORATORY)

Figure 2-63. Scholten nomograph for determining bearing strength of wood at various angles to the grain.

MINIMUM ALLOWABLE DISTANCES IN REINFORCED SPRUCE BETWEEN AN STANDARD AIRCRAFT BOLTS AND END OF TENSION MEMBERS WHEN BEARING IS PARALLEL TO GRAIN. SEE SECTION 2.904 FOR SPACINGS AND MARGINS IN OTHER SPECIES.

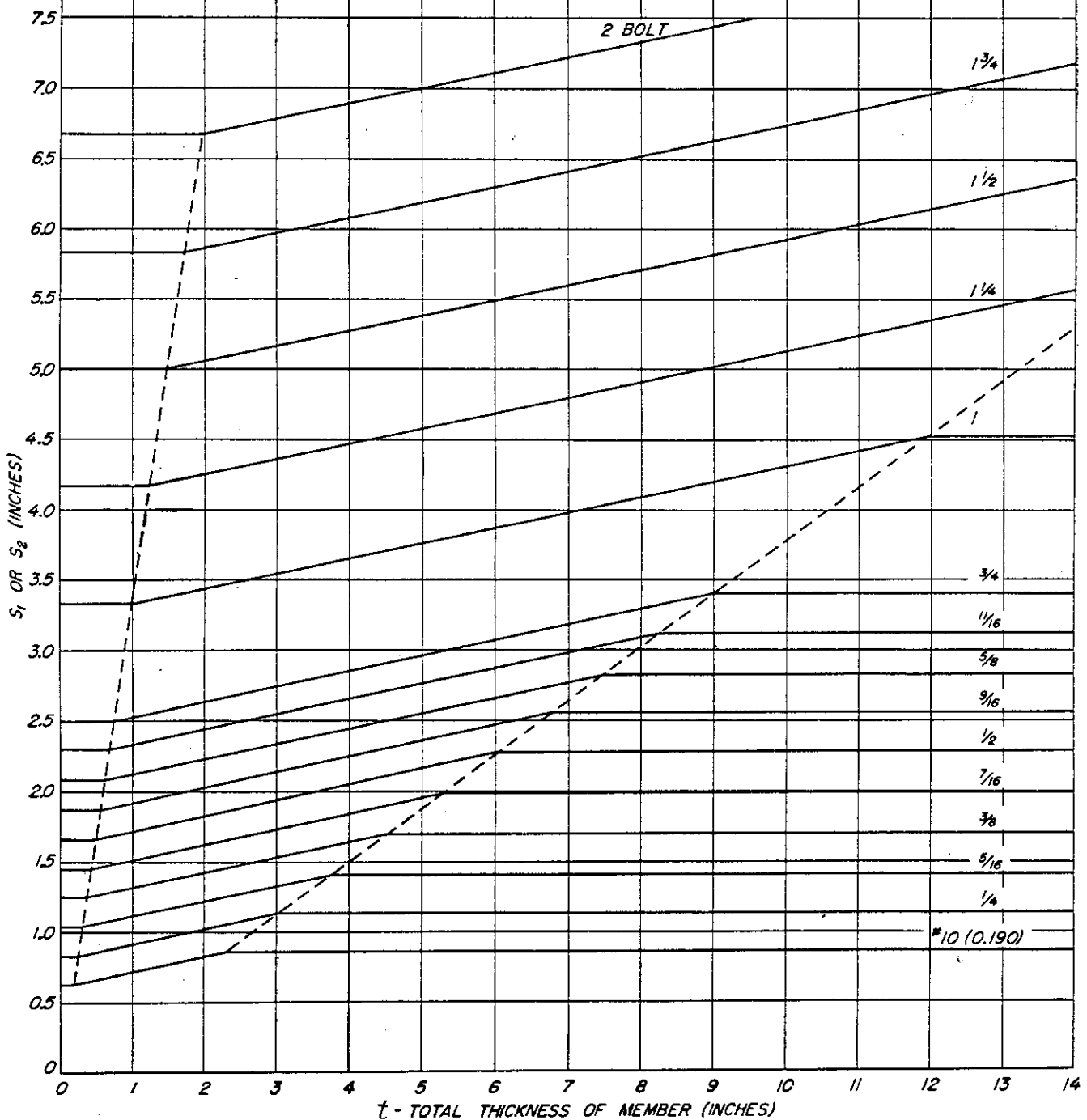
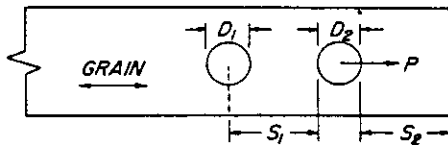

Figure 2-64. Allowable distances between bolts and allowable end margin for bolts in spruce members having cross-banded reinforcing plates when bearing is parallel to grain of spruce.

The minimum distance from the edge of a bolt to the end of a member subject to compression should be $3\frac{1}{2}$ bolt diameters.

- (2) *Spacing perpendicular to the grain.* The minimum distance between the edges of adjacent bolts or between the edge of the member and the edge of the nearest bolt should be one bolt diameter for all species. It is recommended that the stress in the area remaining to resist tension at the critical section through a bolt hole not exceed two-thirds the modulus of rupture in static bending when cross-banded reinforcing plates are used; otherwise one-half the modulus of rupture shall not be exceeded.
- (3) *When a bolt load is less than the allowable load parallel to the grain,* the spacing may be reduced in the following way: The bolt spacing given in figure 2-64 can be multiplied by the ratio of actual load to allowable load except that the spacing should be not less than three bolt diameters. The bolt spacing perpendicular to the grain cannot be reduced below one bolt diameter.

2.9041. *Spacing of bolts loaded perpendicular to the grain.*

- (1) *Spacing perpendicular to the grain.* The minimum distance from the edge of a bolt to the edge of the member toward which the bolt pressure is acting should be $3\frac{1}{2}$ bolt diameters. The margin on the opposite edge and the distance between the edges of adjacent bolts should be not less than one bolt diameter.
- (2) *Spacing parallel to the grain.* The minimum distance between edges of adjacent bolts should be three bolt diameters and the distance between the end of the member and the edge of the nearest bolt should be not less than four bolt diameters.
- (3) *When a bolt load is less than the allowable load perpendicular to the grain,* all bolt spacings may be multiplied by the ratio of actual load to allowable load except that the spacing should be not less than one bolt diameter. The distance between the end of the member and the edge of the nearest bolt, measured parallel to the grain, should be not less than three bolt diameters, however.

2.9042. *Spacing of bolts loaded at an angle to the grain.* When bolts are loaded at some angle to the grain, the load can be resolved into components parallel and perpendicular to the grain and the spacings thereafter determined in accordance with sections 2.9040 and 2.9041.

2.9043. *General notes on bolt spacing.* When bushings are used in combination with bolts, the spacing should be based upon the outside diameter of the bushing. When adjacent bolts or bushings are of different diameters, the spacing should be based upon the larger.

When staggered rows of bolts are employed in design, the distance between the center lines of adjacent bolt rows should be not less than the sum of the diameters of the largest bolt in each row.

2.905. *Bearing in wood-base materials.*

2.9050. *Bearing in plywood* (ref. 2-47). For plywood constructed of a single species in accordance with Specification AN-P-69a (*Plywood and Veneer; Aircraft Flat Panel*) or any other approximately balance construction (nearly equal thickness of material in both directions), the proportional limit bearing strength under solid steel aircraft bolts loaded at any angle to the face grain can be determined from figure 2-65. The proportional limit stress expressed in terms of the ultimate compressive stress is related to diameter of bolt for various thicknesses of plywood. Ultimate loads can be assumed to be at least 50 percent above these values.

For appreciably unbalanced constructions or for balanced constructions in which the use of two species results in an appreciable difference between F_{cuw} and F_{cuz} , the proportional limit bearing stresses under aircraft bolts may be found by multiplying the appropriate ratio from figure 2-65 by F_{cuw} for bolts loaded at 0° to the face grain and by F_{cuz} for bolts loaded at 90° to the face grain. For loadings at other angles, the proportional limit stresses may be found by straight-line interpolation between values found by the procedures given above for loadings at 0° and 90° .

The minimum distance from the edge of a bolt to the edge of a member in a single-bolt connection loaded parallel to the face grain is one diameter for either tensile or compressive loading. When the face grain is at 45° or 90° to the direction of loading, the edge distance must not be less than one and one-half diameters. Where several bolts disposed along the center line are employed in a connection, the edge distance should be determined by multiplying the single-bolt edge distance given above by

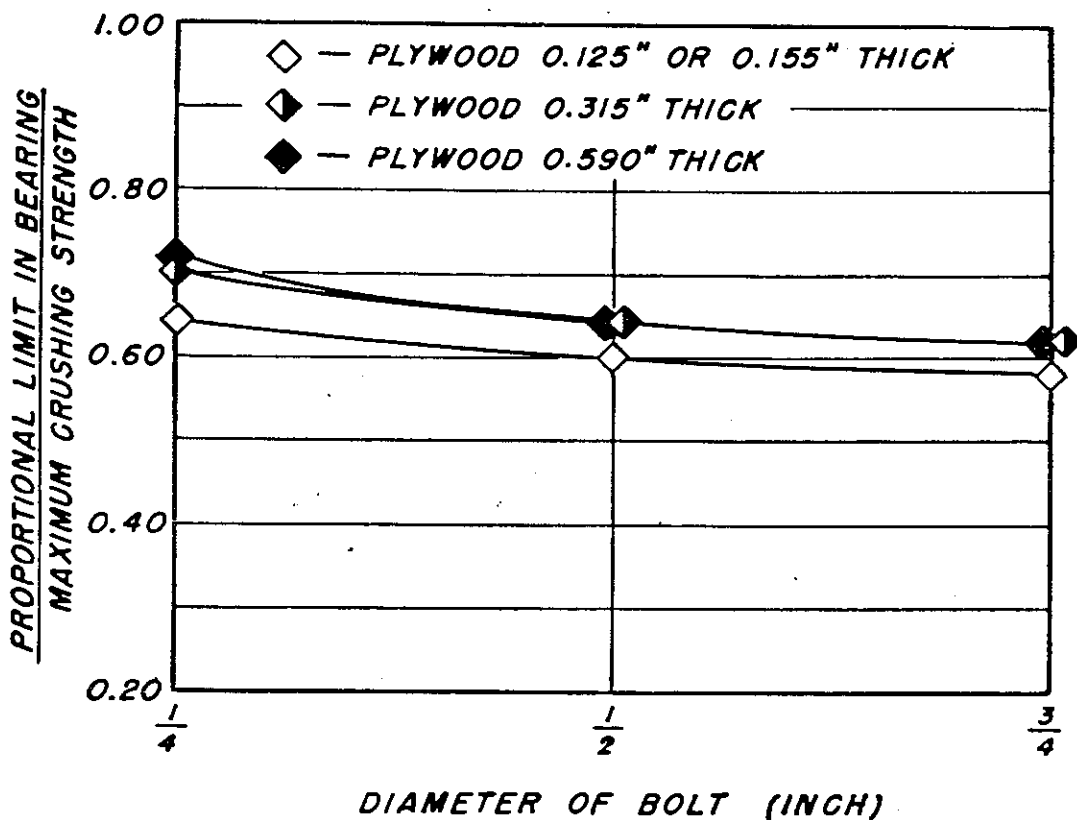

Figure 2-65. Relation of proportional limit bearing stress to maximum crushing strength of plywood for three bolt diameters and four thicknesses of plywood.

the number of bolts. Where bolts are disposed in two lines, each line should coincide with the center line of the half-width of the member in which the line of bolts is placed, and the edge distance for each line should be equal to the number of bolts in that line multiplied by the edge distance for a single bolt.

The minimum distance from the edge of the bolt to the end of the member is two diameters under tensile loading for any grain orientation. For compressive loading a minimum of one diameter should be used.

The most common use in which plywood will have to sustain boltbearing loads will be as reinforcing plates on solid wood members (sec. 2.906).

2.9051. *Bearing in compreg* (ref. 2-31). For cross-banded compreg of approximately balanced construction that conforms to AAF Specification 15065-B (*Panels: Compressed Wood, Impregnated*), the bearing strength under solid-steel aircraft bolts loaded at any angle to the grain can be determined from figure 2-66. The stress at proportional limit and at ultimate, expressed in terms of the ultimate compressive stress, is related to bolt diameter for several thicknesses of compreg. Ultimate loads are at least 50 percent above the proportional limit value.

No variation in bearing strength with direction of loading has been noted for unbalanced constructions tested. It is suggested, however, that when the unbalance exceeds a 60-40 relationship, the bearing stresses may be found by multiplying the appropriate ratio from figure 2-66 by F_{cuw} for bolts loaded at 0° to the face grain and by F_{cuz} for bolts loaded at 90° to the face grain. For loadings at other angles, the bearing stresses may be found by straight-line interpolation between values found by the procedures outlined above for loadings at 0° and 90° .

For a single-bolt joint under compressive loading, the minimum distance from the edge of the bolt to the edge of the member is one and one-half diameters for any grain orientation. The distance from the edge of the bolt to the end of the member should be at least one bolt diameter.

For a single-bolt joint loaded in tension, the minimum end or edge distances are the same and vary with the face grain orientation as follows: parallel and perpendicular to face grain, $4\frac{1}{2}$ diameters; 45° to face grain, $2\frac{1}{2}$ diameters.

For connections employing more than one bolt, edge distances should be determined as indicated for plywood in section 2.9050.

At a ratio of bearing length to bolt diameter of

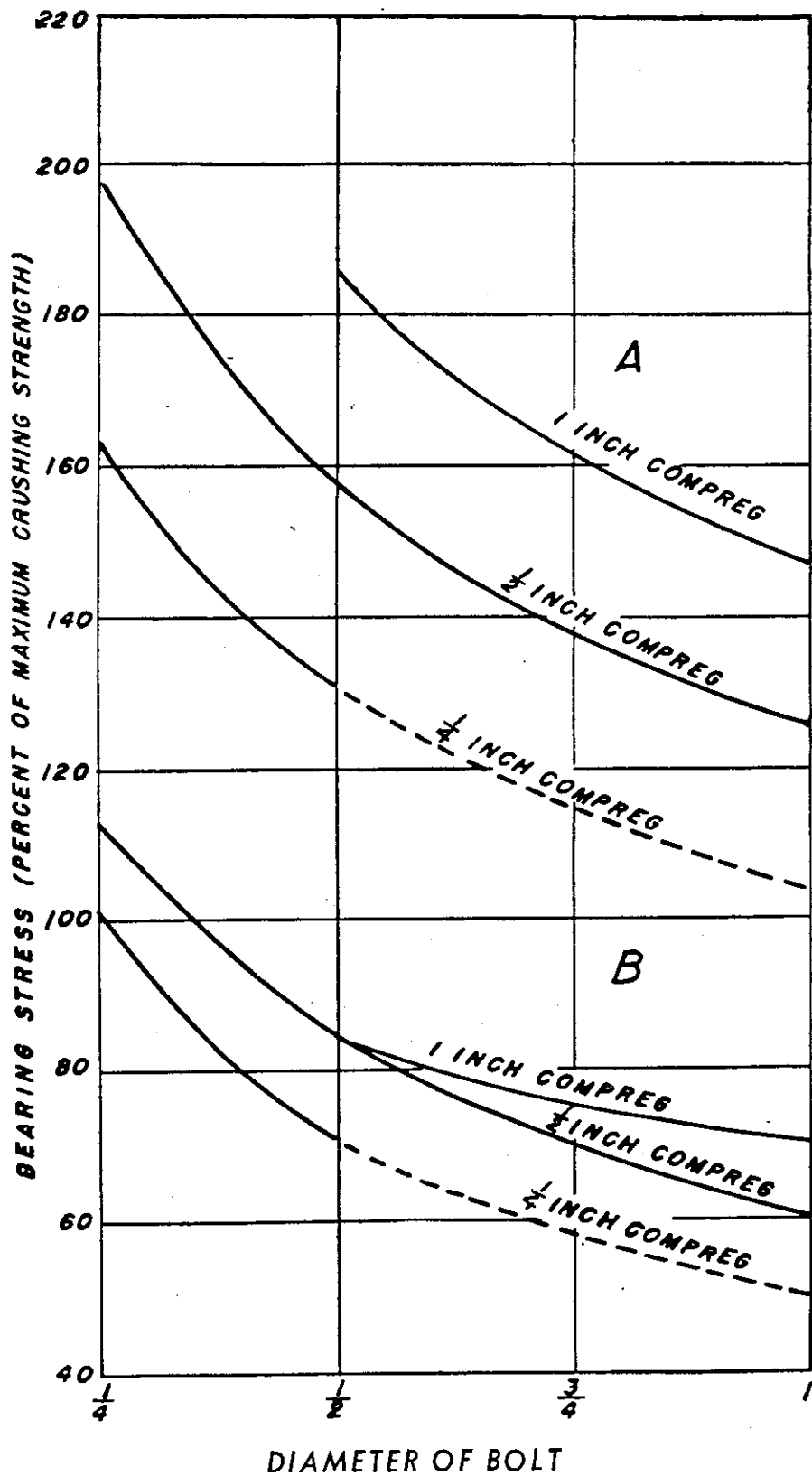

Figure 2-66. Ultimate (A) and proportional limit (B) bearing stresses of commercial cross-banded compreg expressed as percent of ultimate compressive stress for three diameters of bolts ($\frac{1}{4}$, $\frac{1}{2}$, and 1 inch) and for three thicknesses of compreg ($\frac{1}{4}$, $\frac{1}{2}$, and 1 inch).

4, the bearing strength of compreg exceeds the double shear strength of the bolt.

The most common use in which compreg will have to sustain bearing loads will be as reinforcing plates on solid wood members.

2.906. *Bearing in reinforced members* (ref. 2-68).

2.9060. *Wood members with plywood reinforcing plates.* The allowable limit bearing load parallel to the grain of members symmetrically reinforced with plywood (AN-P-69a), the thickness of which (two plates) is 10 to 30 percent of the total thickness of the member and reinforcement, under solid steel aircraft bolts may be determined as follows:

- (1) Select tentative thickness of reinforcement and diameter of bolt.
- (2) Compute the L/D ratio based on the total length of the bolt in bearing.
- (3) From figure 2-60 read the ordinate on the proportional limit curve for the wood member corresponding to the L/D ratio found in (2).
- (4) From figure 2-65 read the ordinate on the proportional limit curve for the thickness of reinforcement (one plate) and at the bolt diameter chosen.
- (5) Multiply the factors determined in steps (3) and (4) by the appropriate maximum crushing strengths to obtain the allowable proportional limit bearing stresses of the materials involved.
- (6) Multiply the stresses so obtained by the corresponding bearing areas to obtain the bearing load for each material. The summation of these bearing loads closely approximates the proportional limit bearing strength of the reinforced member, being only slightly conservative.

If the ratio of the ultimate stress to the proportional limit stress indicated by the curve of figure 2-61 for the construction chosen is less than the ratio of ultimate load to limit load (usually 1.5) specified by the design requirements, it is obvious that the limit bearing load chosen for use in design must be less than the load corresponding to proportional limit stress computed by the steps outlined above, and will be equal to the computed load multiplied by the ratio of the ordinate from the curve of figure 2-61 to the desired ratio. If on the other hand, the ratio from figure 2-61 is greater than that specified, the design ultimate bearing load must be less than the actual ultimate

load if the limit bearing load is to be no greater than the bearing load at proportional limit.

The preceding method applies to plywood reinforcing plates regardless of the angle between the load and the face grain direction.

The allowable concentric bearing load perpendicular to the grain can be obtained in a similar manner except that in step (3) figure 2-62 shall be used.

When the load on a bolt is applied at an angle between 0° and 90° to the grain, the allowable load on the wood member may be computed by substituting in equation (2:123) the parallel and perpendicular bearing loads determined by the methods outlined in the preceding paragraphs. For loads on the reinforcing plates refer to section 2.9050.

2.9061. *Wood members with cross-banded compreg reinforcing plates.* The allowable bearing stress parallel to the grain of wood members symmetrically reinforced with cross-banded compreg, the thickness of which (two plates) is 10 to 30 percent of the total thickness of the member and reinforcement, under solid steel aircraft bolts may be determined as follows:

- (1) Select tentative thickness of reinforcement and diameter of bolt.
- (2) Compute the L/D ratio based on the total length of the bolt in bearing.
- (3) From figure 2-60 read the ordinate on the ultimate stress curve corresponding to the L/D ratio found in (2).
- (4) From figure 2-66 read the ordinate on the ultimate stress curve for the thickness of reinforcement (one plate) and at the bolt diameter chosen in (1).
- (5) Multiply the factors determined in steps (3) and (4) by the appropriate maximum crushing strengths to obtain the allowable bearing stresses of the materials involved.
- (6) Multiply the stresses so obtained by the corresponding bearing areas to obtain the maximum bearing load for each material. The summation of these bearing loads is the maximum bearing strength.

The ratio of the ultimate stress to the proportional limit may be obtained from the curves in figure 2-61.

When compreg reinforcing plates are applied to members under tensile loading, the grain of the compreg must be at 45° to the direction of loading.

The allowable concentric bearing load perpendicular to the grain can be obtained in a similar manner except that in step (3) figure 2-62 shall be used.

When the load on a bolt is applied at an angle between 0° and 90° to the grain, the allowable load on the wood member may be computed by substituting in equation (2:123) the parallel and perpendicular bearing loads determined by the methods outlined in the preceding paragraphs. For loads on the reinforcing plates, refer to section 2.9051.

2.907. *Bushings.* Bushings of light alloys or fiber materials may be used to increase the bearing strength of bolts. Since the possible combinations of materials for bolts and bushings are numerous, a specific set of allowable loads for all possible combinations cannot be given.

The allowable bearing loads for aluminum bushings used in combination with steel bolts, and for other combinations of materials, should be determined by a special test.

2.908. *Hollow bolts.* The use of hollow bolts with comparatively thin walls for bearing in wood is not recommended, as tests at the Forest Products Laboratory show that such bolts are little if any more efficient on a weight basis than solid bolts. When used, the allowable stress parallel to the grain may be obtained from N. A. C. A. Technical Note 296 (ref. 2-77). In general, tests should be made to determine the allowable loads at other angles to the grain.

2.909. *General features of bolted joints.*

2.9090. *Drilling of holes* (ref. 2-27). In order to use the bolt-bearing stresses shown in the preceding sections, holes must have accurate alignment and spacing and the surfaces must be smooth and true. This requires control of rate of feed and rotational speed as well as selection of the proper type of drill. Most successful results have been obtained with a twist drill carefully centered in the chuck, rotated at the highest speed compatible with a reasonable drill life, and fed at a rate that will produce cutting, not tearing. In general, the smoothest hole produces the most desirable bolt-bearing characteristics.

2.9091. *Repeated loading of bolted joints.* The proportional limit load may be repeatedly applied without producing an appreciable increase in the deformation or "slip" of the joint. In general,

loads as high as 75 percent of the ultimate may be safely repeated without excessive deformation. Since this is close to the proportional limit for low L/D ratios, it is seen that the amount the load may be increased above the proportional limit increases with the L/D ratio. Since in a few cases in reinforced members the maximum safe value is below 75 percent of ultimate, it is probably best to consider the proportional limit to be the optimum limit load.

2.91. *GLUED JOINTS.*

2.910. *Allowable stress for glued joints* (ref. 2-48).

(1) An allowable glue joint stress equal to one-third F_{su} (column 14 of table 2-6) for softwoods or one-half F_{su} for hardwoods for the weaker species in the joint should be used for all plywood-to-plywood or plywood-to-solid-wood joints regardless of face grain direction and for joints between solid wood members in which the relative grain direction is essentially perpendicular. The reduction for joints in which the face grain direction of the plywood is parallel to the grain of the solid wood is necessary primarily because of the unequal stress distribution common to most plywood glue joints.

(2) The allowable shear stress on the glue area for all joints between pieces of solid wood having parallel-grain gluing, is equal to the allowable shear stress parallel to the grain for the weaker species in the joint. This value is found in column 14 of table 2-6 and should be used only when uniform stress distribution in the glue joint is assured.

(3) The allowable shear stress on the glue area for joints between pieces whose grain directions make an angle of other than 0° or 90° may be found by use of formula (2:123) (sec. 2.901), using allowable values for 0° and 90° joints computed as in (1) and (2) above. Figure 2-64 may be used for a graphical solution of formula (2:123). When the angle between the grain directions of the adjacent pieces does not exceed 15° , the shearing strength allowed for parallel-grain gluing as described in (2) above may be assumed to apply without correction.

2.911. *Laminated and spliced spars and spar flanges.* Requirements for laminated and spliced spars and spar flanges are presented in ANC-19, *Wood Aircraft Inspection and Fabrication* (ref. 2-24). Provisions for limiting the location of scarf joints and for the required slope of grain are included.

2.912. *Glue stress between web and flange.* The stress on the glue area between web and flange may be determined by dividing the maximum shear per inch in plywood by the area of contact per inch. For example, the shear stress on the area of contact is

$$f_s = \frac{f_s t}{d} = \frac{q}{d} \quad (2:125)$$

where

f_s = shear stress on the area of contact

f_s = the maximum shear stress in the plywood

t = thickness of one web

d = depth of the flange

q = shear per inch in the plywood

The allowable stress is determined according to section 2.910. If, for example, the flange were of spruce and the web of mahogany-yellow-poplar, the allowable stress would be one-third the value for spruce, or 330 pounds per square inch.

2.92. **PROPERTIES OF MODIFIED WOOD.** It is at times desirable to impart modified properties to wood for reinforcement at joints, bearing plates, and for other specific uses. Such modifications can be obtained by treating with synthetic resins, by compressing, or by a combination of treating and compressing.

Investigations at the Forest Products Laboratory have produced several types of modified-wood combinations, such as "impreg," "compreg," "semicompreg," and "staypak," which are described in ANC Bulletin 19 (ref. 2-24). When the resin is set within the structure by the application of heat prior to the application of assembly pressures, thus greatly limiting the compression of the wood, the material is called "impreg." When the treated wood is subjected to pressures in the range of 1,000 to 3,000 pounds per square

inch prior to the setting of the resin, resulting in a product with a specific gravity of 1.2 to 1.4, the material is called "compreg." Resin-treated wood with specific gravity values between that of impreg and compreg is known as "semicompreg." Ordinary laminated wood or solid wood with no resin within the intimate structure when compressed under conditions that cause some flow of lignin is known as "staypak." It differs from material made according to conventional pressing methods in that the tendency to recover its original dimensions when exposed to swelling conditions has been practically eliminated.

Some properties of parallel-laminated and cross-laminated modified wood made by the Forest Products Laboratory from 17 plies of $\frac{1}{8}$ -inch rotary-cut yellow birch, sweetgum, and Sitka spruce veneer are presented in tables 2-16 through 2-21 (ref. 2-18), in which average values resulting from the specified number of tests, together with maximum and minimum values are given. Values for normal laminated wood (controls), impreg, semicompreg, compreg, and staypak are presented. Conclusions drawn from these comparative tests must be regarded only as indicative, because the number of tests is limited.

2.920. *Detailed test data for tables 2-16 to 2-21, inclusive.* Specimens for test were obtained from three sets of 24- by 24-inch panels of each of the three species. Each set consisted of two seven-teen-ply panels of each of the five materials, one panel parallel-laminated and one cross-laminated. Panels of a set were formed by assembling corresponding plies of the panels from successive sheets of veneer as it came from the lathe. So far as possible, the veneer for each set was taken from a different log or bolt.

Except as otherwise noted, tests were made on specimens with the original or formed surfaces of the material undisturbed. In general, an equal number of specimens was tested from each of the two principal grain directions, lengthwise and crosswise (0° and 90°), that is, parallel and perpendicular, respectively, to the grain of parallel-laminated panels, and to the face grain of the cross-laminated panels.

Table 2-16. Some properties of parallel-laminated modified wood made by the Forest Products Laboratory from 17 plies of 1/16-inch rotary-cut yellow birch veneer

Thickness at test, specific gravity, type of test and property	Normal laminated wood 1 Unimpregnated, uncompressed				Impreg. 2 Impregnated, uncompress				Semimpreg. 2 Impregnated, moderately compressed				Compreg. 2 Impregnated, highly compressed				Stackup 1 Unimpregnated, highly compressed			
	Number of tests	Average	Minimum	Maximum	Number of tests	Average	Minimum	Maximum	Number of tests	Average	Minimum	Maximum	Number of tests	Average	Minimum	Maximum	Number of tests	Average	Minimum	Maximum
(1)	(2)	(3)	(4)	(5)	(6)	(7)	(8)	(9)	(10)	(11)	(12)	(13)	(14)	(15)	(16)	(17)	(18)	(19)	(20)	(21)
Thickness (t) of laminates..... inch		0.044	0.021	0.072		0.000	0.005	1.052		0.884	0.881	0.889		0.065	0.620	0.709		0.483	0.458	0.504
Specific gravity (based on weight and volume at test).....		0.73	0.60	0.79		0.94	0.84	1.03		1.00	0.92	1.07		1.34	1.31	1.36		1.40	1.36	1.43
Test and property:																				
1. Tension—parallel to grain (lengthwise).....	6				6				6				6				5			
Proportional limit stress psi.....		14,780	13,160	16,310		13,780	11,160	15,620		13,360	10,880	15,200		22,150	21,150	24,340		22,370	18,920	21,780
Ultimate strength..... psi		22,180	20,140	25,600		16,980	12,110	20,140		18,080	13,760	20,880		30,200	28,670	32,150		45,070	44,080	49,000
Modulus of elasticity 1,000 psi.....		2,300	2,006	2,712		2,495	2,076	2,814		2,742	2,423	3,024		3,701	3,468	4,041		4,810	4,380	4,860
Elongation 1..... Percent		1.02	0.94	1.06		0.70	0.65	0.74		0.62	0.55	0.75		0.79	0.75	0.85		1.08	0.97	1.15
2. Tension—perpendicular to grain (crosswise).....	9				8				5				6				9			
Proportional limit stress psi.....		750	510	1,010		980	540	1,460		1,200	1,030	1,300		1,570	1,410	1,920		1,800	1,660	2,150
Ultimate strength..... psi		1,420	1,080	1,630		1,080	820	1,460		1,440	1,250	1,710		1,980	1,490	2,540		3,300	3,120	3,660
Modulus of elasticity 1,000 psi.....		166	150	187		320	272	410		324	283	370		923	878	977		575	502	672
Elongation 2..... percent		1.00	0.69	1.18		0.34	0.29	0.46		0.45	0.34	0.58		0.23	0.16	0.27		0.88	0.74	1.04
3. Compression—parallel to grain (edgewise).....	12				12				12				12				11			
Proportional limit stress psi.....		6,440	5,340	7,680		8,580	7,370	9,520		9,310	7,660	10,080		16,400	14,340	17,960		9,710	8,000	12,540
Ultimate strength..... psi		9,550	8,740	11,120		15,580	13,840	17,000		16,030	14,840	17,400		27,800	26,760	28,650		19,100	18,360	20,560
Modulus of elasticity 1,000 psi.....		2,324	2,102	2,670		2,602	2,150	2,804		2,799	2,464	3,180		3,563	3,352	3,870		4,676	4,372	5,302
4. Compression—perpendicular to grain (edgewise).....	12				12				12				12				12			
Proportional limit stress psi.....		670	610	740		1,080	900	1,270		6,120	5,160	7,140		7,980	6,260	9,700		2,620	1,400	3,450
Ultimate strength..... psi		2,100	1,860	2,550		5,630	4,510	6,510		6,120	5,160	7,140		18,550	17,310	19,610		9,370	9,040	10,100
Modulus of elasticity 1,000 psi.....		162	147	175		301	243	344		324	289	376		788	757	836		583	456	627
5. Compression—perpendicular to grain (flatwise).....	12				12				12				12				7			
Proportional limit stress psi.....		1,030	900	1,200		2,240	1,870	3,170		2,280	1,800	2,580		8,810	6,580	11,640		5,540	4,870	6,000
Maximum crushing strength..... psi						5,000	3,700	6,500		6,120	4,980	7,220		16,340	13,360	18,080		13,200	13,760	14,100
6. Flexure—grain parallel to span (flatwise).....	12				12				12				12				12			
Proportional limit stress psi.....		11,550	9,560	13,900		14,660	11,130	18,100		16,860	14,600	20,480		21,650	19,380	25,270		29,150	15,460	25,300
Modulus of rupture..... psi		20,430	18,740	24,650		20,730	15,950	26,270		22,780	19,690	26,190		35,640	34,080	38,600		39,420	35,950	43,120

Modulus of elasticity 1,000 psi.	2,317	1,980	2,706	2,550	2,148	2,820	2,806	2,502	3,246	3,476	3,250	3,689	4,449	4,250	4,654
Work to proportional limit. In.-lb. per cu. in.	3.21	2.32	3.84	4.71	3.11	6.61	5.65	4.40	7.42	7.52	6.01	10.14	5.18	2.85	8.05
Work to maximum load In.-lb. per cu. in.	19.9	15.2	26.1	11.1	6.8	18.1	11.9	9.3	15.1	27.1	23.8	31.9	46.1	31.2	52.9
7. Flexure—grain perpendicular to span (flatwise): ¹	12						10			12					
Proportional limit stress psi.															
Modulus of rupture. psi.	1,030	860	1,180	1,480	910	1,890	1,320	940	1,500	4,200	3,840	4,660	3,190	2,770	4,140
Modulus of elasticity	1,920	1,750	2,180	1,690	1,110	2,260	1,730	1,270	2,140	5,550	4,050	6,080	5,090	4,160	5,620
Work to proportional limit. 1,000 psi.	153	135	170	301	246	357	326	265	406	782	708	781	602	528	666
Work to proportional limit. In.-lb. per cu. in.	0.39	0.28	0.57	0.44	0.13	0.64	0.33	0.12	0.47	1.31	1.06	1.69	0.95	0.60	1.48
Work to maximum load In.-lb. per cu. in.	1.66	1.34	2.39	0.58	0.21	0.97	0.60	0.25	0.95	2.44	1.27	3.50	3.0	1.7	4.4
8. Shear strength—parallel to grain (edge-wise): ¹															
a. Single shear across laminations. psi.	11	2,620	2,300	2,800	2,030	2,580	2,090	1,830	2,360	4,070	3,160	5,010	4,810	3,000	5,670
b. Johnson, double shear across laminations. psi.	12	2,980	2,850	3,110	3,460	4,460	4,430	3,880	4,680	7,370	6,780	8,270	6,370	6,130	6,550
c. Cylindrical double shear parallel to lami- nations. psi.	9	3,030	2,410	3,270	3,540	3,980				6,480	5,100	7,620	3,080	2,000	3,870
9. Modulus of rigidity (G): ²															
a. Plate shear (FPL test) 1,000 psi				3	217	165	207	195	220				385	307	403
o. Torsion method 1,000 psi.	6	182	163	208			207	196	228	6	315	359			
10. Toughness (FPL test, edge- wise): ⁴	12	235	174.3	280.6	151.2	98.7	166	100.9	236.5	6	136.8	173.1	248.4	183.9	302.9
Toughness In.-lb. per in. of width.		250.6	189.1	303.7	152.4	94.6	187.7	114.6	267.3		193	277.4	514.5	370.8	617.0
11. Impact strength (Izod): ⁵ Ft.-lb. per in. of notch.	13	12.65	7.05	20.63	1.97	1.13	3.17	1.70	5.61	15	5.40	6.74	12.72	11.60	14.37
12. Water absorption (24-hour immersion). percent					9	7.03	8.93	7.5	10.6	9	0.97	1.30	4.33	3.90	4.8
13. Dimensional stability of thickness (t)					9					9					
Equilibrium swelling plus recovery. percent.				4.5	3.5	6.0	6.0	5.7	6.3		8.4	10.6	33.7	30	37
Recovery from compres- sion. percent.													4.3	1.1	8.9
Equilibrium swelling percent.				4.5	3.5	6.0	6.0	5.7	6.3		8.4	10.6	20.4	28.1	31.1

¹ Veneer conditioned at 86° F. and 65 percent relative humidity prior to assembly with film glue. No

other resin employed. The average moisture content of the normal laminates at test was 9.2 percent

(range 8.3 to 9.9).

² Total resin content 49 to 54 percent, impregnating resin content 42 to 49 percent on the basis of the

dry weight of the untreated veneer.

³ Total elongation immediately before fracture measured over a 2-inch gage length.

⁴ Load applied to the edge of the laminations (perpendicular to laminating-pressure direction).

⁵ Load applied to the surface of the original material (parallel to laminating-pressure direction).

⁶ Modulus associated with shear distortions in planes parallel to the plane of the laminations.

Table 2-17. Some properties of parallel-laminated modified wood made by the Forest Products Laboratory from 17 plies of 1/16-inch rotary-cut *suwedqum veneer*

Thickness at test, specific gravity, type of test and property	Normal laminated wood ¹ Unimpregnated, uncompressed				Impreg ² Impregnated, uncompressed				Semiconp ² Impregnated, moderately compressed				Comper ² Impregnated, highly compressed				Slaypak ¹ Unimpregnated, lightly compressed			
	Number of tests	Average	Minimum	Maximum	Number of tests	Average	Minimum	Maximum	Number of tests	Average	Minimum	Maximum	Number of tests	Average	Minimum	Maximum	Number of tests	Average	Minimum	Maximum
(1)	(2)	(3)	(4)	(5)	(6)	(7)	(8)	(9)	(10)	(11)	(12)	(13)	(14)	(15)	(16)	(17)	(18)	(19)	(20)	(21)
Thickness (t) of laminates..... inch																				
Specific gravity (based on weight and volume at test).....		1.014	1.005	1.021		1.015	1.003	1.032		0.716	0.691	0.742		0.564	0.533	0.582		0.436	0.391	0.469
Test and property:																				
1. Tension—parallel to grain (lengthwise)	6				6								6				5			
Proportional limit stress p. s. l.																				
Ultimate strength do.		9,510	8,480	10,660		8,630	6,700	12,160		12,140	9,240	13,200		19,900	17,840	21,620		19,040	15,140	24,700
Modulus of elasticity		14,540	12,830	15,800		10,200	5,660	12,940		19,570	17,600	21,180		20,740	23,270	28,540		32,700	28,700	35,810
1,000 p. s. l. percent	6	1,622	1,500	1,808		1,861	1,731	1,937		2,530	2,399	2,688		2,968	2,806	3,121		3,765	3,493	4,116
2. Tension—perpendicular to grain (crosswise)	9	0.93	0.90	1.02	9	0.56	0.45	0.67		0.80	0.73	0.86		0.92	0.79	1.00		0.96	0.79	1.04
Proportional limit stress p. s. l.																				
Ultimate strength p. s. l.		460	350	580		590	440	800		930	660	1,100		3,030	2,470	3,210		1,410	880	2,450
Modulus of elasticity		1,000	860	1,060		700	510	880		1,150	860	1,440		3,870	3,570	5,000		2,530	2,390	3,490
1,000 p. s. l. percent	8	125	100	143		215	167	200		436	367	540		798	764	849		515	456	770
3. Compression—parallel to grain (edgewise) ⁴	12	0.96	0.74	1.28	12	0.33	0.22	0.48		0.24	0.16	0.35		0.48	0.44	0.67		0.84	0.65	1.10
Proportional limit stress p. s. l.																				
Ultimate strength p. s. l.		4,510	3,880	5,180		7,550	6,160	8,600		17,710	16,470	19,060		9,320	7,900	11,760		9,030	6,470	11,120
Modulus of elasticity		6,850	6,150	7,540		12,600	11,300	13,690		20,910	20,100	21,840		20,910	20,100	21,840		16,810	13,450	18,240
1,000 p. s. l. percent		1,663	1,541	1,842		1,873	1,695	2,049		2,616	2,420	2,799		3,350	3,030	3,820		3,852	3,380	4,228
4. Compression—perpendicular to grain (edgewise)	12				12															
Proportional limit stress p. s. l.																				
Ultimate strength p. s. l.		340	310	420		700	600	880		2,460	2,000	2,870		2,470	2,130	2,850		2,470	1,430	3,050
Modulus of elasticity		1,280	1,110	1,440		3,020	2,700	3,270		7,850	7,140	8,610		11,730	11,220	15,060		8,470	6,810	10,000
1,000 p. s. l. percent		120.5	105.6	133.3		190.0	173.3	219		422	316	465		666	632	698		511	367	630
5. Compression—perpendicular to grain (flatwise) ⁵	12				12															
Proportional limit stress p. s. l.																				
Maximum crushing strength p. s. l.		780	650	950		1,820	1,570	2,070		2,570	2,400	2,910		20,500	18,840	23,300		12,230	11,710	13,620
6. Flexure—grain parallel to span (flatwise) ⁶	12				12															
Proportional limit stress p. s. l.		8,170	7,050	9,760		9,580	6,990	12,500		15,910	13,710	18,480		19,940	16,920	22,730		17,680	15,630	20,600
Modulus of rupture p. s. l.		14,330	12,420	15,720		12,930	10,880	15,370		21,010	17,290	23,660		33,540	30,200	36,150		36,399	32,530	41,080

Modulus of elasticity 1,000 p. s. i.	1,586	1,346	1,760	1,859	1,782	2,024	2,458	1,922	2,781	3,108	2,960	3,308	3,805	3,116	4,473
Work to proportional limit In.-lb. per cu. in.	2.35	1.92	3.00	2.88	1.37	4.86	5.68	4.24	7.20	7.16	4.86	9.69	4.58	3.78	5.66
Work to maximum load In.-lb. per cu. in.	13.94	12.06	17.16	5.38	3.56	7.46	10.8	5.84	14.7	26.9	22.9	30.2	48.8	37.6	60.3
7. Flexure—grain perpendicular to span (flatwise): ¹	12						8								
Proportional limit stress p. s. i.	650	560	730	820	560	1,170	1,830	1,180	2,110	4,500	3,330	5,340	2,280	1,630	2,900
Modulus of rupture p. s. i.	1,280	1,060	1,470	1,180	660	1,470	2,090	1,520	2,450	6,580	5,760	8,000	4,130	3,520	5,110
Modulus of elasticity 1,000 p. s. i.	105	84.8	121	195	175	213	347	284	392	749	700	858	522	408	622
Work to proportional limit In.-lb. per cu. in.	0.23	0.20	0.28	0.20	0.09	0.40	0.57	0.20	0.77	1.61	0.86	2.24	0.57	0.28	0.86
Work to maximum load In.-lb. per cu. in.	1.14	0.78	1.39	0.44	0.13	0.71	0.84	0.32	1.46	3.50	2.68	4.36	2.35	1.61	3.31
8. Shear strength—parallel to grain (edgewise): ⁴															
a. Single shear across laminations, p. s. i.	12	2,170	1,850	1,880	1,450	2,240	2,710	2,250	3,100	4,060	2,630	5,080	4,250	3,370	4,780
b. Johnson, double shear across laminations p. s. i.	12	2,080	1,870	2,300	2,570	2,890	4,500	4,070	4,920	7,200	6,700	7,630	5,800	4,910	6,520
c. Cylindrical double shear parallel to laminations, p. s. i.	9	2,000	1,500	2,300	2,940	3,310									
9. Modulus of rigidity (G): ⁵															
a. Plate shear (PPL test), 1,000 p. s. i.	2	153	143	163	168	183									
b. Torsion method 1,000 p. s. i.	6	132	108	149											
10. Toughness (FPL test, edge- wise): ⁴	12	141.8	130.4	101.3	71.8	38.9	90	115.3	98.7	126.1	71.6	156.2	250.5	181.1	304.7
Toughness In.-lb. per in. of width		140.2	129.1	160	70.8	38.6	89.6	161.1	142.2	222.7	132.6	269.3	575.0	386.0	686.0
11. Impact strength (Izod) ⁶ Ft.-lb. per in. of notch	15	8.50	7.01	10.61	0.08	0.40	1.92	2.10	1.19	2.69	2.32	3.51	13.74	12.19	17.96
12. Water absorption (24-hour immersion) percent				14.25	10.58	16.63	9	7.44	6.68	8.05	0.80	1.22	5.95	4.16	8.89
13. Dimensional stability of thick- ness (0)							9								
Equilibrium swelling plus recovery percent				3.3	3.1	3.5		6.5	6.3	6.8	4.8	5.3	29.0	23.3	36
Recovery from compres- sion percent				0.8	0.8	0.8							3.6	0.6	7.9
Equilibrium swelling percent				2.5	2.3	2.7		6.5	6.3	6.8	4.8	5.3	25.4	22.7	28.1

¹ Veneer conditioned at 80° F. and 65 percent relative humidity prior to assembly with film glue. No other resin employed. The average moisture content of the normal laminates at test was 10.2 percent (range 9.1 to 10.0).

² Total resin content 37 to 52 percent, impregnating resin content 36 to 42 percent on the basis of the dry weight of the untreated veneer.

³ Total elongation immediately before fracture measured over a 2-inch gage length.

⁴ Load applied to the edge of the laminations (perpendicular to laminating-pressure direction).

⁵ Load applied to the surfaces of the original material (parallel to laminating-pressure direction).

⁶ Modulus associated with shear distortions in planes parallel to the plane of the laminations.

Proportional limit stress p. s. i.	7,280	5,780	8,470	8,720	6,180	9,990	14,790	9,700	16,430	26,540	24,380	29,610	21,700	18,480	27,600
Modulus of rupture p. s. i.	11,000	10,900	12,580	11,500	9,990	12,540	17,800	10,940	20,880	37,040	33,370	41,100	37,140	32,510	41,090
Modulus of elasticity 1,000 p. s. i.	1,669	1,579	1,734	2,179	2,130	2,214	2,800	2,650	3,118	4,262	4,007	4,521	4,923	4,420	5,560
Work to proportional limit, in.-lb. per cu. in.	1.78	1.10	2.36	1.98	0.97	2.57	4.21	1.90	5.01	9.21	8.00	11.08	5.41	3.43	8.76
Work to maximum load In.-lb. per cu. in.	11.12	6.22	13.70	3.64	2.76	4.25	6.08	2.84	9.03	20.31	16.86	24.14	32.5	23.3	42.5
7. Flexure—grain perpendicular to span (flatwise) ¹	12	8	12	8	8	12	12	8	8	8	10	10	10	10	10
Proportional limit stress p. s. i.	570	410	690	770	720	880	1,670	1,550	2,070	5,510	5,140	6,700	2,600	1,600	3,820
Modulus of rupture p. s. i.	780	680	970	900	780	1,140	2,040	1,580	2,620	5,980	5,270	7,100	4,680	3,580	5,900
Modulus of elasticity 1,000 p. s. i.	89.5	85	91.9	177	167	187	370	341	406	782	740	830	585	560	688
Work to proportional limit, in.-lb. per cu. in.	0.21	0.11	0.29	0.19	0.16	0.22	0.42	0.28	0.61	2.19	1.31	3.15	0.70	0.30	1.22
Work to maximum load In.-lb. per cu. in.	0.43	0.25	0.67	0.27	0.19	0.42	0.72	0.41	1.42	2.65	2.00	3.65	2.70	1.48	3.68
8. Shear strength—parallel to grain (edgewise): ¹	12	12	12	8	8	12	12	12	12	7	7	12	12	12	12
a. Single shear across lami- nations p. s. i.	1,470	1,360	1,550	1,540	1,330	1,720	2,580	2,300	2,800	3,570	2,620	4,410	4,830	4,560	5,080
b. Johnson, double shear across laminations p. s. i.	1,880	1,780	1,950	2,550	2,180	2,970	3,950	3,570	4,210	7,500	6,730	8,140	6,780	5,680	6,050
c. Cylindrical double shear parallel to laminations p. s. i.	1,420	1,140	1,700	1,530	1,250	2,040	2,500	2,340	2,650	2,720	2,090	3,820	1,800	1,300	2,340
9. Modulus of rigidity (G): ²	6	115	103	158	156	160	250	234	265	401	391	410	398	398	398
a. Plate shear (FPL test) 1,000 p. s. i.	117.7	91.5	147.9	47.6	37	61.1	65.2	45.4	79.5	104	63	117.5	146.4	85.1	167.6
b. Torsion method 1,000 p. s. i.	119.2	91.3	152.5	55.6	43.6	70.5	107.8	73.4	132.3	239.7	213.8	274	432	213.2	556.8
10. Toughness (FPL test, edge- wise): ³ in.-lb.	0	10.23	7.47	2.20	1.16	3.97	3.33	1.75	5.69	4.21	2.83	5.48	6.75	5.8	8.7
Toughness In.-lb. per in. of width.															
11. Impact strength (Izod): ⁴ ft.-lb. per in. of notch.															
12. Water absorption (24-hour immersion) percent.				6	15.67	14.36	7.36	6.1	8.9	1.46	1.41	1.54	6.75	5.8	8.7
13. Dimensional stability of thickness (t) percent.				6											
Equilibrium swelling plus recovery percent.				4.7	4.3	5.1	6.2	6.9	6.5	8.4	8.2	8.7	21.8	22.8	28.7
Recovery from compres- sion percent.													1.2	1.0	1.5
Equilibrium swelling percent.				4.7	4.3	5.1	6.2	5.9	6.5	8.4	8.2	8.7	23.6	21.8	27.2

¹ Veneer conditioned at 80° F. and 65 percent relative humidity prior to assembly with film glue.
² No other resin employed. The average moisture content of the normal laminates at test was 8.9 percent (range 8.3 to 9.3).
³ Total resin content 55 to 58 percent, impregnating resin content 36 to 42 percent on the basis of the dry weight of the untreated veneer.
⁴ Total elongation immediately before fracture measured over a 2-inch gage length.
⁵ Load applied to the edge of the laminations (perpendicular to laminating-pressure direction).
⁶ Load applied to the surface of the original material (parallel to laminating-pressure direction).
⁷ Modulus associated with shear distortions in planes parallel to the plane of the laminations.

Table 2-19. Some properties of cross-laminated modified wood made by the Forest Products Laboratory from 17 plies of 1/4-inch rotary-cut yellow birch veneer

Thickness at test, specific gravity, type of test and property	Normal laminated wood 1 Unimpregnated, uncompressed						Impreg 2 Impregnated, uncompressed						Semicompr 2 Impregnated, moderately compressed						Compr 2 Impregnated, highly compressed						Stackpak 1 Unimpregnated, highly compressed						
	Average		Minimum		Maximum		Average		Minimum		Maximum		Average		Minimum		Maximum		Average		Minimum		Maximum		Average		Minimum		Maximum		
	(2)	(3)	(4)	(5)	(6)	(7)	(8)	(9)	(10)	(11)	(12)	(13)	(14)	(15)	(16)	(17)	(18)	(19)	(20)	(21)	(22)	(23)	(24)	(25)	(26)	(27)	(28)	(29)	(30)		
Thickness (t) of laminates..... inch.																															
Specific gravity (based on weight and volume at test).....		0.855	0.933	0.980		1.040	1.020	1.051		0.939	0.889	1.009		0.669	0.622	0.720		0.497	0.465	0.551											
Test and property:		0.72	0.69	0.77		0.89	0.84	0.95		0.95	0.91	0.99		1.34	1.31	1.35		1.39	1.35	1.41											
1. Tension—parallel to face grain (lengthwise).....	6				6																										
Proportional limit stress																															
Ultimate strength... p. s. i.		7,330	6,030	9,240		7,070	5,200	7,980		7,710	5,760	9,940		8,820	7,060	10,580		15,270	11,080	23,680											
Modulus of elasticity		12,300	10,030	14,700		7,990	6,760	9,160		9,200	7,770	10,260		16,510	14,300	17,850		21,500	18,630	29,190											
1,000 p. s. i.		1,292	1,063	1,535		1,458	1,278	1,700		1,558	1,456	1,616		2,195	2,071	2,296		2,573	2,242	3,138											
Elongation 3..... percent.		1.04	1.00	1.11		0.55	0.47	0.51		0.60	0.50	0.68		0.82	0.77	0.88		1.12	0.83	1.41											
2. Tension—perpendicular to face grain (crosswise).....	8				9																										
Proportional limit stress																															
Ultimate strength... p. s. i.		6,580	5,440	8,300		5,960	4,720	7,380		7,140	5,030	7,760		8,070	6,750	9,200		11,230	8,080	16,420											
Modulus of elasticity		12,690	10,620	15,240		7,380	6,670	8,140		8,760	6,430	10,320		12,630	10,120	14,640		25,740	22,620	29,400											
1,000 p. s. i.		1,144	1,007	1,403		1,366	1,203	1,478		1,425	1,329	1,490		2,240	2,100	2,325		2,467	2,031	2,969											
Elongation 3..... percent.		1.07	1.06	1.00		0.56	0.50	0.61		0.63	0.44	0.75		0.51	0.50	0.52		1.12	0.99	1.21											
3. Compression—parallel to face grain (edgewise) 4.....	12				12																										
Proportional limit stress																															
Ultimate strength... p. s. i.		3,330	2,520	4,660		5,280	4,370	6,000		4,000	4,190	5,210		8,710	7,810	9,630		11,230	8,100	16,420											
Modulus of elasticity		5,810	5,300	6,600		11,460	10,050	13,000		10,990	9,980	11,560		23,950	23,300	25,590		25,740	22,620	29,400											
1,000 p. s. i.		1,362	1,164	1,592		1,505	1,363	1,744		1,532	1,414	1,633		2,327	2,182	2,530		2,701	2,462	3,173											
4. Compression—perpendicular to face grain (edgewise) 4.....	12				12																										
Proportional limit stress																															
Ultimate strength... p. s. i.		2,740	2,050	3,510		10,920	10,360	11,480		10,760	9,990	11,560		19,200	18,200	20,160		22,701	20,660	27,600											
Modulus of elasticity		5,420	4,620	6,260		23,300	19,440	25,300		18,466	18,460	25,510		33,550	31,680	35,400		40,060	33,930	44,040											
1,000 p. s. i.		1,310	1,174	1,598		1,349	1,218	1,452		1,466	1,388	1,554		2,091	1,980	2,230		2,255	1,931	2,532											
5. Compression—perpendicular to grain (flatwise) 5.....	12				11																										
Proportional limit stress																															
Maximum crushing strength... p. s. i.		980	850	1,160		2,220	1,910	2,580		2,300	2,000	2,800		8,800	6,900	12,040		8,140	6,800	10,820											
6. Flexure—face grain parallel to span (flatwise) 5.....	12				12																										
Proportional limit stress																															
Modulus of rupture		6,900	5,540	8,800		8,160	4,230	11,450		9,550	6,760	11,820		11,300	12,630	17,560		11,440	9,440	14,800											
1,000 p. s. i.		13,130	10,840	15,480		11,410	7,780	14,020		12,670	11,100	15,710		22,780	19,110	25,290		25,120	21,480	27,600											

Modulus of elasticity 1,000 p. s. i.	1,315	1,056	1,628	1,677	1,421	1,082	1,063	1,561	1,750	2,478	2,318	2,699	2,009	2,080	3,351
Work to proportional limit In.-lb. per cu. in.	2.02	1.42	2.77	2.31	0.62	3.06	3.31	1.58	4.56	4.06	3.62	6.30	2.55	1.78	4.03
Work to maximum load In.-lb. per cu. in.	14.5	9.91	17.9	4.89	2.41	6.66	6.19	4.54	10.9	15.0	10.1	18.7	24.1	10.4	36.6
7. Flexure—face grain perpendicular to span (flatwise) ⁵ Proportional limit stress p. s. i.	12		11				12			12		8			
Modulus of rupture p. s. i.	4,890	4,280	5,930	6,430	5,000	7,720	6,750	3,960	9,050	8,120	6,450	10,120	9,170	7,200	10,140
Modulus of elasticity 1,000 p. s. i.	11,330	9,560	12,700	7,910	5,800	9,880	8,760	5,950	10,370	16,060	13,700	17,980	23,680	22,460	21,940
Work to proportional limit In.-lb. per cu. in.	1.045	0.917	1.232	1,156	1,062	1,250	1,320	1,224	1,410	1,973	1,828	2,136	2,112	2,074	2,172
Work to maximum load In.-lb. per cu. in.	1.29	0.94	1.83	2.01	1.38	2.08	2.00	.66	3.23	1.91	1.09	2.94	2.23	1.35	2.63
8. Modulus of rigidity (G): ⁶ a. Plate shear (FPL test) 1,000 p. s. i. b. Torsion method	14.8	11.2	17.7	3.37	1.02	5.42	3.61	1.67	5.14	9.16	6.19	11.6	33.7	25.6	40.5
9. Toughness (FPL test, edge-wise) ⁷ In.-lb. Toughness In.-lb. per in. of width	8	171	180	215	212	221	221	213	227				375	362	391
	12	100	89.5	43.8	33.7	50.3	43	27.7	63.1	71.7	61.8	82.6	166.5	111.6	169.8
		105.5	94.0	42	32.2	56.6	45.8	30.9	62.9	107.3	98.5	116.1	321.4	212.7	400.5

¹ Veneer conditioned at 80° F. and 65 percent relative humidity prior to assembly with film glue.

² No other resin employed. The average moisture content of the normal laminates at test was 9.5 percent (range 8.9 to 10.2).

³ Total elongation immediately before fracture measured over a 2-inch gage length.

⁴ Load applied to the edge of the laminations (perpendicular to laminating-pressure direction).

⁵ Load applied to the surface of the original material (parallel to laminating-pressure direction).

⁶ Modulus associated with shear distortions in planes parallel to the plane of the laminations.

Table 2-20. Some properties of cross-laminated modified wood made by the Forest Products Laboratory from 17 plies of $\frac{1}{16}$ -inch rotary-cut spruce-veneer

Thickness (t) of laminates, inch. Specific gravity (based on weight and volume at test). Test and property:	Normal laminated wood † Unimpregnated, uncompressed				Impreg. 2 Impregnated, uncompressed				Semicomprong 2 Impregnated, moderately compressed				Comprong 2 Impregnated, highly compressed				Staypak 1 Unimpregnated, highly compressed			
	Number of tests	Average	Minimum	Maximum	Number of tests	Average	Minimum	Maximum	Number of tests	Average	Minimum	Maximum	Number of tests	Average	Minimum	Maximum	Number of tests	Average	Minimum	Maximum
	(2)	(3)	(4)	(5)	(6)	(7)	(8)	(9)	(10)	(11)	(12)	(13)	(14)	(15)	(16)	(17)	(18)	(19)	(20)	(21)
(1)																				
Thickness (t) of laminates..... inch.		1.012	1.003	1.025		1.013	0.999	1.030		0.691	0.673	0.698		0.562	0.531	0.587		0.416	0.402	0.488
Specific gravity (based on weight and volume at test).....		0.58	0.55	0.61		0.72	0.70	0.75		1.07	1.02	1.12		1.34	1.32	1.36		1.32	1.25	1.37
Test and property:																				
1. Tension—parallel to face grain (lengthwise).....	12				6				6				6				6			
Proportional limit stress																				
p. s. i.																				
Ultimate strength, p. s. i.		6,620	5,420	8,860		4,780	3,560	5,800		6,320	5,120	7,200		9,080	8,340	10,030		11,520	7,800	18,110
Modulus of elasticity		9,070	8,100	9,620		5,890	5,220	6,940		9,440	7,160	11,250		15,380	13,400	16,500		19,770	16,220	23,400
1,000 p. s. i.		914	853	994		1,083	1,039	1,131		1,524	1,338	1,705		1,997	1,880	2,065		2,136	1,806	2,232
2. Tension—perpendicular to face grain (crosswise).....	6	1.04	0.97	1.11		0.56	0.50	0.64		0.64	0.54	0.77		0.85	0.72	1.02		0.96	0.84	1.11
Proportional limit stress																				
p. s. i.		4,430	3,770	4,780	9	3,480	2,880	4,010		6,420	5,640	7,160		7,700	6,140	8,900		9,970	6,210	12,650
Ultimate strength, p. s. i.		8,970	7,820	9,620		5,230	4,580	5,740		9,220	8,360	9,940		13,200	12,200	13,860		21,870	16,040	26,550
Modulus of elasticity		862	766	936		1,055	976	1,152		1,384	1,291	1,495		1,911	1,782	2,020		1,991	1,616	2,248
1,000 p. s. i.		1.05	1.03	1.07		0.51	0.43	0.58		0.70	0.65	0.77								
3. Compression—parallel to face grain (edgewise) 4.....	2				12															
Proportional limit stress																				
p. s. i.		2,510	2,070	2,910		4,380	3,860	4,960		4,960	4,380	5,420		7,940	6,870	8,970		4,990	4,170	5,810
Ultimate strength, p. s. i.		4,140	3,700	4,480		8,270	8,020	8,780		13,240	11,860	14,560		21,700	20,900	22,500		12,110	11,040	13,080
Modulus of elasticity		970	845	1,073		1,116	1,038	1,177		1,664	1,543	1,801		2,232	2,094	2,352		2,161	1,825	2,383
1,000 p. s. i.																				
4. Compression—perpendicular to face grain (edgewise) 4.....	12				12															
Proportional limit stress																				
p. s. i.		2,390	2,070	2,650		3,770	3,350	4,300		4,960	4,380	5,420		7,940	6,870	8,970		4,990	4,170	5,810
Ultimate strength, p. s. i.		3,910	3,520	4,320		7,570	7,380	7,840		13,090	11,980	14,060		21,700	20,900	22,500		11,520	10,280	12,600
Modulus of elasticity		901	850	996		1,067	950	1,082		1,478	1,387	1,613		1,906	1,793	2,088		1,832	1,700	2,112
1,000 p. s. i.																				
5. Compression—perpendicular to grain (flatwise) 5.....	12				12															
Proportional limit stress																				
p. s. i.		860	750	1,000		1,680	1,300	1,980		2,700	2,100	3,630		31,750	29,080	36,380		33,500	30,690	35,900
Maximum crushing strength..... p. s. i.																				
p. s. i.		4,940	3,700	5,340		6,150	4,900	6,980		8,860	7,460	10,700		11,580	9,240	13,930		10,650	8,500	12,730
6. Flexure—face grain parallel to span (flatwise) 5.....	12				11															
Proportional limit stress																				
p. s. i.		9,140	8,440	9,990		8,300	6,780	9,260		14,050	11,180	15,960		18,990	14,420	22,250		21,010	21,090	26,380
Modulus of rupture																				
p. s. i.																				

Modulus of elasticity 1,000 p. s. i.	967	1,116	1,132	1,062	1,206	1,081	1,418	1,846	2,204	1,984	2,471	2,424	2,221	2,708
Work to proportional limit. In.-lb. per cu. in.	1.42	1.81	1.80	1.13	2.50	2.62	1.00	3.51	3.47	1.92	5.11	2.67	1.45	3.71
Work to maximum load In.-lb. per cu. in.	10.13	8.32	3.66	2.25	4.72	8.41	5.71	11.0	11.8	6.0	16.1	30.67	25.22	37.30
7. Flexure—face grain perpendicular to span (flatwise) ¹ Proportional limit stress	12	12	12			12			12			12		
Modulus of rupture p. s. i.	3,906	3,620	4,680	3,770	5,680	7,150	4,870	8,320	9,510	7,210	11,300	7,620	5,780	9,600
Modulus of elasticity 1,000 p. s. i.	7,740	7,190	6,410	5,140	7,390	9,700	7,600	10,890	15,520	13,710	17,030	20,110	16,740	22,140
Work to proportional limit. In.-lb. per cu. in.	735	658	904	846	990	1,206	1,074	1,334	1,750	1,634	1,851	1,748	1,550	1,808
Work to maximum load In.-lb. per cu. in.	1.20	0.94	1.36	0.93	1.81	2.38	1.23	2.97	2.93	1.72	3.03	1.80	0.98	2.71
8. Modulus of rigidity (G): ² a. Plate shear (FPI, test) 1,000 p. s. i.	9.35	8.22	2.76	1.66	3.95	5.12	3.46	6.62	9.8	7.2	11.4	31.18	19.87	35.42
b. Torsion method 1,000 p. s. i.	2	159	150	108	108	231	212	241	384	379	388	331	312	345
9. Toughness (FPI test, edge-wise) ³ Toughness In.-lb. per in. of width	120	101	138											
	68.4	58	76.4	22.4	37.5	50.6	31.9	104.4	42.9	31.7	61.4	133.3	73.8	106.6
	67.8	57.3	75.7	21.9	37.1	72.9	45.8	150.6	75.5	54.3	106.2	290	152.8	426.5

¹ Veneer conditioned at 80° F. and 65 percent relative humidity prior to assembly with film glue.

No other resin employed. The average moisture content of the normal laminates at test was 10.1 percent (range 9.2 to 10.8).

² Total resin content 37 to 52 percent, impregnating resin content 36 to 42 percent on the basis of the dry weight of the untreated veneer.

³ Total elongation immediately before fracture measured over a 2-inch gage length.

⁴ Load applied to the edge of the laminations (perpendicular to laminating-pressure direction).

⁵ Load applied to the surface of the original material (parallel to laminating-pressure direction).

⁶ Modulus associated with shear distortions in planes parallel to the plane of the laminations.

Table 2-21. Some properties of cross-laminated modified wood made by the Forest Products Laboratory from 17 plies of 1/16-inch rotary-cut Sitka spruce veneer.

Thickness at test, specific gravity, type of test and property	Normal laminated wood 1 Unimpregnated, uncompressed			Impreg 2 Impregnated, uncompressed			Semimpreg 2 Impregnated, moderately compressed			Compreg 2 Impregnated, highly compressed			Staypak 1 Unimpregnated, highly compressed							
	Num-ber of tests	Aver-age	Mini-mum	Num-ber of tests	Aver-age	Mini-mum	Num-ber of tests	Aver-age	Mini-mum	Num-ber of tests	Aver-age	Mini-mum	Num-ber of tests	Aver-age	Mini-mum					
(1)	(2)	(3)	(4)	(5)	(6)	(7)	(8)	(9)	(10)	(11)	(12)	(13)	(14)	(15)	(16)	(17)	(18)	(19)	(20)	(21)
Thickness (t) of laminates. inch		0.986	0.962	1.013		0.781	0.760	0.802		0.616	0.588	0.631		0.432	0.425	0.437		0.334	0.327	0.343
Specific gravity based on weight and volume at test		0.46	0.44	0.48		0.73	0.72	0.75		0.94	0.91	0.98		1.31	1.32	1.36		1.36	1.34	1.39
Test and property:																				
1. Tension—parallel to face grain (lengthwise)	6				6								4				7			
Proportional limit stress p. s. i.		5,810	4,900	6,600		5,500	4,900	5,900	6	7,440	6,620	8,800		13,920	13,240	14,690		17,590	19,020	19,020
Ultimate strength p. s. i.		7,740	7,220	8,200		1,452	1,416	1,528	3	1,932	1,866	1,994		2,875	2,751	2,948		3,046	2,765	3,266
Modulus of elasticity 1,000 p. s. i.	1	0.8				0.39	0.34	0.43		0.42	0.40	0.46		0.56	0.52	0.58		1.01	0.95	1.21
Elongation 2 percent	1																			
Tension—perpendicular to face grain (crosswise)	9				8				9				6				7			
Proportional limit stress p. s. i.		5,440	4,560	6,260		4,410	3,300	4,800		6,590	5,800	7,500		11,460	9,800	13,000		14,910	19,980	19,980
Ultimate strength p. s. i.		7,400	6,400	8,340		4,900	4,270	5,720	6	7,440	6,620	8,800		13,010	11,800	14,040		23,880	21,540	25,000
Modulus of elasticity 1,000 p. s. i.	4	0.81	0.73	0.91		0.37	0.31	0.41		0.39	0.35	0.44		0.51	0.50	0.54		0.98	0.99	1.09
Elongation 2 percent	4																			
Compression—parallel to face grain (edgewise) 1	12				12				12				8				12			
Proportional limit stress p. s. i.		3,040	2,670	3,500		4,640	4,220	5,270		10,750	10,000	12,200		10,040	8,720	11,440		6,510	4,760	7,860
Ultimate strength p. s. i.		3,910	3,710	4,100		7,320	6,900	8,020	11	10,750	10,000	12,200		21,740	21,150	22,250		12,260	11,110	13,200
Modulus of elasticity 1,000 p. s. i.	12	1,052	968	1,148		1,434	1,360	1,488		1,876	1,792	1,900		2,738	2,622	2,875		2,881	2,518	3,220
Compression—perpendicular to face grain (edgewise) 4	12				12				12				8				12			
Proportional limit stress p. s. i.		2,840	2,260	3,350		4,240	3,300	4,720		4,240	3,300	4,720		9,700	8,860	11,980		6,360	5,280	6,910
Ultimate strength p. s. i.		3,530	3,200	3,700		7,070	6,410	7,780	12	10,860	9,860	12,650		21,740	20,940	23,020		11,860	10,820	13,090
Modulus of elasticity 1,000 p. s. i.	12	969	898	1,055		1,321	1,250	1,374		1,687	1,569	1,835		2,682	2,591	2,818		2,710	2,382	3,190
Compression—perpendicular to grain (flatwise) 5	12				12				12				8				12			
Proportional limit stress p. s. i.		340	300	370		700	550	850		820	690	1,200		8,100	8,070	8,130		7,200	5,370	9,300
Maximum crushing strength p. s. i.						24,020	22,900	25,900	6	21,770	20,410	22,420		31,250	28,120	34,690		37,520	33,440	41,270
Flexure—face grain parallel to span (flatwise) 3	12				12				11				8				8			
Proportional limit stress p. s. i.		3,950	3,680	4,240		5,850	4,670	7,050		7,740	6,720	9,120		15,440	13,400	18,840		13,150	11,290	14,320
Modulus of rupture p. s. i.		6,680	6,020	7,580		8,300	6,180	9,700		10,160	9,260	12,350		23,690	20,360	25,740		24,480	21,220	26,540

Modulus of elasticity 1,000 p. s. i.	655	590	706	1,426	1,361	1,475	1,840	1,669	2,117	2,960	2,879	3,000	2,995	2,951	3,002
Work to proportional limit In.-lb. per cu. in.	1.32	1.12	1.44	1.35	.87	1.92	1.82	1.36	2.26	4.55	3.26	6.66	3.22	2.39	3.83
Work to maximum load In.-lb. per cu. in.	7.40	5.04	10.90	2.94	1.67	4.12	3.68	2.72	5.15	11.76	8.68	15.24	25.2	22	35.1
7. Flexure—face grain perpendicular to span (flatwise) ¹ Proportional limit stress p. s. i.	12									8					
Modulus of rupture p. s. i.	3,680	3,260	4,190	4,910	3,980	5,960	4,700	3,530	7,680	13,360	12,480	14,070	9,595	7,140	13,130
Modulus of elasticity 1,000 p. s. i.	5,750	5,390	6,290	6,250	5,220	7,400	7,670	6,810	9,920	15,240	14,640	16,360	22,075	20,840	24,290
Work to proportional limit In.-lb. per cu. in.	531	466	597	1,109	1,065	1,217	1,396	1,148	1,554	2,290	2,262	2,343	2,545	2,305	2,670
Work to maximum load In.-lb. per cu. in.	1.43	1.19	1.74	1.23	0.82	1.72	0.95	0.45	2.34	4.34	3.79	4.84	2.08	1.15	3.59
8. Modulus of rigidity (G) ² a. Plate shear (FPL test) 1,000 p. s. i.	6.07	4.84	7.14	2.16	1.41	3.13	2.58	1.81	4.00	6.34	5.47	7.48	26.4	22.6	30.4
b. Torsion method 1,000 p. s. i.	3			180	185	104	249	225	269	3	427	431	426		
9. Toughness (FPL test, edge-wise) ³ In.-lb.	6	64.5	88.6												
Toughness In.-lb. per in. of width	12	51.3	57.7	11	18.2	12.7	18.7	15.3	21.3	8	34.5	46.6	78.7	53.6	107.1
		52.4	60.2		23.3	16.5	30.4	24.0	36.1		80.1	108.1	233.5	158.2	319.6

¹ Veneer conditioned at 80° F. and 65 percent relative humidity prior to assembly with film glue.

No other resin employed. The average moisture content of the normal laminates at test was 8.7 percent (range 8.3 to 9.2).

² Total resin content 55 to 58 percent, impregnating resin content 36 to 42 percent on the basis of the dry weight of the untreated veneer.

³ Total elongation immediately before fracture measured over a 2-inch gage length.

⁴ Load applied to the edge of the laminations (perpendicular to laminating-pressure direction).

⁵ Load applied to the surface of the original material (parallel to laminating-pressure direction).

⁶ Modulus associated with shear distortions in planes parallel to the plane of the laminations.

Tension parallel to grain (test 1, tables 2-16 to 2-21, incl.). Specimens were 1 inch wide by panel thickness t by 24 inches long, shaped to have a $2\frac{1}{2}$ -inch long central section $\frac{1}{4}$ -inch wide. The taper followed a 60-inch radius on each edge.

Tension perpendicular to grain and parallel to laminations (test 2, tables 2-16 to 2-21, incl.). Specimens were 1 inch by t by 16 inches long, shaped to have a $2\frac{1}{2}$ -inch long central section $\frac{1}{2}$ -inch wide for tables 2-16, -17 and -18, and $\frac{1}{4}$ -inch wide for tables 2-19, -20, and -21, with radii of 30 and 20 inches, respectively.

Compression parallel to grain (test 3, tables 2-16 to 2-21, incl.) and perpendicular to grain and parallel to laminations (test 4, tables 2-16 to 2-21, incl.). Specimens were 1 inch by t by $3\frac{1}{2}$ to 4 inches long for the controls; impreg and semicompreg specimen lengths were approximately $4t$. Compreg and staypak specimens were 1 inch by t by 2 to 4 inches long (approx. $6t$) for proportional limit and modulus data, and 1 by t by 1 to 2 inches long (approx. $3t$) for maximum stress.

Compression perpendicular to laminations (test 5, tables 2-16 to 2-21, incl.). Specimens were 1 by 1 inch by panel thickness t , except for compreg and staypak, which consisted of two thicknesses of material, each 1 inch square, placed one upon the other. Deformations were measured between the fixed and movable heads of the testing machine.

Flexure (tests 6 and 7, tables 2-16 to 2-21, incl.). Specimens 1 inch wide by height t were tested as simple beams with center loading on spans ranging from $14t$ to $16t$.

Shear parallel to grain and perpendicular to laminations (test 8, tables 2-16 to 2-18, incl.). Notched specimens were 2 inches by t by $2\frac{1}{2}$ inches (as illustrated in fig. 17 of ASTM specifications for tests of small clear timber specimens, Designation D143-50) with shearing surface 2 inches by t . Specimens tested in the Johnson-type shear tool were 1 inch by t by 3 inches (two 1-inch by t shearing surfaces). Cylindrical double-shear specimens, $\frac{3}{8}$ -inch in diameter, were tested parallel to grain and parallel to laminations in a three-plate jig by means of tensile loading.

Modulus of rigidity tests (test 9, tables 2-16, -17, and -18; and test 8, tables 2-19, -20, and

-21) were conducted on panels approximately 24 inches square by full thickness of the material, using the plate shear method developed by the Forest Products Laboratory for measuring the shearing moduli of wood, as described in Forest Products Laboratory report No. 1301 and ASTM Designation D805-47. Torsion tests were conducted on rectangular specimens of width $3t$ by thickness t by 16 to 24 inches long, gripped flatwise and with a detrusion measuring device applied to their edges. Following tests on these, with torque kept within the proportional limit, specimens were cut to a width of $2t$ and the test repeated.

Toughness (test 10, tables 2-16, -17, and -18; and test 9, tables 2-19, -20, and -21) specimens $\frac{3}{8}$ by t by 10 inches long with grain of parallel-laminated material and face grain of cross-laminated material parallel to length were tested over an 8-inch span on the Forest Products Laboratory toughness machine with plane of laminations parallel to direction of load.

Impact (Izod type) specimens (test 11, tables 2-16, -17, and -18) had the grain lengthwise and the notch in an original surface. Some of the staypak specimens were less than $\frac{1}{2}$ inch thick, but the dimension from the base of the notch to the opposite face was standard.

Water absorption (test 12, tables 2-16, -17, and -18) specimens were 1 by $\frac{3}{8}$ by 3 inches. The grain was parallel to the 1-inch dimension. One surface of each specimen was an original face sanded, and all of its other surfaces were machined. Specimens were heated for 24 hours at 122° F., cooled, weighed, and immersed in water at room temperature for 24 hours, and the percentage increase in weight during immersion was calculated.

Dimensional stability of thickness t (test 13, tables 2-16, -17, and -18) was determined by the equilibrium swelling and recovery from compression of specimens $\frac{1}{8}$ inch by t by 2 inches long (grain parallel to the $\frac{1}{8}$ -inch dimension). Specimens were immersed in water at room temperature until equilibrium moisture content was reached, and the percentage increase in thickness (swelling plus recovery) was calculated. The specimens were then oven-dried, measured, and percentage recovery and equilibrium swelling determined.

REFERENCES FOR CHAPTER 2

- (2-1) ALLIOTT, E. A.
1926. *Effect of Acids on the Mechanical Strength of Timber: A Preliminary Study*. Soc. Chem. Indus. Jour. Trans. 45:463-466, illus.
- (2-2) BAILEY, C. M. AND RICHARDS, N. E.
1947. *The Effect of Temperature on the Strength of Wooden Aircraft Structures*. Coun. Sci. Ind. Res. (Aust.) Div. Aero Report SM 95.
- (2-3) BROKAW, M. P. AND FOSTER, G. W.
1945. *Effect of Rapid Loading and Duration of Stress on the Strength Properties of Wood Tested in Compression and Flexure*. Forest Products Laboratory Report No. 1518.
- (2-4) BROWN, C. R.
1934. *The Determination of the Ignition Temperatures of Solid Materials*. The Catholic Univ. of America, Washington, D. C.
- (2-5) BROWN, G. H., HOYLER, C. N., AND BIERWIRTH, R. A.
1947. *Theory and Application of Radio-Frequency Heating*. 425 pp. D. Van Nostrand Co., Inc.
- (2-6) DOYLE, D. V. AND DROW, J. T.
1946. *The Elastic Properties of Wood—Young's Moduli, Moduli of Rigidity, and Poisson's Ratio of Mahogany and Khaya*. Forest Products Laboratory Report No. 1528-C.
- (2-7) ———, DROW, J. T., AND MCBURNEY, R. S.
1945. *The Elastic Properties of Wood—The Young's Moduli, Moduli of Rigidity, and Poisson's Ratios of Balsa and Quipo*. Forest Products Laboratory Report No. 1528.
- (2-8) ———, MCBURNEY, R. S., AND DROW, J. T.
1946. *The Elastic Properties of Wood—The Moduli of Rigidity of Douglas-Fir at About 11 Percent Moisture Content*. Forest Products Laboratory Report No. 1528-E.
- (2-9) ———, MCBURNEY, R. S., AND DROW, J. T.
1946. *The Elastic Properties of Wood—The Moduli of Rigidity of Sitka Spruce and Their Relations to Moisture Content*. Forest Products Laboratory Report No. 1528-B.
- (2-10) DROW, J. T.
1945. *Effect of Moisture on the Compression, Bending, and Shear Strength and on the Toughness of Plywood*. Forest Products Laboratory Report No. 1519.
- (2-11) ———
1945. *Effect of Hydraulic Equipment Oils on the Bending and Compressive Strength of Sitka Spruce*. Forest Products Laboratory Report No. 1520.
- (2-12) ———, AND CLARK, M. E.
1945. *Moisture Content of Wood in Airplane Structures*. Forest Products Laboratory Report No. 1552.
- (2-13) ———, CLARK, M. E., AND WILSON, T. R. C.
1946. *Distribution of Strength Values in Wood for Aircraft Construction*. Forest Products Laboratory Report No. 1515.
- (2-14) ———, AND LISKA, J. A.
1943. *Effect of Moisture on the Compressive Strength of Plywood and Laminated Wood*. Forest Products Laboratory Report No. 1306.
- (2-15) ———, AND MCBURNEY, R. S.
1946. *The Elastic Properties of Wood—Young's Moduli and Poisson's Ratios of Sitka Spruce and Their Relations to Moisture Content*. Forest Products Laboratory Report No. 1528-A.
- (2-16) ———, AND MCBURNEY, R. S.
1946. *The Elastic Properties of Wood—Young's Moduli, Moduli of Rigidity, and Poisson's Ratios of Yellow Birch*. Forest Products Laboratory Report No. 1528-H.
- (2-17) ———, AND MCBURNEY, R. S.
1946. *The Elastic Properties of Wood—Young's Moduli, Moduli of Rigidity, and Poisson's Ratios of Yellow-Poplar*. Forest Products Laboratory Report No. 1528-G.
- (2-18) ERICKSON, E. C. O.
1947. *Mechanical Properties of Laminated Modified Wood*. Forest Products Laboratory Report No. R1639.
- (2-19) ERICKSON, H. D. AND REES, L. W.
1940. *Effect of Several Chemicals on the Swelling and the Crushing Strength of Wood*. Jour. Agr. Research 60:593-603.
- (2-20) FOREST PRODUCTS LABORATORY
1940. *Wood Handbook*. U. S. Department of Agriculture Unnumbered Publication.
- (2-21) ———
1941. *Computed Thermal Conductivity of Common Woods*. Technical Note No. 248.

- (2-22) FOREST PRODUCTS LABORATORY.
1941. *Moisture Content—Strength Adjustments for Wood*. Forest Products Laboratory Report No. 1313.
- (2-23) ———
1943. *Design of Plywood Webs in Box Beams*. Forest Products Laboratory Report No. 1318 and Supplements.
- (2-24) ———
1947. *Wood Aircraft Inspection and Fabrication*. ANC-19. (In Press).
- (2-25) FREAS, A. D.
1946. *Methods of Computing the Strength and Stiffness of Plywood Strips in Bending*. Forest Products Laboratory Report No. 1304.
- (2-26) GEORGE, H. O.
1933. *Effect of Low Temperature on the Strength of Wood*. New York State College of Forestry, Syracuse Univ. Tech. Pub. No. 43.
- (2-27) GOODELL, H. R. AND PHILLIPS, R. S.
1944. *Bolt-bearing Strength of Wood and Modified Wood: Effects of Different Methods of Drilling Bolt Holes in Wood and Plywood*. Forest Products Laboratory Report No. 1523.
- (2-28) GREENHILL, W. L.
1936. *Strength Tests Perpendicular to the Grain of Timber at Various Temperatures and Moisture Contents*. F. Coun. Sci. Ind. Res. (Aust.) Vol. 9(4):265-276.
- (2-29) ———
1942. *The Damping Capacity of Timber*. (Aust.) Jour. Coun. Sci. & Ind. Res. Vol. 15, No. 2, May 1942.
- (2-30) HEEBINK, T. B., MARCH, H. W., AND NORRIS, C. B.
1946. *Buckling of Stiffened, Flat Plywood Plates in Compression*. Forest Products Laboratory Report No. 1553.
- (2-31) HUNT, P. J., GOODELL, H. R., AND PHILLIPS, R. S.
1946. *Bolt-bearing Strength of Wood and Modified Wood: Bearing Strength of Commercial Cross-Banded Compreg Under Aircraft Bolts*. Forest Products Laboratory Report No. 1523-B.
- (2-32) JENKIN, C. F.
1920. *Report on Materials Used in Aircraft and Aircraft Engines*. (Gr. Brit.). Munitions-Aircraft Production Department. Aeronautical Research Committee.
- (2-33) KIMBALL, A. L.
1941. *Vibration Problems*. Jour. of Applied Mechanics, Vol. 8, No. 1, March 1941, and Vol. 8, No. 3, Sept. 1941.
- (2-34) KITAZAWA, G.
1947. *Relaxation of Wood Under Constant Strain*. New York State College of Forestry, Syracuse Univ. Tech. Pub. No. 67.
- (2-35) KLOOT, N. H.
1940-1947. *Miscellaneous Investigations on Aircraft Timbers. The Variation of Toughness and Izod Values of Hoop and Bunya Pine, and Same for Other Species*. Aust., Coun. for Sci. & Ind. Res., Div. of Forest Products. Proj. TM 18-0.
- (2-36) KOLLMAN, F.
1936. *Technologie Des Holzes*. Julius Springer, Berlin.
- (2-37) ———
1940. *Die Mechanischen Eigenschaften Verschieden Feuchter Holzter in Temperaturbereich Von-200 BIS +200° C*. VDI Forschungsheft 403 B (11) 1-18, July-August 1940. Available in English as NACA Technical Memorandum No. 984, September 1941.
- (2-38) KOMMERS, W. J.
1943. *The Fatigue Behavior of Wood and Plywood Subjected to Repeated and Reversed Bending Stresses*. Forest Products Laboratory Report No. 1327.
- (2-39) ———
1944. *Supplement to the Fatigue Behavior of Wood and Plywood Subjected to Repeated and Reversed Bending Stresses*. Forest Products Laboratory Report No. 1327-A.
- (2-40) KUENZI, E. W.
1947. *Stability of a Few Curved Panels Subjected to Shear*. Forest Products Laboratory Report No. 1571.
- (2-41) LEWIS, W. C.
1946. *Fatigue of Wood and Glued Wood Constructions*. Proc. Amer. Soc. Test. Matl. Vol. 46: 814-35.
- (2-42) ———, HEEBINK, T. B., AND COTTINGHAM, W. S.
1945. *Effect of Increased Moisture Content on the Shear Strength at Glue Lines of Box Beams and on the Glue-Shear and Glue-Tension Strength of Small Specimens*. Forest Products Laboratory Report No. 1551.
- (2-43) LISKA, J. A.
1946. *Methods of Calculating the Strength and Modulus of Elasticity of Plywood in Compression*. Forest Products Laboratory Report No. 1315.
- (2-44) MCBURNEY, R. S., DOYLE, D. V., AND DROW, J. T.
1946. *The Elastic Properties of Wood*. Forest Products Laboratory Report No. 1528-D, F.
- (2-45) McLEAN, J. D.
1941. *Thermal Conductivity of Wood*. Trans. Amer. Soc. of Heating and Vent. Engr. Vol. 47: 323-354.
- (2-46) ———
1945. *Effect of Heat on the Properties and Serviceability of Wood—Experiments on Thin Wood Specimens*. Forest Products Laboratory Report No. R1471.

- (2-47) McLEOD, A. M.
1946. *Bolt-Bearing Strength of Wood and Modified Wood: Bearing Strength of Commercial Aircraft Plywood Under Aircraft Bolts*. Forest Products Laboratory Report No. 1523-C.
- (2-48) ———, YOLTON, L. A., SANBORN, W. A., AND PHILLIPS, R. S.
1945. *A Comparison of Shearing Strengths of Glued Joints of Various Grain Directions as Determined by Four Methods of Test*. Forest Products Laboratory Report No. 1522.
- (2-49) McNAUGHTON, G. C.
1944. *Ignition and Charring Temperatures of Wood*. Forest Products Laboratory Report No. R1464.
- (2-50) MARCH, H. W.
1942. *Buckling of Flat Plywood Plates in Compression, Shear, or Combined Compression and Shear*. Forest Products Laboratory Report No. 1316 and Supplements.
- (2-51) ———
1942. *Flat Plates of Plywood under Uniform or Concentrated Loads*. Forest Products Laboratory Report No. 1312.
- (2-52) ———
1944. *Rectangular Plywood Plates with the Grain of the Face Plies Inclined to the Edges*. Forest Products Laboratory Report No. 1507.
- (2-53) ———
1944. *Stress-Strain Relations in Wood and Plywood Considered as Orthotropic Materials*. Forest Products Laboratory Report No. 1503.
- (2-54) ———, KUENZI, E. W., AND KOMMERS, W. J.
1942. *Methods of Measuring the Shearing Moduli in Wood*. Forest Products Laboratory Report No. 1301.
- (2-55) ——— AND SMITH, C. B.
1945. *Buckling of Flat Sandwich Panels in Compression*. Forest Products Laboratory Report No. 1525.
- (2-56) MARKWARDT, L. J.
1938. *Form Factors and Methods of Calculating the Strength of Wooden Beams*. Forest Products Laboratory Report No. R1184.
- (2-57) ——— AND WILSON, T. R. C.
1935. *Strength and Related Properties of Woods Grown in the United States*. U. S. Dept. Agr. Tech. Bull. 479.
- (2-58) MEYAL, K. AND OSHAWA, M.
——— *Experiments in the Bending Strength of Frozen Wood*. Research Bull., Hokkaido Imp. Univ., Sapporo, Japan. (Text in Japanese.)
- (2-59) NATIONAL ADVISORY COMMITTEE FOR AERONAUTICS
1923. *Deflection of Beams with Special Reference to Shear Deformations*. Report No. 180.
- (2-60) NAYER, A. N.
1948. *Swelling of Wood in Various Organic Liquids*. Ph.D. Thesis, Univ. of Minn., March 1948.
- (2-61) NEWLIN, J. A.
1939. *Bearing Strength of Wood at an Angle to the Grain*. Engineering News-Record, May 11, 1939.
- (2-62) ——— AND TRAYER, G. W.
1923. *Form Factors of Beams Subjected to Transverse Loading Only*. N. A. C. A. Tech. Report No. 181 (Also, Forest Products Laboratory Report No. 1310).
- (2-63) ——— AND TRAYER, G. W.
1924. *Stresses in Wood Members Subjected to Combined Column and Beam Action*. N. A. C. A. Tech. Report No. 188 (Also, Forest Products Laboratory Report No. 1311).
- (2-64) ——— AND TRAYER, G. W.
1930. *Design of Airplane Wing Ribs*. N. A. C. A. Tech. Report 345 (Also, Forest Products Laboratory Report No. 1307).
- (2-65) NORRIS, C. B.
1943. *The Application of Mohr's Stress and Strain Circles to Wood and Plywood*. Forest Products Laboratory Report No. 1317.
- (2-66) ——— AND KOMMERS, W. J.
1943. *Plastic Flow (Creep) Properties of Two Yellow Birch Plywood Plates Under Constant Shear Stress*. Forest Products Laboratory Report No. 1324.
- (2-67) ——— AND MCKINNON, P. F.
1946. *Compression, Tension, and Shear Tests on Yellow-poplar Plywood Panels of Sizes That Do Not Buckle with Tests Made at Various Angles to the Face Grain*. Forest Products Laboratory Report No. 1328 and Supplements 1328-A, 1328-B, and 1328-C.
- (2-68) SANBORN, W. A., GOODELL, H. R., ELY, A. W., AND PHILLIPS, R. S.
1946. *Bolt-Bearing Strength of Wood and Modified Wood: Bearing Strength of Wood Members Reinforced With Plywood and Cross-Banded Compreg Under Single and Multiple Aircraft Bolts*. Forest Products Laboratory Report No. 1523-D.
- (2-69) SMITH, C. B.
1944. *Effect of Elliptic or Circular Holes on the Stress Distribution in Plates of Wood or Plywood Considered as Orthotropic Materials*. Forest Products Laboratory Report No. 1510.
- (2-70) NORRIS, C. B. AND RINGELSTETTER, L. A.
1948. *Buckling of Stiffened, Flat, Plywood Plates in Compression*. Forest Products Laboratory Report No. 1553-C.
- (2-71) SMITH, C. B., HEEBINK, T. B., AND NORRIS, C. B.
1946. *The Effective Stiffness of a Stiffener Attached to a Flat Plywood Plate*. Forest Products Laboratory Report No. 1557.

- (2-72) STAMM, A. J.
1930. *An Electrical Conductivity Method for Determining the Moisture Content of Wood*. Forest Products Laboratory Report No. R1023.
- (2-73) SULZBERGER, P. H.
1943. *The Effect of Temperature on the Strength Properties of Wood, Plywood, and Glued Joints*. Jour. Coun. Sci. & Ind. Res. (Aust.). Vol. 16, (4): 263-265.
- (2-74) TAYLOR, J. P.
1943. *Heating Wood with Radio Frequency Power*. Trans. Am. Soc. Mech. Engr. Vol. 56, No. 3, April 1943.
- (2-75) TIEMANN, H. D.
1944. *Wood Technology*. Pitman Publishing Co.
- (2-76) THUNELL, B.
1940. *The Effect of Temperature on the Bending Strength of Swedish Pinewood*. Abst. Empire Forestry Jour. Vol. 19 (1940) P. 309.
- (2-77) TRAYER, G. W.
1928. *Bearing Strength of Wood Under Steel Aircraft Bolts and Washers and Other Factors Influencing Fitting Design*. N. A. C. A. Tech. Note 296.
- (2-78) ———
1930. *Wood in Aircraft Construction*. National Lumber Manufacturers Association.
- (2-79) ——— AND MARCH, H. W.
1931. *Elastic Instability of Members Having Sections Common in Aircraft Construction*. N. A. C. A. Tech. Report No. 382.
- (2-80) UNDERWRITERS' LABORATORIES
1940. *Wood, Ignition of at Low Temperatures*. Card Data Service Serial No. UL198.
- (2-81) VORREITER, L.
1938. *Biege- und Druckfestigkeit Gefrorenen Fichtenholtzels*. Tharandierforstl. Jrb. 89:-491-510.
- (2-82) WEATHERWAX, R. C., AND STAMM, A. J.
1946. *Coefficient of Thermal Expansion of Wood and Wood Products*. Amer. Soc. Mech. Engin. Trans. 69(44):421-432.
- (2-83) ——— AND STAMM, A. J.
1943. *The Electrical Resistivity of Resin-Treated Wood (Impreg and Compreg), Hydrolyzed Wood Sheet (Hydroxylin) and Laminated Resin-Treated Paper*. Forest Products Laboratory Report No. 1385.
- (2-84) WILSON, T. R. C.
1930. *Effect of Creosote on Strength of Fir Timbers*. Timberman 31(8):50-56.
- (2-85) ———
1932. *Strength-Moisture Relations for Wood*. U. S. Dept. Agr. Tech. Bull. 282.
- (2-86) WOOD, L. W.
1947. *Behavior of Wood Under Continued Loading*. Engineering News-Record, Dec. 11, 1947, pp. 108-111.
- (2-87) FULLER AND OBERG
1943. *Fatigue Characteristics of Natural and Resin Impregnated, Compressed, Laminated Woods*. J. Aeronautical Science, Vol. 10, March 1943, p. 81.
- (2-88) NORRIS, C. B., WERREN, F., AND MCKINNON, P. F.
1948. *The Effect of Veneer Thickness and Grain Direction on the Shear Strength of Plywood*. Forest Products Laboratory Report No. 1801.
- (2-89) NORRIS, C. B., KOMMERS, W. J., AND MCKINNON, P. F.
1948. *Critical Buckling Strength of Stiffened Flat Plywood Plates in Compression and Shear—Closely Spaced Stiffeners*. Forest Products Laboratory Report No. 1800.
- (2-90) MARCH, H. W., NORRIS, C. B., AND KUENZI, E. W.
1943. *Buckling of Long, Thin Plywood Cylinders in Axial Compression*. Forest Products Laboratory Report No. 1322 and supplements.
- (2-91) KUENZI, E. W.
1948. *Effect of Length on the Buckling Stresses of Thin-walled Plywood Cylinders in Axial Compression*. Forest Products Laboratory Report No. 1514.
- (2-92) ———
1944. *Thin-walled Plywood Cylinders in Bending*. Forest Products Laboratory Report No. 1502.
- (2-93) MARCH, H. W., NORRIS, C. B., SMITH, C. B., AND KUENZI, E. W.
1945. *Buckling of Thin-walled Plywood Cylinders in Torsion*. Forest Products Laboratory Report No. 1529.
- (2-94) KUENZI, E. W.
1944. *Thin-walled Plywood Cylinders in Bending and Torsion*. Forest Products Laboratory Report No. 1501.
- (2-95) KUENZI, E. W., AND NORRIS, C. B.
1948. *Longitudinally Stiffened Thin-walled Cylinders in Axial Compression*. Forest Products Laboratory Report No. 1562.
- (2-96) ———
1948. *Torsional Buckling of Longitudinally Stiffened, Thin-walled, Plywood Cylinders*. Forest Products Laboratory Report No. 1563.
- (2-97) NEWLIN, J. A., AND GAHAGAN, J. M.
1930. *Tests of Large Timber Columns and Presentation of the Forest Products Laboratory Column Formula*. U. S. Dept. Agr. Tech. Bull. 167.

BIBLIOGRAPHY FOR CHAPTER 2

ELMENDORF, A.

1920. *Data on the Design of Plywood for Aircraft*. N. A. C. A. Tech. Report 84. (Also Forest Products Laboratory Report No. 1302).

1941. *Specific Gravity-strength Relations for Wood*. Forest Products Laboratory Report No. 1303.

1947. *Wood Aircraft Inspection and Fabrication*. ANC-19 (On Press).

LEWIS, W. C. AND DAWLEY, E. R.

1943. *Stiffeners in Box Beams and Details of Design*. Supplement to: Design of Plywood Webs in Box Beams. Forest Products Laboratory Report No. 1318-A.

—; HEEBINK, T. B.; COTTINGHAM, W. S.; AND DAWLEY, E. R.

1943. *Buckling in Shear Webs of Box and I-Beams and the Effect Upon Design Criteria*. Supplement to: Design of Plywood Webs in Box Beams. Forest Products Laboratory Report No. 1318-B.

LUNDQUIST, E. E.; KOTANCHIK, J. N.; AND ZENDER, G. W.

1942. *A Study of the Compressive Strength of Stiffened Plywood Panels*. N. A. C. A. Advanced Tech. Note (Restricted).

MARCH, H. W.

1941. *Summary of Formulas for Flat Plates of Plywood Under Uniform or Concentrated Loads*. Forest Products Laboratory Report No. 1300 (Revised).

1943. *Buckling of Long, Thin Plywood Cylinders in Axial Compression*. Forest Products Laboratory Report No. 1322 and supplements 1322-A and 1322-B.

MARKWARDT, L. J.

1930. *Aircraft Woods: Their Properties, Selection, and Characteristics*. N. A. C. A. Tech. Report 354. (Also Forest Products Laboratory Report No. R1079).

NEWLIN, J. A.

1940. *Formulas for Columns with Side Loads and Eccentricity*. Building Standards Monthly, December 1940.

NORRIS, C. B.

1937. *The Technique of Plywood*. Hardwood Record, October 1937 to March 1938.

TRAYER, G. W.

1930. *The Design of Plywood Webs for Airplane Wing Beams*. N. A. C. A. Tech. Bull. 344.

1932. *The Bearing Strength of Wood Under Bolts*. U. S. Dept. Agr. Tech. Bull. 332.

CHAPTER 3

METHODS OF STRUCTURAL ANALYSIS

3.0. General

3.00. PURPOSE. It is the purpose of the Methods of Structural Analysis portion of this bulletin to present acceptable procedures for use in determining the internal stresses resulting from the application of known external loads to wood and plywood aircraft structures. The basic design procedures that have been developed for use in analyzing metal structures are generally applicable to the problem of wood structures provided that suitable modifications are made to account for the differences in physical characteristics. The designer's attention is directed to existing text material covering the treatment of common stress-analysis problems not treated herein, and to the current preparation of an Army-Navy-Civil Bulletin, ANC-4 "Methods of Structural Analysis."

It is to be emphasized that the analysis procedures described in this bulletin are not presented as required procedures but represent suggested methods that are acceptable to the Army, Navy, and Civil Aeronautics Administration. The nature, magnitude, and distribution of the loads for which the airplane structure shall be designed are defined by the applicable specification, regulation, handbook, or bulletin of the procuring or certifying agency.

Submission of a stress analysis, although such an analysis employs a method of procedure which is considered acceptable by the procuring or certifying agency, does not necessarily constitute satisfactory proof of adequate strength. The stress analysis should be supplemented by pertinent test data. Unless a structure conforms closely to a previously constructed type, the strength of which has been determined by test, a stress analysis is not considered as a sufficiently accurate and certain means of determining its strength. Most desirable is a test of the complete structure under the critical design-loads. However, tests of certain component parts and of

specimens employing generally typical construction and detail design features are of great assistance both in justifying allowable stresses and in proving analysis methods. In each individual case, the extent and nature of the structural test program required to substantiate the stress analysis is specified by the procuring or certifying agency.

3.01. SPECIAL CONSIDERATIONS IN STATIC TESTING OF STRUCTURES. Since the allowable stress values given in chapter 2, tables 2-6 and 2-7, are based on a definite moisture content and method of load application, consideration should be given to these variables, both in using element tests to establish design allowable stresses and in designing structures to be statically tested as complete structures. Elements include simple structural members and details, such as panels, stiffened panels, or sections of spars. Complete structures include wing panels, center sections, fuselage, stabilizer, or other parts individually or in combination. These two types of test will be discussed separately since they are treated differently.

3.010. *Element Tests.* A comparison of the design values listed in tables 2-6 and 2-7 with the results of standard tests at 12 percent moisture content (ref. 2-57) shows that test results may be made approximately comparable to the design values by the following methods. Enough tests should be made to cover variability but the required number will be governed by various factors as discussed in the following.

Case A. When the type of element and the mode of failure are such that the results of element tests can be directly related to the physical properties of coupons cut from the materials used in the elements, the results of element tests may be corrected by the ratio of the design values in tables 2-6 and 2-7 to the test coupon values. Care should be taken that the elements and the coupons are tested at a slow rate, at the same

moisture content, and under approximately the same time-loading conditions. The test element should be made of matched materials; for example all stiffeners in a stiffened panel should be made from the same stock.

Case B. When it is not practicable to correct element tests by means of related tests on coupons, the following procedure may be employed:

- (1) A sufficient number of tests should be made to establish a reasonably reliable average considering the variability of the materials. Fewer tests will be required and the scatter of related tests will be reduced if the test results are corrected to the average specific gravity values listed in tables 2-6 and 2-7 by the methods of section 2.01. For the same reason, it is desirable to use material of approximately average specific gravity in test specimens.
- (2) The strength should be adjusted to 12 percent moisture by factors from table 2-2 appropriate to the primary mode of failure. Should failure occur in glued or bolted fastenings, however, no upward adjustments should be made. It should be recognized that moisture adjustments are subject to error and should, therefore, be avoided whenever possible by conditioning test specimens to approximately 12 percent moisture content.
- (3) In element tests it will usually be possible to arrange the test procedure so that errors due to rate and duration of load will be negligible in comparison with other experimental errors, for example:
 - (a) If the maximum load is supported for 15 seconds or more, such as in tests where the load is added by weight increments, corrections for rate and duration of load are unnecessary.
 - (b) If the specimen is loaded at a rate of strain such that the time from zero load to failure is more than 2 minutes when the testing machine is operated continuously, corrections are unnecessary. Thus, if the first stopping point is 25 percent of the expected ultimate load and the machine takes $\frac{1}{2}$ minute to reach this load, the rate of strain is sufficiently low.

The time to failure after passing the limit load should be not more than 5

minutes if possible (slower loading results in lower ultimate loads) since upward corrections of test values, because of long duration, are considered inadvisable.

- (4) After correction of the average test results for moisture, a correction factor to allow for variability should be applied as follows:
 - (a) 0.94 when the failure is principally the result of compression, tension, or bending stresses, or shear in 45° plywood.
 - (b) 0.80 when the failure is principally due to shear stresses parallel to the grain.

3.011. *Complete structures.*

3.0110. *Design allowances for test conditions.*

When a complete structure is static tested, it is not usually possible to make the test under the conditions on which the design values of tables 2-6 and 2-7 are based. Therefore, if the purpose of the test is to prove the strength of the entire structure at a specified ultimate load regardless of test conditions (which is usually the case in order to prove joints and fittings) it is recommended that the designer investigate the effects of probable test conditions prior to designing the structure on the basis of tables 2-6 and 2-7.

If it appears that the probable test conditions will cause the strength in the test to be less than that corresponding to design values in tables 2-6 and 2-7 suitable margins of safety should be incorporated during the design.

3.0111. *Test procedure.* In complex composite structures the effects of moisture content on overall strength are uncertain. Changes in wood strength may be offset by stress concentration effects. It is, therefore, desirable that complete structures be conditioned as closely as possible to 12 percent moisture content at the time of testing.

To minimize effects of rate and duration of load, the time to failure after passing limit load should be less than 15 minutes if possible.

The ultimate load should be sustained without failure for at least 15 seconds, in order to insure the test being comparable to design values in regard to time effects.

The above procedure may be varied depending upon the purpose of the test. Agreement should be reached with the procuring or certifying agency regarding the test procedures and methods of correction, if any, prior to conducting major tests.

3.1. Wings

3.10. GENERAL. Because of the basic differences in their structural behavior, separate stress analysis procedures are outlined for the following general types of wing structures:

- (a) Two-spar wings with independent spars.
- (b) Reinforced shell wings.

3.11. TWO-SPAR WINGS WITH INDEPENDENT SPARS. The methods of analysis presented under this heading are based on the assumption that the spars deflect independently in bending. Such methods are particularly applicable to two-spar fabric-covered wings with drag bracing in a single plane. They may also be applied to two-spar wings having drag bracing in two planes. In such cases, the effect of the torsional rigidity resulting from the double drag bracing, tending to equalize the deflections of the two spars, is usually neglected but may be taken into account by the methods of reference 3-7.

3.110. Spar loadings. The following method of determining the running loads on the spars has been developed to simplify the calculations required and to provide for certain features which cannot be accounted for in a less general method. It is equivalent to assuming that the resultant air and inertia loads at each section are divided between the spars as though the ribs were simple beams and the spars furnished the reactions. Frequently, certain items are constant over the span; then the computations are considerably simplified.

The net running load on each spar, in pounds per inch run, can be obtained from the following equations:

$$y_f = \left[\{ C_N (r-a) + C_{M_a} \} q + n_2 e (r-j) \right] \frac{C'}{144 b} \quad (3:1)$$

$$y_r = \left[\{ C_N (a-f) - C_{M_a} \} q + n_2 e (j-f) \right] \frac{C'}{144 b} \quad (3:2)$$

where:

y_f = net running load on front spar, in pounds per inch

y_r = net running load on rear spar, in pounds per inch

$a, b, f, j,$ and r are shown in figure 3-1 and are all expressed as fractions of the chord at the station in question. The value of a must agree with the value on which C_{M_a} is based.

q = dynamic pressure for the condition being investigated.

C_N and C_{M_a} are the airfoil normal force and moment coefficients, respectively, at the section in question.

C' is the wing chord, in inches.

e is the average unit weight of the wing, in pounds per square foot, over the chord at the station in question. It should be computed or estimated for each area included between the wing stations investigated, unless the unit wing weight is substantially constant, in which case a constant value may be assumed. By properly correlating the values of e and j , the effects of local weights, such as fuel tanks and nacelles, can be directly accounted for.

n_2 is the net limit-load factor representing the inertia effect of the whole airplane acting at the center of gravity. The inertia load always acts in a direction opposite to the net air load. For positively accelerated conditions n_2 will always be

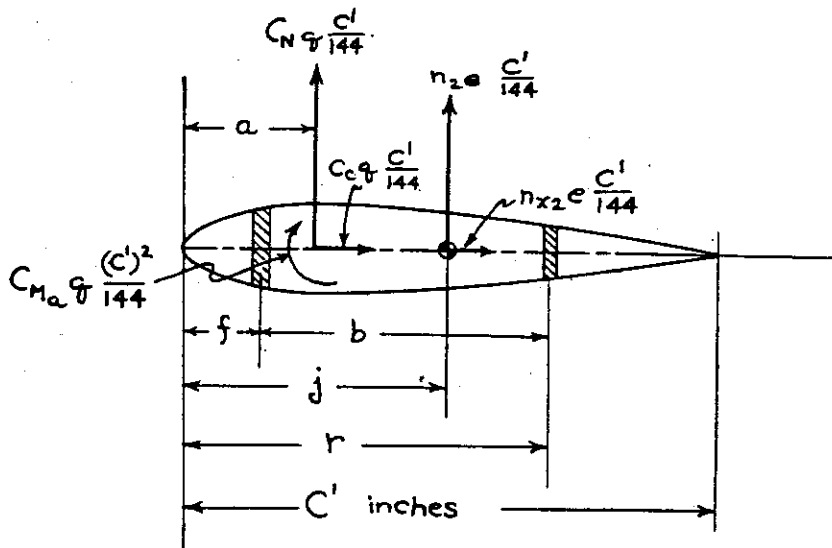

Figure 3-1. Unit section of a conventional 2-spar wing. All vectors are shown in positive sense.

Table 3-1. Computation of net unit loadings (constants)

	Stations Along Span				
1	Distance from root, inches				
2	$C'/144 = (\text{chord in inches}) / 144$				
3	f , fraction of chord				
4	r , " " "				
5	$b = r - f = \textcircled{4} - \textcircled{3}$				
6	a , fraction of chord (a.c.)				
7	j , " " " *				
8	$e = \text{unit wing wt., lbs/sq.ft.}^*$				
9	$r - a = \textcircled{4} - \textcircled{6}$				
10	$a - f = \textcircled{6} - \textcircled{3}$				
11	$r - j = \textcircled{4} - \textcircled{7}$				
12	$j - f = \textcircled{7} - \textcircled{3}$				
13	$C'/144 b = \textcircled{2} / \textcircled{5}$				

* These values will depend on the amount of disposable load carried in the wing.

negative, and vice versa. Its value and sign are obtained in the balancing of the airplane.

If it is desired to compute the airloading and inertia loadings separately, formulas (3:1) and (3:2) may be modified by omitting terms containing n_2 for the airloading, and omitting terms containing q for the inertia loading. Then the inertia loading, shear, and moment curves need be computed for only one condition (say, $n_2=1.0$), the values for any other condition being obtained by multiplying by the proper load factor.

The computations required in using the preceding method are outlined in tables 3-1 and 3-2, in a form which is convenient for making calculations and for checking.

The following modifications and notes apply to tables 3-1 and 3-2:

(a) When the curvature of the wing tip prevents the spars from extending to the extreme tip of the wing, the effect of the tip loads on the spar can easily be accounted for by extending the spars to the extreme span as hypothetical members. In such cases, the dimension f will become negative, as the leading edge will lie behind the hypothetical front spar.

(b) The local values of C_N , item 14, are

determined from the design values of C_N in accordance with the proper span-distribution curve.

(c) Item 15 provides for a variation in the local value of C_M . When a design value of center-of-pressure coefficient is specified, the value of C_M should be determined by the following equation, using item numbers from tables 3-1 and 3-2.

$$C'_{M_a} = \textcircled{14} [\textcircled{6} - CP'] \quad (3:3)$$

(d) When conditions with deflected flaps are investigated, the value of C_{M_a} over the flap portion should be properly modified. For most conditions, C_{M_a} will have a constant value over the span.

(e) The gross running loads on the wing structure can be obtained by assuming e to be zero; then, items $\textcircled{19}$, $\textcircled{25}$, and $\textcircled{30}$ become zero, y_r becomes $\textcircled{18} \times \textcircled{13}$, y_l becomes $\textcircled{24} \times \textcircled{13}$, and y_c becomes $\textcircled{29} \times \textcircled{2}$.

3.111. *Chord loading.* The net chord loading, in pounds per inch run, can be determined from the following equation:

$$y_c = \frac{[C_c q + n_{r2} e] C'}{144} \quad (3:4)$$

Table 3-2. Computation of net unit loadings (variables)

CONDITION ----					
q	$C_{N1}(\sigma)$	$C'c$	C'_M or C.P.I	n_a	n_{a2}
	(Refer also to Table 3-4)		Distance b from root		
	14	C_{N_b} = (variation with span)			
	15	C_{M_a} (variation with span)			
Front Spar	16	(14) x (9)			
	17	(16) + (15)			
	18	(17) x q			
	19	n_a x (8) x (11)			
	20	(18) + (19)			
	21	y_f = (20) x (13), lbs/inch			
Rear Spar	22	(14) x (10)			
	23	(22) - (15)			
	24	(23) x q			
	25	n_a x (8) x (12)			
	26	(24) + (25)			
	27	y_r = (26) x (13), lbs/inch			
Chord Load	28	C'_c (variation with span)			
	29	(28) x q			
	30	n_{a2} x (8)			
	31	(29) + (30)			
	32	y_o = (31) x (2), lbs/inch			

where:

y_c = running chord load, in pounds per inch.

C_c = airfoil chord force coefficient at each station. The proper sign should be retained throughout the computations.

n_{a2} = net limit chord-load factor approximately representing the inertia effect of the whole airplane in the chord direction. The value and sign are obtained in the balancing of the airplane. When C_c is negative, n_{a2} will be positive.

q, e, and C' are the same as in section 3.110.

The computations for obtaining the chord load are outlined in table 3-2, items 28 to 32. The following points should be noted:

(a) The value of C_c , item 28, usually can be assumed to be constant over the span. The only variation required is in the case of partial-span wing flaps or similar devices.

(b) The relative location of the wing spars and drag truss will affect the drag-truss

loading produced by the chord and normal air forces. This can easily be accounted for by correcting the value of C_c (sec. 3.1121).

It is often necessary to consider the local loads produced by the propeller thrust and by the drag of items attached to the wing. The drag of nacelles built into the wing is usually so small that it safely can be neglected. The drag of independent nacelles and that of wing-tip floats can be computed by using a rational drag coefficient or drag area in conjunction with the design speed. In general, the effects of nacelles or floats can be computed separately and added to the loads obtained in the design conditions.

3.112. Lift-truss analysis.

3.1120. General. In considering a lift-truss system for either a monoplane or a biplane and,

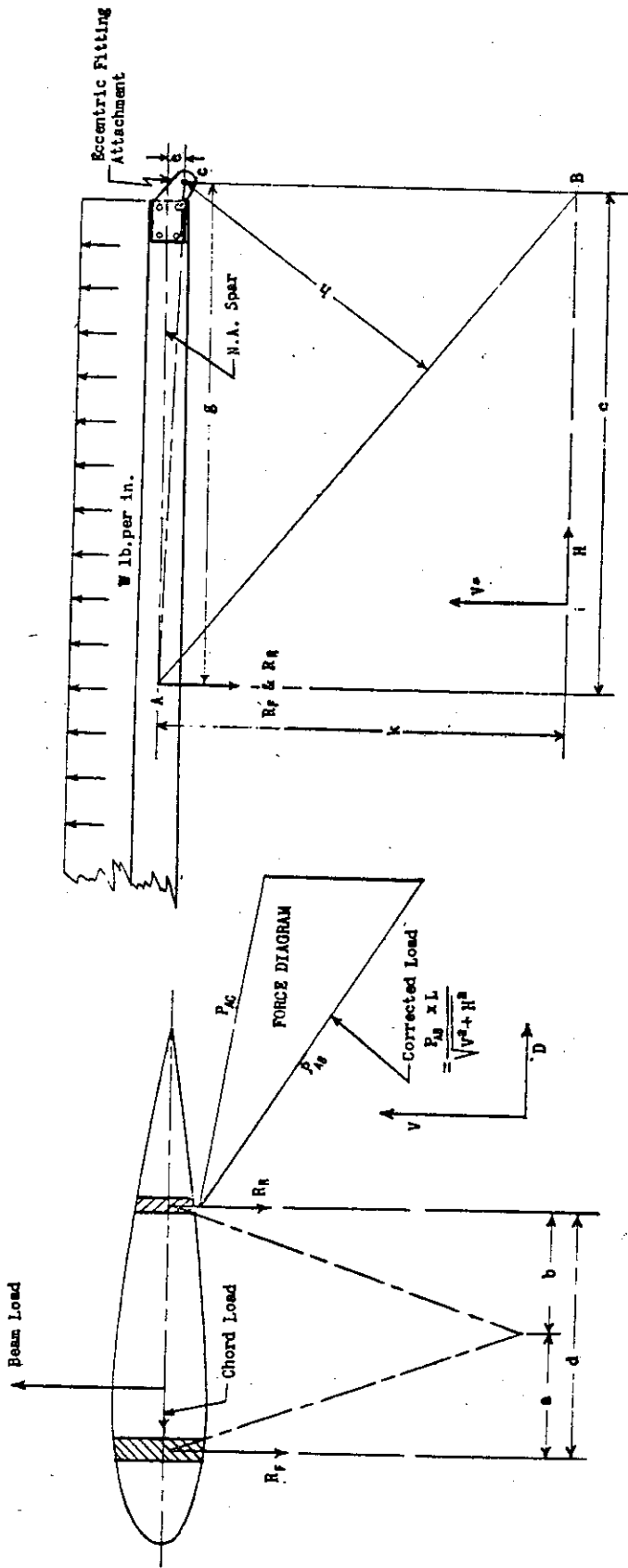

* For simplicity V and H axis taken perpendicular and parallel to spar N.A. respectively.

Member	V	H	D	V ²	H ²	D ²	L ² = V ² + D ² + H ²	L	Proj. length V-H plane
Front Strut	k	o	a	k ²	o ²	a ²	k ² + o ² + a ²	$\sqrt{k^2 + o^2 + a^2}$	$\sqrt{k^2 + o^2}$
Rear Strut	k	c	b	k ²	c ²	b ²	k ² + c ² + b ²	$\sqrt{k^2 + o^2 + b^2}$	$\sqrt{k^2 + c^2}$

Figure 3-2. Strut-braced monoplane.

in the subsequent investigation of the drag-truss system, due attention should be given to all the force components which will be applied to the attachment points by the lift truss.

3.1121. *Lift struts.* Consider the strut-braced monoplane wing shown in figure 3-2. The spars in the figure are shown perpendicular to the basic wing chord (the reference line for normal and chord loads is the M. A. C. of the wing). If the spars are not perpendicular to the chord reference line, the resultant of the chord and normal loads should be resolved into components parallel and normal to the spar, as shown in figure 3-3a. Also, in the general case, the drag truss will not be perpendicular to the spar face. This angularity should be considered (fig. 3-3b), unless it is of small order, which would result in a negligible correction.

The vertical reactions on the front and rear spars from the lift struts may be determined by taking moments about point C (fig. 3-2) of all the external loads on the spars (sec. 3.114).

Then $R_f = \frac{M_{cf}}{g}$; and $R_r = \frac{M_{cr}}{g}$, where M_{cf} and M_{cr} are the moments about the spar-root attachment, point C, of the front and rear spars, respectively.

The strut and spar axial loads may be determined by graphical or analytical methods on the basis of the truss A B C, if the fitting is eccentric to the neutral axis of the spar. If the graphical method is used, the correction for angularity of the strut to the V-H plane should not be overlooked.

The strut loads also can be determined by the following formula, which includes the correction for angularity:

$$\text{Strut load} = \frac{M}{h} \times \frac{\text{true length}}{\text{projected length in V-H plane}} \quad (3:5)$$

After the loads in the struts have been determined, the axial load in each spar is: (strut load) $\times \left(\frac{H}{L}\right)$ and the chord component acting on the wing from each strut is: (strut load) $\times \left(\frac{D}{L}\right)$.

When an eccentricity, e , in the root fitting exists, the chord loads and reactions will act in a plane which generally is not parallel to the line AC. The effect of the eccentricity is to modify the vertical reactions at the strut point and root.

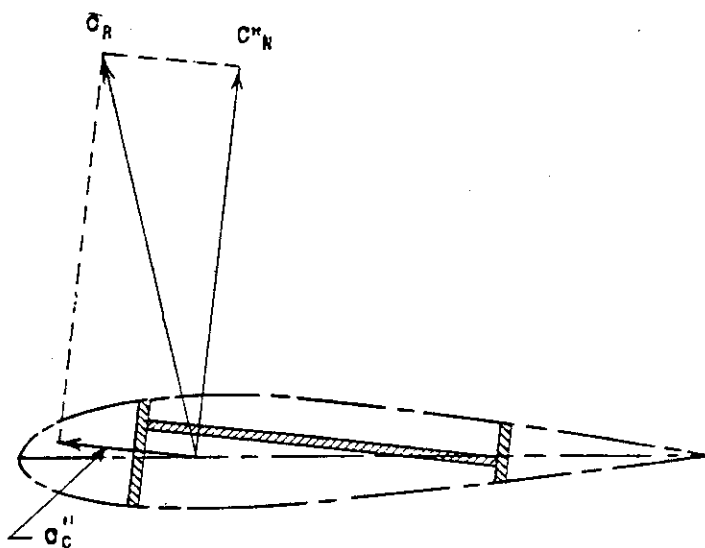

(a) DRAG TRUSS PERPENDICULAR TO SPAR FACE

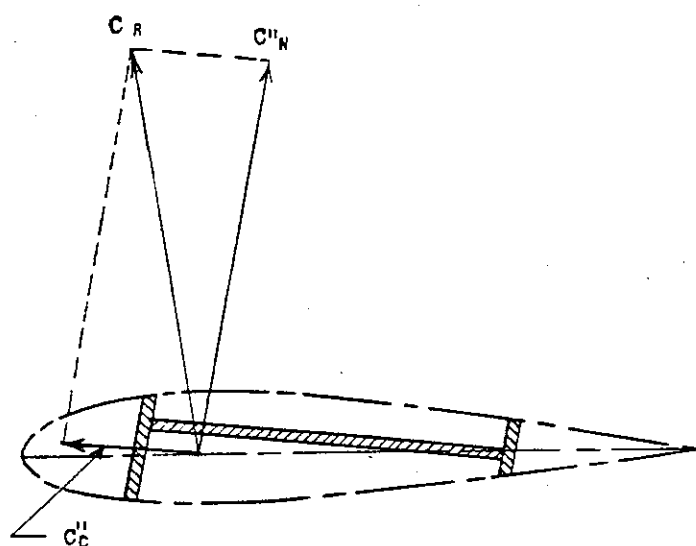

(b) DRAG TRUSS NOT PERPENDICULAR TO SPAR FACE

Figure 3-3. Resolution of forces into components acting on spars and drag truss.

The increment of reaction to be added or subtracted is: $\Delta R = \frac{R_n e}{g}$ (fig. 3-4d). Then, the total vertical reaction component at the strut point is $R + \Delta R$. It is, at once, apparent that the value of the drag-truss reaction, R_n , is a function of the strut load (fig. 3-4c); therefore, if extreme accuracy is desired, it becomes necessary to solve for the reactions on the lift and drag truss by means of simultaneous equations which include expressions for all the unknowns involved. The reactions

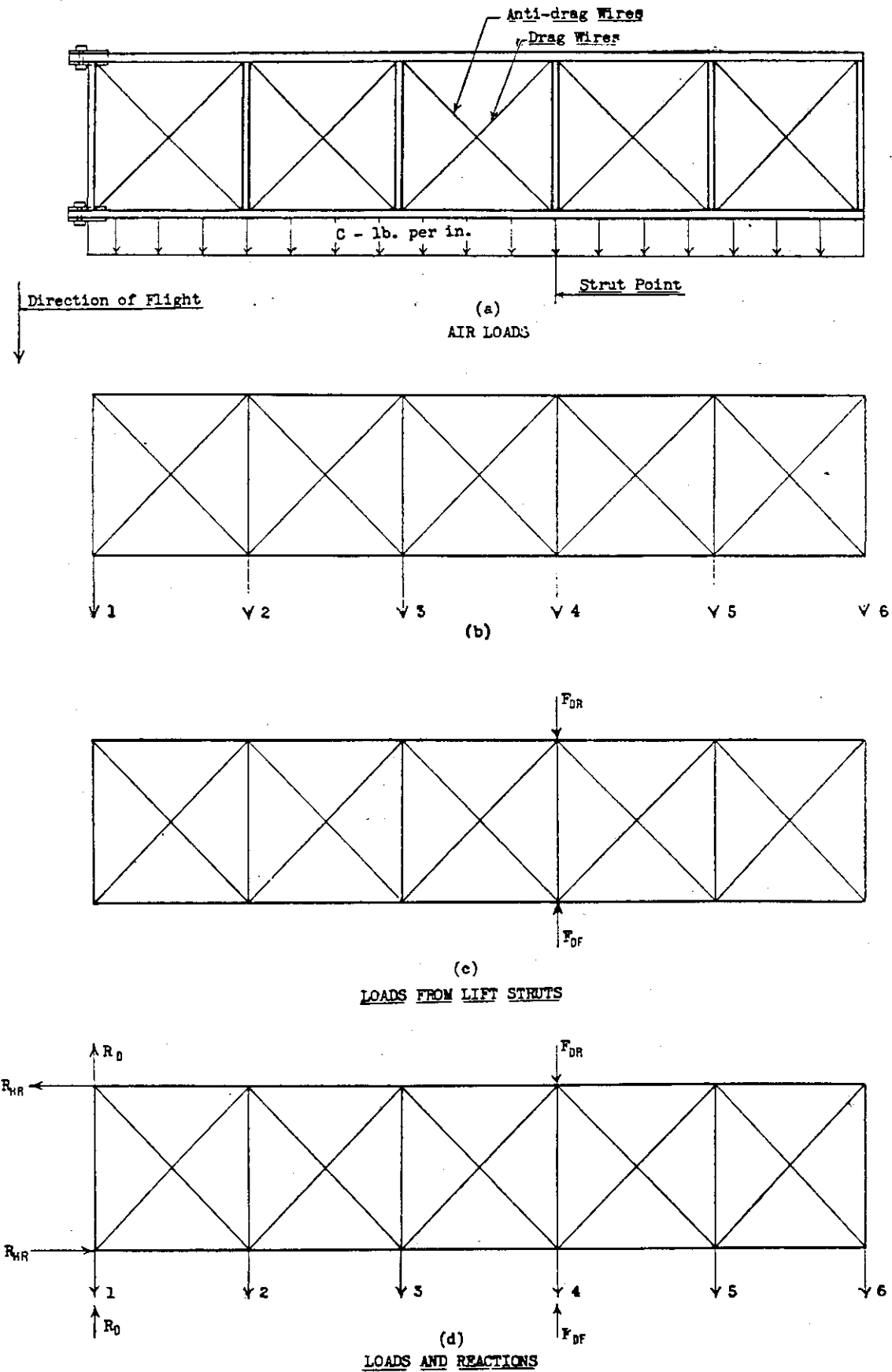

Figure 3-4. Drag truss.

may also be determined by trial and error with comparable results if sufficient trials are made. However, unless the value of ΔR is in excess of 2 percent of R , it is considered satisfactory to assume that the total reaction is $R + \Delta R$.

3.1122. *Jury struts.* In computing the compressive strength of lift struts which are braced by a jury strut attached to the wing, it is usually satisfactory to assume that a pin-ended joint exists in the lift strut at the point of attachment of the jury strut. The jury strut itself should be investigated for loads imposed by the deflection of the main wing structure. An approximate solution based on relative deflections is satisfactory, if the jury strut is conservatively designed to withstand vibration of the lift strut. When the jury strut is considered as a point of support in the wing-spar analysis, rational analysis of the entire structure should be made (ref. 3-17).

3.1123. *Nonparallel wires.* When two or more wires are attached to a common point on the wing, but are not parallel, the distribution of load between the wires may be determined by least work or equivalent methods. The following approximate equations may be used for determining the load distribution between wires, provided the loads so obtained are increased 25 percent.

$$P_1 = \left[\frac{V_1 A_1 L_1 L_2^3}{V_1^2 A_1 L_2^3 + V_2^2 A_2 L_1^3} \right] B \quad (3:6)$$

$$P_2 = \left[\frac{V_2 A_2 L_1^3 L_2}{V_1^2 A_1 L_2^3 + V_2^2 A_2 L_1^3} \right] B \quad (3:7)$$

where:

B = beam component of load to be carried at the joint.

P_1 = load in wire 1.

P_2 = load in wire 2.

V_1 = vertical length component of wire 1.

V_2 = vertical length component of wire 2.

A_1 and A_2 represent the areas of the respective wires.

L_1 and L_2 represent the lengths of the respective wires.

The chord components of the air loads and the unbalanced chord components of the loads in interplane struts and lift wires at their point of attachment to the wing should then be assumed to be carried entirely by the internal drag truss.

3.1124. *Biplane lift trusses.* In biplanes that have two complete lift-truss and drag-truss systems interconnected by an N strut, a twisting moment applied to the wing cellule will be resisted

in an indeterminate manner, as each pair of trusses can supply a resisting couple. An exact solution involving the method of least work, or a similar method, can be used to determine the load distribution (ref. 3-16). For simplicity, however, it may be assumed first that all the external normal loads and torsional forces about the aerodynamic center of the cellule are resisted by the lift trusses. This assumption is usually conservative for the lift trusses, but does not adequately cover the possible loading conditions for the drag trusses. A second condition should therefore be investigated by assuming that a relatively large portion (approximately 75 percent) of the torsional forces about the aerodynamic center of the cellule are resisted by the drag trusses. In the case of a single-lift-truss biplane, the drag trusses must, of course, resist the entire moment of the air forces with respect to the plane of the lift truss.

3.1125. *Rigging loads.* Wire-braced structures should be designed for the rigging loads specified by the procuring or certificating agency. Sometimes it may be necessary to combine the rigging loads with internal loads from flight or landing conditions.

The effects of initial rigging loads on the final internal loads are difficult to predict, but, in certain cases, may be serious enough to warrant some investigation. In this connection, methods based on least work or deflection theory offer the only exact solution. Approximate methods, however, are satisfactory if based on rational assumptions. As an example, if a certain counter-wire will not become slack before the ultimate load is reached, the analysis can be conducted by assuming that the wire is replaced by a force acting in addition to the external air forces. The residual load from the counterwire can be assumed to be a certain percentage of the rated load and will, of course, be less than the initial rigging load.

3.113. *Drag-truss analysis.*

3.1130. *Single drag-truss systems.* Single drag-truss systems are employed in strut- or wire-braced wings where the ratio of the span of the overhang to the mean chord is not excessive. The requirements of the specific agency involved should be reviewed in regard to the upper limit on this value above which double-drag bracing is required.

An example of a conventional drag truss is shown in figure 3-4 for a strut-braced monoplane wing. The chord loading, C , in pounds per inch run (fig. 3-4 (a)) may be distributed to the panel

points of the truss (*b*) as concentrated loads 1, 2, 3, 4, etc. In addition to the chord loads due to air load, the lift struts also apply loads in the chord plane. In section 3.1121, the method of determining the chord components was given. These components are shown in figure 3-4 (*c*), assuming that the wing is so loaded that the lift struts are subjected to tensile loads. If items of concentrated weight, such as fuel tanks and landing gear, were not accounted for when the running chord load was computed in table 3-2, the resultant inertia loads from these items of weight should be applied to the drag truss. In figure 3-4 (*d*) are shown all the loads and reactions acting on the drag truss.

The loads in the drag-truss members may now be determined by graphical or analytical methods. Exact division of the drag reaction, R_D , on the truss is generally indeterminate, insofar as the front and rear root-spar attachments are concerned. In general, overlapping assumptions should be made, or the drag reaction conservatively assumed to be resisted entirely by one root fitting. Occasionally, the drag reaction may be divided equally between the front and rear root-spar fittings if they have approximately the same rigidity in the drag direction.

3.1131. *Double drag-truss systems.* A double drag truss is employed in cantilever wings or braced wings where it is necessary to provide additional torsional rigidity outboard of the strut point. The investigation of double-drag trusses follows the same line of procedure outlined in section 3.1130. The design of the double truss

is usually dictated by torsional rigidity requirements rather than by the actual design loads applied to the structure.

In showing compliance with requirements in which the upper drag wire in one bay and the lower drag wire in the adjacent bay are assumed in action (the remaining wires in these two bays assumed to be out of action), the loads on the strut take the form shown in figure 3-5. R_{wu} and R_{wl} represent the wire force components along the drag strut. In general, it will be necessary to balance these components in the drag direction by a reaction, $R_{wl} - R_{wu}$; then, taking moments about a convenient point, the vertical couple force R_c may be determined. Having the forces and reactions on the drag strut, the internal forces readily may be determined.

3.1132. *Fixity of drag struts.* Drag struts should be assumed to have an end-fixity coefficient of 1.0, except in cases of unusually rigid restraint, in which a coefficient of 1.5 may be used.

3.1133. *Plywood drag-truss systems.* In a two-spar, plywood-covered wing, the plywood covering, together with the drag struts, is usually depended upon to carry the chord shear. Section 3.12 gives methods of analysis of this type of structure.

3.114. *Spar shears and moments.* The fundamental principles of statics should be employed in the determination of wing-spar shears and bending moments. Before proceeding with the detailed determination of these items, it is essential, in order to avoid errors, that all the external loads and reactions be determined for the spar.

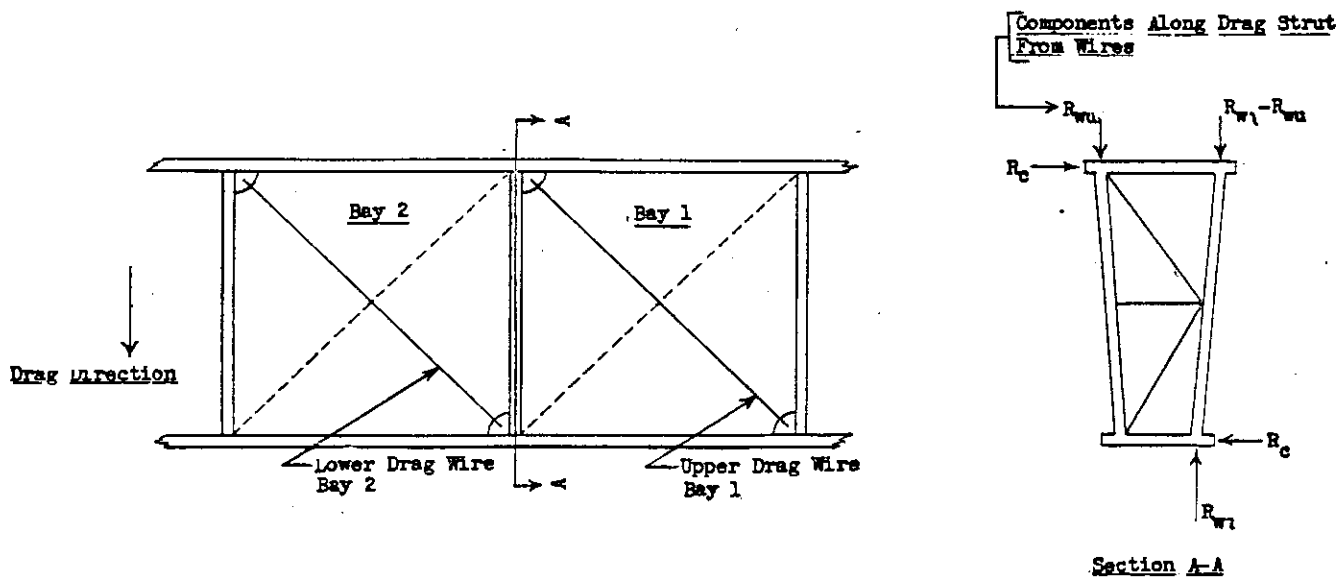
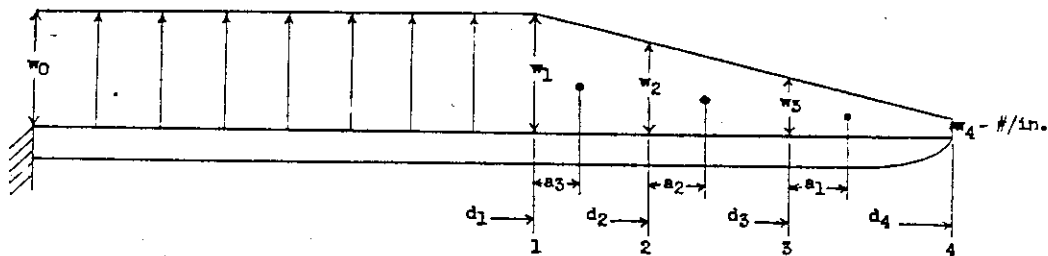

Figure 3-5. Double drag truss—two drag wires in action.



1	2	3	4	5	6	7	8	9	10	11
Section	Distance from Root	Distance between Sections d	Load per in. w	Average load per in. w_a	Load between Sections F	Arm to centroid (1)* a	Moment $M' = Fa$	Shear $S = \sum F$	Moment $M'' = Sd$	Moment at Section
4	d_4		w_4					0		0
		d_4-d_3		$\frac{w_4+w_3}{2}$	Item ⑤ x Item ⑥	(1)* a_1	(2)* F_{4-3} x a_1		0	Items ⑧ + ⑩ + ⑪
3	d_3		w_3					F_{4-3}		
		d_3-d_2		$\frac{w_3+w_2}{2}$	Item ⑤ x Item ⑥	a_2	F_{3-2} x a_2		(3)* S_3 x (d_3-d_2)	
2	d_2		w_2					$F_{4-3} + F_{3-2}$		Σ
		d_2-d_1		$\frac{w_2+w_1}{2}$	Item ⑤ x Item ⑥	a_3	F_{2-1} x a_3		S_2 x (d_2-d_1)	
1	d_1		w_1					$F_{4-3} + F_{3-2} + F_{2-1}$		Σ
0	0		w_0							

*NOTES

(1) The center of gravity of a trapezoidal loading may be determined by the formula $\frac{x}{e} = \frac{2+R}{3(1+R)}$

where $R = \frac{h_2}{h_1}$; then $a_1 = \frac{x}{e}(d_4-d_3)$

(2) F_{4-3} , F_{3-2} is load between stations 4 and 3; 3 and 2, etc. (Item 6)

(3) S_3 , S_2 etc. is shear at stations 3, 2, etc. (Item 9)

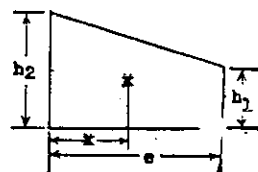

Figure 3-6. Determination of shears and bending moments.

The primary bending moments at various stations on a cantilever spar may be determined conveniently by the equation:

$$M_x = M_1 \pm S_1 x \pm \sum Fa \quad (3:8)$$

where M_1 and S_1 are the moment and shear at station 1; x , the distance between station 1 and x ; and $\sum Fa$, the sum of the moments about station x of all the loads acting between the stations. It will be found desirable to prepare a table similar to the one shown in figure 3-6 to facilitate the computations. If the distances between the various stations are relatively small, the center of gravities, a of the trapezoidal loadings may be assumed to lie midway between the stations with negligible error and slightly conservative results.

If concentrated loads exist at points on the span, the table may be modified easily to account for these loads.

The case of an externally braced spar may be handled in a manner similar to that for the cantilever spar, insofar as the determination of the shears and moments outboard of the strut and the moment at the root due to external loads are concerned. The root moment required in section 3.121 to determine the lift-strut reactions may be obtained conveniently by the foregoing procedure.

The general form of the moment and shear curves is shown in figure 3-7, (a) and (b), for braced and cantilever spars. It always is desirable to plot the bending moment and shear curves as a general check of the computations and

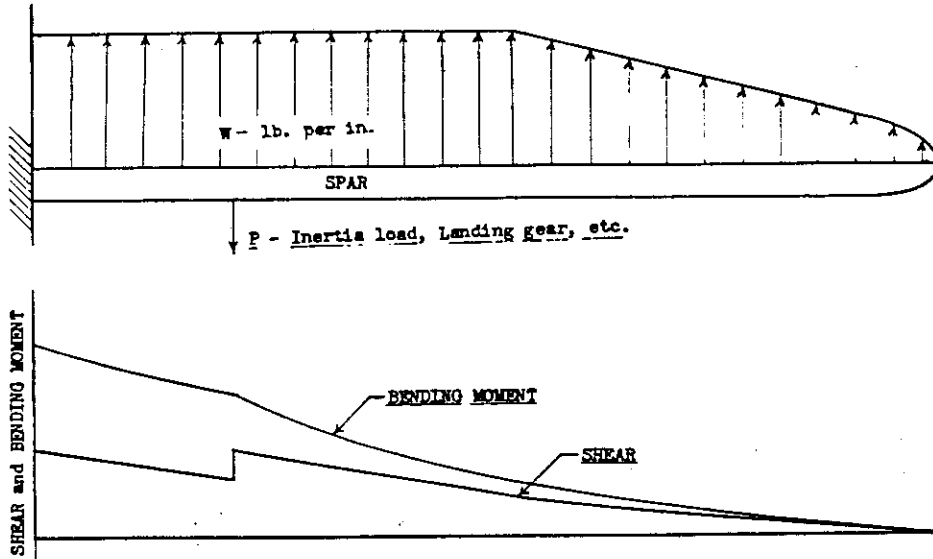

(a) BENDING MOMENT and SHEAR DIAGRAM - CANTILEVER SPAR

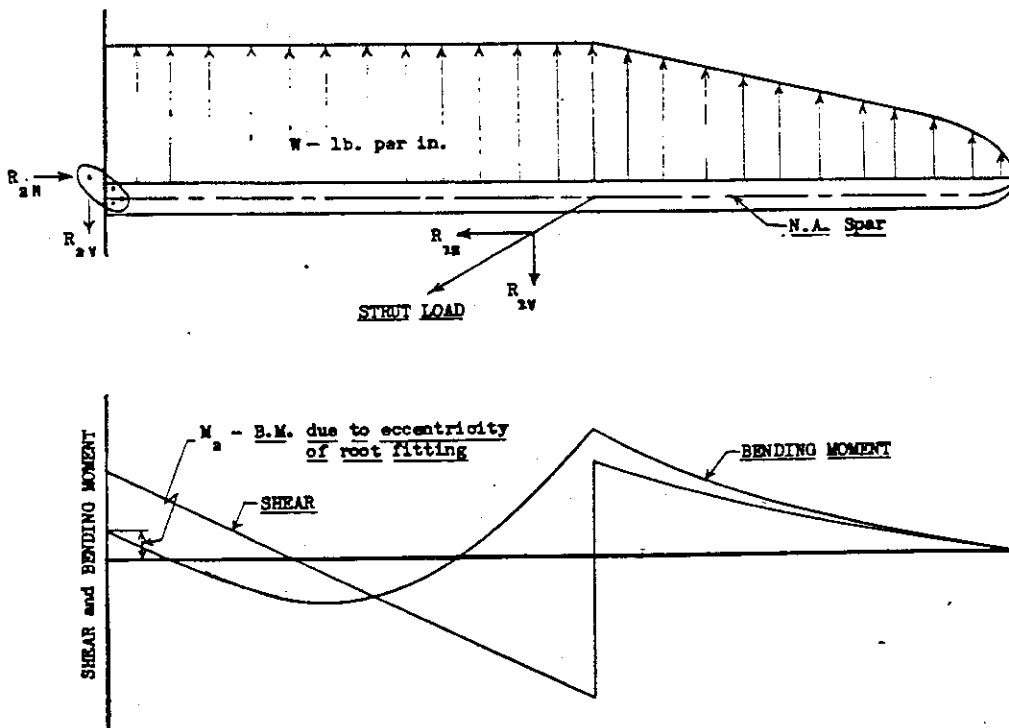

(b) BENDING MOMENT AND SHEAR DIAGRAM - BRACED SPAR

Figure 3-7. (a) Bending moment and shear diagram—cantilever spar. (b) Bending moment and shear diagram—braced spar.

to facilitate the investigation of stations along the span not covered in figure 3-6.

3.1140. *Beam-column effects (secondary bending)*. In connection with the bending moment and shear curves for a braced spar inboard of the strut point, where the spar is loaded as a beam and a column simultaneously, the effects of secondary

bending should be taken into account by use of the "precise" equations or the "polar diagram" method. The solution of the beam-column problem is covered extensively in several textbooks relative to airplane structures, and, therefore, will not be covered here (refs. 3-1, 3-15). It is necessary, however, to base such computations

on ultimate loads rather than on limit loads, in order to maintain the required factor of safety. Continuous spars having three or more supports should be investigated by means of the three-moment equation or other methods leading to equivalent results.

3.1141. *Effects of varying axial load and moment of inertia.* The drag-truss bays of a braced wing usually are shorter than the lift-truss bay, as indicated in figure 3-4. The axial loads in the spars due to the chord loading, therefore, vary along the span. Although the "precise" equations for a beam-column assume a constant value of axial load in the beam, it is generally satisfactory to determine a weighted value of axial load for use in determining the "precise" bending moment. Referring to figure 3-8:

$$P_c = \frac{P_1 L_1 + P_2 L_2 + P_3 L_3}{L_1 + L_2 + L_3} \quad (3:9)$$

where P_c is the weighted axial load due to chord loading, and P_1 , P_2 , and P_3 are the spar axial loads in the drag bays 1, 2, and 3. The total axial load in the spar is:

$$P_t = P_s + P_c \quad (3:10)$$

where P_s is the spar axial-load component from the lift strut or wire.

Generally, the moment of inertia, I , also varies along the span and a weighted value of I may be determined for use in the "precise" equations, as follows:

$$I_w = \frac{I_1 L_1 + I_2 L_2 + I_3 L_3}{L_1 + L_2 + L_3} \quad (3:11)$$

where I_1 , I_2 , and I_3 are the moments of inertia in bays 1, 2, and 3. If the "polar diagram" method is used, the actual variation can be taken into account.

3.115. *Internal and allowable stresses for spars.*

3.1150. *General.* The allowable stresses for spars may be found in section 2.3. In beams subjected to combined bending and compression, the margin of safety computed by a simple comparison of the internal and allowable stresses may be meaningless, particularly when the beam-column is approaching the critical buckling point. True margins of safety may, therefore, be determined only by successive approximations. For example, if a spar is rechecked after increasing all external loads and moments by 10 percent, and still found satisfactory, the true margin of safety is at least 10 percent.

3.1151. *Wood spars.* In general, a spar will be subject to bending, axial (tension or compression), and shear stresses. The total stress due to bending and axial load may be computed by the usual expression:

$$f_t = \frac{Mc}{I} + \frac{P}{A} \quad (3:12)$$

where M includes secondary bending. In computing the section properties of a wood spar, the following points are worthy of attention. Consider the spar section shown in figure 3-9.

- (a) Where the two vertical faces of the spar are of different depths, the average depth of the section may be used, as shown by h .
- (b) If the webs are plywood, only those plies parallel to the spar axis and one-quarter of those plies at 45° may be used in the computation of A and I of the sections. These are approximate rules to allow for the difference in modulus of elasticity of the plywood and the solid wood. If the plywood webs are neglected entirely, the computation of the section properties is simplified and the results are more conservative.

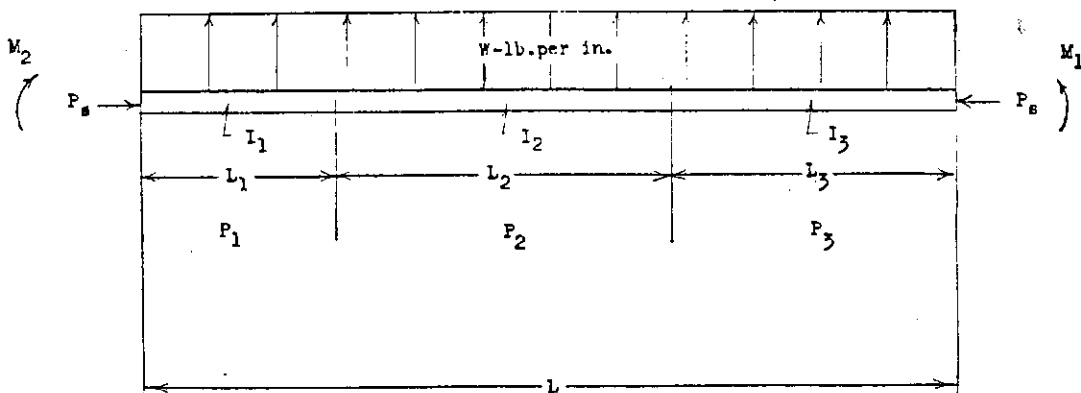

Figure 3-8. Distribution of forces on wood spar section.

$$f_s = \frac{SQ}{b'I} \quad (3:13)$$

- (c) When investigating a section, such as A-A in figure 3-9, the full section should be considered effective only if the glue area is sufficient to develop the full strength of the side plates. In general, the distance a should not be less than 10 times or 15 times the thickness of a side plate for softwoods and hardwoods, respectively. The reinforcing blocks should be beveled, as shown, to prevent stress concentration which may lead to consequent failure in the glued joint at the edge of the reinforcement.
- (d) Filler blocks may likewise be used in computing the section properties, provided the length of the blocks and their glue area to webs and flanges is sufficient to develop the required bending stresses.
- (e) In the detailed investigation of a spar section, the reduction in strength due to bolt holes should be considered when computing the section properties. In computing the area, moment of inertia, etc., of wood spars pierced by bolts, the diameter of the bolt hole should be assumed greater than the actual diameter by the amount specified by the procuring or certificating agency. In computing the properties of section A-A (fig. 3-9), it should be assumed that all the bolt holes pass through the section, because failure might actually occur along the line $u-v$.

The longitudinal shear stress in the web of a spar may be obtained from the expression:

In the determination of Q , for spars with plywood webs, the recommendations in (b) should be followed. However, the value of b' in the expression should be the total web thickness. For tapered spars, the shear stress may be reduced to allow for the effects of taper in accordance with section 3.1352.

3.116. *Special problems in the analysis of two-spar wings.*

3.1160. *Lateral buckling of spars.* For conventional two-spar wings, the strength of the spars against lateral buckling may be determined by considering the sum of the axial loads in both spars to be resisted by the spars acting together. The total allowable column strength of both spars is the sum of the column strengths of each spar acting as a column the length of a drag bay. Fabric wing covering may be assumed to increase the fixity coefficient to 1.5. When further stiffened by plywood or metal leading-edge covering extending over both surfaces forward of the front spar, the fixity coefficient may be assumed to be 3.0.

3.1161. *Ribs.* Analytical investigation of a rib generally is not acceptable as proof of the structure. In some cases, however, a rib may be substantiated by analysis when another rib of similar design has been analyzed, and subsequently strength-tested. In general, it may be desirable to analyze a rib in order to determine the approximate sizes of the members.

3.1162. *Fabric attachment.* Although the fabric-

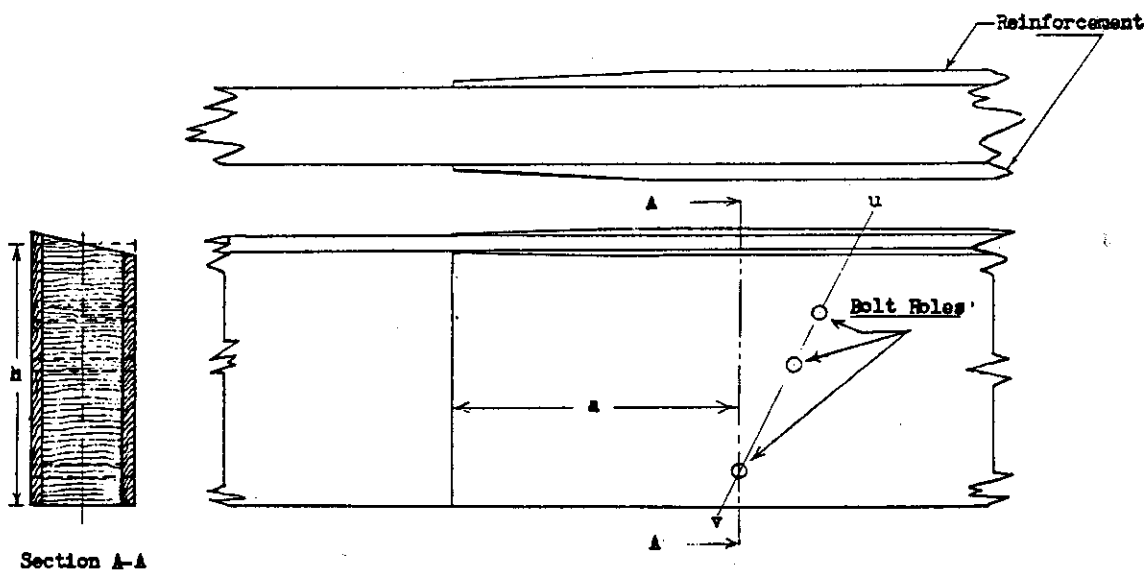

Figure 3-9. Wood spar section.

attaching method usually is not stress analyzed, it is, of course, important that the rib-lacing strength and spacing be such that the load will be adequately transmitted to the ribs. The specifications of the procurement or certifying agency in regard to lacing-cord strength and spacing should be followed. Unconventional fabric-attachment methods should be substantiated by static tests or equivalent means to the satisfaction of the agency involved.

3.12. TWO-SPAR PLYWOOD COVERED WINGS.

3.120. *Single covering.* Two-spar wings covered with plywood on only one surface (upper or lower) should be considered as independent spar wings, in accordance with section 3.11, and the plywood covering designed to carry the chordwise sheer loads with the ribs functioning as stiffeners and load distribution members. The center of shear resistance of the plywood covering may be eccentric to the applied drag load (fig. 3-15 b). The resulting torque will then be resisted by a couple consisting of up-and-down force on the two spars.

3.121. *Box type.* Two-spar wings with both upper and lower surfaces covered with plywood, forming a closed box, should be treated as shell wings in accordance with section 3.13.

3.13. REINFORCED SHELL WINGS.

3.130. *General.* The types of wing structure considered under this heading are those in which the outside covering or skin, together with any supporting stiffeners, resists a substantial portion of the wing torsion and some of the bending. Various types of shell wings may be classified according to: the number of vertical shear webs, or number of "cells" into which these webs divide the wing section; whether the spanwise material is concentrated mainly at the shear webs or distributed around the periphery of the section as longitudinal stiffeners; whether the skin is "thin" so that it buckles appreciably at ultimate load, or "thick" so that it does not buckle appreciably. Typical shell wing sections are shown in figure 3-10.

In shell wings the distributed airloads normal to the surface are carried to the ribs by the skin and its stiffeners. The ribs maintain the shape of the section and transmit the airloads from the skin to the vertical shear webs or to other portions of the skin such as the leading edge, which are capable of carrying vertical shear. Main or "bulkhead" ribs perform similar functions for concentrated loads, such as those due to nacelle landing gear, and fuselage reactions. The vertical

shear from the ribs is carried to the wing reaction points by the shear webs and portions of the skin. The shear in these elements creates axial bending stresses in the beam flange material. When comparatively stiff spanwise stiffeners are used, they also act as effective flange material, receiving their axial loads from the webs through shear in the skin. The contribution of the skin to the bending strength of the wing depends on its degree of buckling and relative modulus of elasticity.

From this general picture, it is evident that broad simplifying assumptions are necessary to make a stress analysis of a shell wing practicable, and that the computed stresses in the various elements are likely to be less exact than in the case of statically determinate independent spar wings. In metal shell structures, elements which become too highly stressed generally yield without difficulty and the load is redistributed to less highly stressed elements. In wood structures, however, some types of elements are unable to accommodate themselves to secondary stresses which would be of no importance in metal structures, for example, buckles of sharp curvature relative to the thickness are apt to split plywood. The stress analysis methods presented in this section should therefore be considered only as reasonable approximations until the designer has had experience in applying a particular method to a particular type of structure and has correlated the analysis procedures with the results of static tests.

3.131. *Computation of loading curves.*

3.1310. *Loading axis.* In determining the shear and bending stresses in shell wings, it has been found convenient to transfer the distributed air and inertia loads to a suitable spanwise loading axis by computing net beam, chord, and torque loadings at points or stations along such axis. The position of the loading axis may be chosen arbitrarily if the corresponding moment and torque components acting at a particular section of the wing are then properly applied to the various elements of the section in a manner consistent with their structural behavior. Since a reinforced shell wing is usually a complex nonisotropic structure in which some of the elements resist axial loads in a particular direction only, the true stress conditions resulting from the interaction of elements having various directions at a given section are often difficult to analyze. It is therefore recommended that the loading axis be located inside the wing, approximately parallel to the

SINGLE CELL SECTIONS

"D" - Nose Type

Box Beams

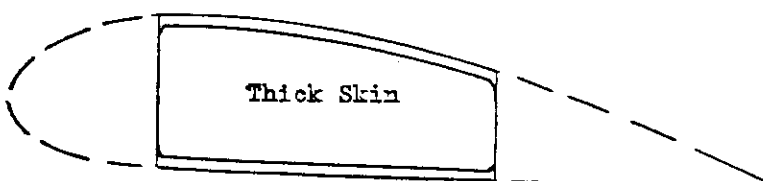
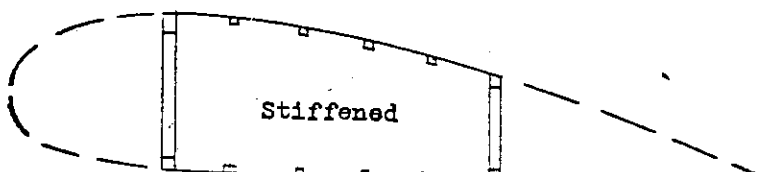
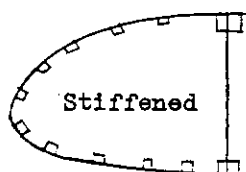
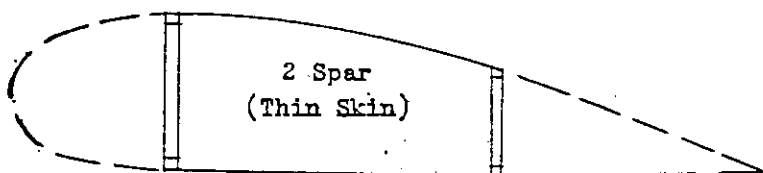
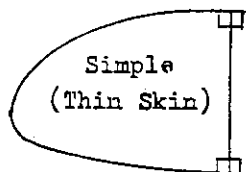

TWO CELL SECTIONS

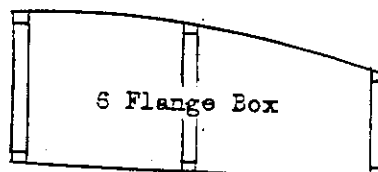
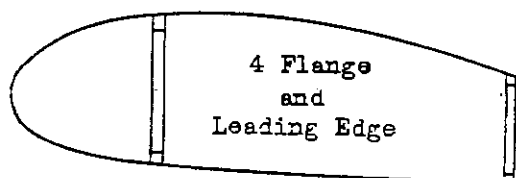

MULTI-CELL SECTION

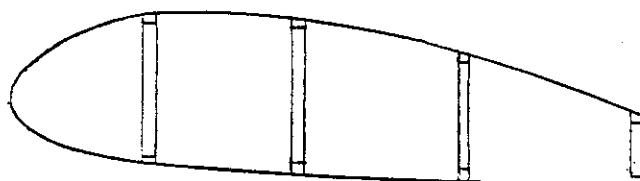

Note: Other types of Two Cell Wing Sections may have stiffeners or thick skin similar to the single cells shown above.

Figure 3-10. Typical shell wing sections.

principal bending and shear elements. Such a location should tend to reduce errors in the process of transferring external loads and torques to the loading axis and redistributing them to the structural elements. Section 3.135 shows that the use of a loading axis in the main shear web is often convenient for the shear distribution analysis, without further transfer of loads and torques.

If the loading axis is located as suggested, it is necessary for it to change direction where the principal structural elements change direction; for example, where an outer wing panel having dihedral or sweepback joins a straight center section. The loadings due to the air and inertia loads are computed for each segment of the axis in the usual manner, but at the point of direction change, the

total moments and torque from the outboard segment should be resolved into the proper components relative to the inboard segment.

The formulas given in section 3.1311 for computing the running loads and torque at various stations on the loading axis use airfoil moment coefficients (or center of pressure locations) based on airfoil sections parallel to the airflow. For a loading axis which is not perpendicular to such sections, these equations will therefore give small errors in the bending moment and torque values. These errors may be neglected unless the angle of inclination of the loading axis is large.

3.1311. *Loading formulas.* The net running load at points along the loading axis and the net running torsion about these points may be found from the following equations:

$$y_b = (C_N q + n_2 e) \frac{C'}{144} \quad (3:14)$$

$$y_c = [C_c q + n_{2x} e] \frac{C'}{144} \quad (3:15)$$

$$m_t = [\{C_N(x-a) + C_{M_a}\} q + n_2 e(x-j)] \frac{(C')^2}{144} \quad (3:16)$$

where:

y_b = running beam load in pounds per inch of span.

y_c = running chord loads in pounds per inch of span.

m_t = running torsion load in inch-pounds per inch of span.

a , j , and x are expressed as fractions of the chord at the station in question and locate points on figure 3-11 as follows:

a locates the point in the airfoil on which the moment coefficient, C_{M_a} , is based.

j locates the resultant wing dead weight at the station.

x is the distance from the leading edge to the loading axis, at the station.

q = dynamic pressure for the condition being investigated.

C_N and C_{M_a} are the airfoil normal and moment coefficients at the section in question.

C_c = airfoil chord coefficient at each station. The proper sign should be retained throughout the computations.

C' = the wing chord, in inches.

e = the average unit weight of the wing, in pounds per square foot, over the chord at the station in question. It should be computed or estimated for each area included between the wing stations investigated, unless the unit wing weight is substantially constant, in which case a constant value may be assumed. By properly correlating the values of e and j , the effects of local weights, such as fuel tanks and nacelles, can be accounted for directly.

n_2 = the net limit load factor representing the inertia effect of the whole airplane acting at the center of gravity. The inertia load always acts in a direction opposite to the net air load. For positively accelerated conditions n_2 will always be negative, and vice versa. Its value and sign are obtained in the airplane balancing process.

n_{2x} = net limit chord-load factor approximately representing the inertia effect of the whole airplane in the chord direction. The value and sign are

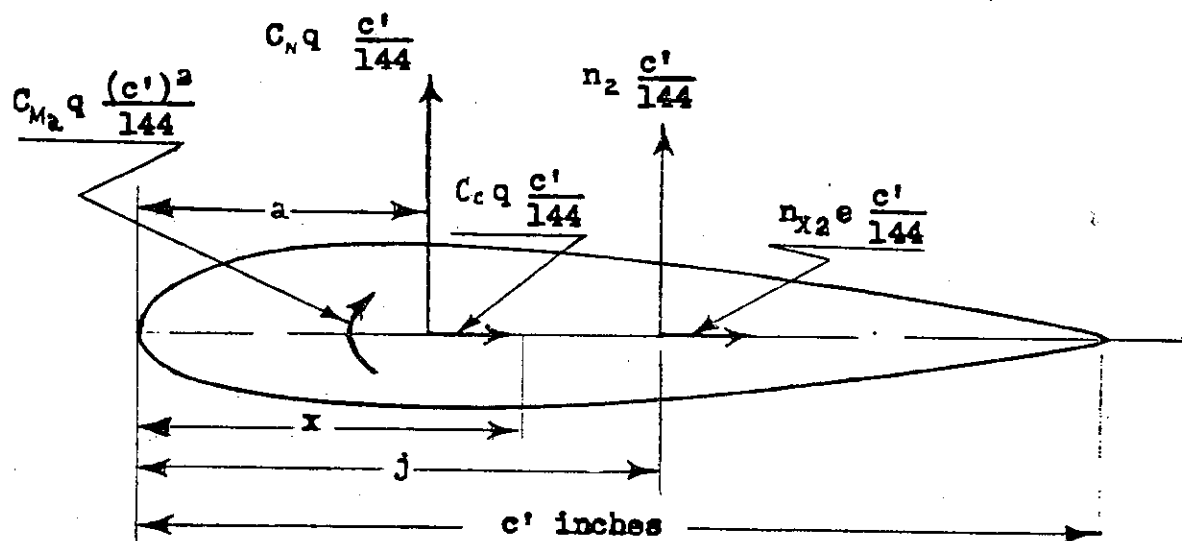

All Vectors Are Shown in Positive Sense

Figure 3-11. Section showing location of load axis.

Table 3-3. Computation of net loadings (constants)

	Stations Along Span				
1	Distance from root, inches				
2	$C'/144 = (\text{chord in inches}) / 144$				
3	x , fraction of chord				
4	a , fraction of chord (a.o.)				
5	j , fraction of chord*				
6	$e = \text{unit wing wt., lbs/sq.ft.*}$				
7	$x - a = \textcircled{3} - \textcircled{4}$				
8	$x - j = \textcircled{3} - \textcircled{5}$				
9	$\frac{(C')^2}{144}$				

* These values will depend on the amount of disposable load carried in the wing.

obtained in the airplane balancing process. Note that, when C_c is negative, n_z^2 will be positive.

Positive directions for all quantities are shown in figure 3-11. The computations required for this form of analysis can be carried out conveniently through the use of tables similar to tables 3-3 and 3-4.

The values of y_b , y_c , and m_t should be plotted against the span and, in case irregularities are found, they should be checked before proceeding with the calculations.

It is sometimes desirable to compute the airloadings and inertia loadings separately. The inertia loading, shear, moment and torsion curves then need be computed for only one condition (say, $n_z = 1.0$), the values for any other condition being obtained by multiplying by the proper load factor. The foregoing formulas may be modified for this purpose by omitting terms containing n_z for the airloading, and omitting terms containing q for the inertia loading.

3.132. *Computation of shear, bending moment and torsion.* The summation of the areas under the loading curves determined by the method described in section 3.131, from the tip to any wing station will give the values of the total load (shear) and of the total torque (torsion) acting at the station.

It is advisable to plot curves of the shear and torsion values against the span to determine if any irregularities have occurred in the computations. If concentrated weight and load items were not accounted for in the loading computations,

they should be taken care of by additional computations, and their effects shown on the shear and torsion curves.

The bending moments at any station of the wing can be found either by computing the moments, about the station, of the areas under the loading curves outboard of the station, taking into consideration moments due to concentrated loads, if such are present; or by summing up the areas under the shear curves from the tip to the station. A convenient tabular method of computing these values is also shown in figure 3-6; and typical curves are shown in figure 3-7.

The following quantities are now assumed to have been determined and plotted for any station on the loading axis:

S_{bL} , the total beam load (shear) through the loading axis in pounds.

S_{cL} , the total chord load (shear) through the loading axis in pounds.

M_{tL} , the torsion about the loading axis in inch-pounds.

M_{bL} , the beam moment in inch-pounds.

M_{cL} , the chord moment in inch-pounds.

Formulas of section 3.1311 give moments and torques whose magnitudes and directions are not necessarily consistent with the direction of the loading axis, but the errors may usually be neglected (sec. 3.1310).

3.133. *Computation of bending stresses.* The methods outlined herein are based on the application of the conventional bending theory to the wing section as a whole, rather than to individual

Table 3-4. Computation of net loadings (variables)

CONDITION _____

q	$C_{N_I}(\text{etc})$	C'_C	C'_M	n_2	n_{x_2}

		Distance b from root				
Normal Load	(Refer also to Table 3-2)					
	10	C_N (variation with span)				
	11	$C_{Nq} = 10 \times q$				
	12	$n_2 e = 6 \times n_2$				
	13	11 + 12				
14	$y_b = 13 \times 2$ lbs./in.					
Chord Load	15	C'_C (variation with span)				
	16	$C'_{Cq} = 15 \times q$				
	17	$n_{x_2} e = 6 \times n_{x_2}$				
	18	16 + 17				
	19	$y_c = 18 \times 2$ lbs./in.				
Unit Torque	20	C_{M_a} (variation with span)				
	21	7 x 10				
	22	20 + 21				
	23	22 x q				
	24	12 x 6				
	25	23 + 24				
	26	$m_t = 25 \times 9$				

spars deflecting independently. It is assumed that the axial deformation due to bending, for any element of the wing section, is proportional to the distance of the element from the neutral axis of the section. This means that in multispar shell wings the deflection of all spars is assumed to be substantially the same. These assumptions are valid only where the wing contains relatively rigid torsion cells so that wing twist is resisted by shear in the walls of these cells rather than differential bending of the beams. Experience indicates that this simple bending theory is satisfactory for the practical design of shell wings if allowances or corrections are made for the following conditions:

- (1) Excessive shear lag, or shear deflection, in the shell between various bending elements. Such deflections cause the actual stresses in elements remote from the vertical shear webs to be less than, and the stresses in elements adjacent to the shear webs greater than, the values indicated by the simple bending theory. In some types of structures as described

in section 3.1330 (5), these deflections may be considered negligible in the design of the wing as a whole. Since the bending elements receive and give up their axial loads through shear in the webs or skin to which they are attached, local shear stresses and deflections will be intensified in the region of discontinuities in the bending or shear elements. Shear lag is therefore likely to be appreciable in such regions. A convenient method of allowing for shear lag is to assume a reduced effective area for the bending elements affected, in computing the section properties as described in section 3.1330. The stresses computed for such elements by the bending theory will then be too high, and, to be consistent, should be reduced in the same ratio as the areas used in the section properties.

- (2) The effects of torsion on the bending stresses at the corners of a box beam.

This condition is usually dealt with after the bending stresses and shear distribution have been determined on the basis of the simple theory. See section 3.1370 for discussion.

3.1330. *Section properties.* A sufficient number of stations along the wing should be investigated to determine the minimum margins of safety. The information necessary to compute the section properties at each station selected for investigation may be conveniently obtained from a scale diagram of the wing section. Such a diagram (fig. 3-12) and accompanying data should show the following:

- (1) All material assumed acting in shear or bending (sec. 3.138) divided into suitable elementary strips and areas, with each such element designated by a suitable item number for use in tabular computations.
- (2) Thicknesses of skin and web elements, area and center of gravity of stiffeners and flanges, and the relative moduli of elasticity of all elements, normal to the section (secs. 2.1210, 2.52, and 3.138, or table 2-13). For example, the modulus of the beam flanges might be taken as a basic in tension and the moduli of other elements expressed as ratios thereto.
- (3) Reference axes from which the various elements are located. The amount of calculation will generally be less if the reference axes are made parallel to the beam and chord directions used in the loading curve determinations.

(4) Effective widths of skin assumed acting in compression in conjunction with stiffeners or flanges. These should be consistent with the methods used in determining allowable stresses, in accordance with section 3.138.

(5) Effectiveness factors for bending elements which have elastic modulus different from the basic value selected for the wing, or which are effected by shear lag. The final factor, e , includes both effects, and may be expressed as: $e = e_1 \times e_2$,

where e_1 is equal to $\frac{E_{element}}{E_{basic}}$, and e_2 is the shear lag factor.

A value of $e_2 = 1.0$ indicates that the effectiveness of an element is not considered reduced by shear lag, while $e_2 = 0$ indicates that it is completely ineffective. Shear lag may be general or local or a combination of both. General shear lag is greatest in a shell wing which has a major portion of the bending elements remote from the shear webs, relatively thin skin, and little or no taper in plan and front views. The general shear-lag effectiveness factors for such wings should be based on rational analysis or test data for similar wings, unless the spar web flanges can withstand stresses considerably higher than those computed by the simple bending theory (refs. 3-4, 3-9, and 3-13). In a wing having characteristics opposite to those described, general shear

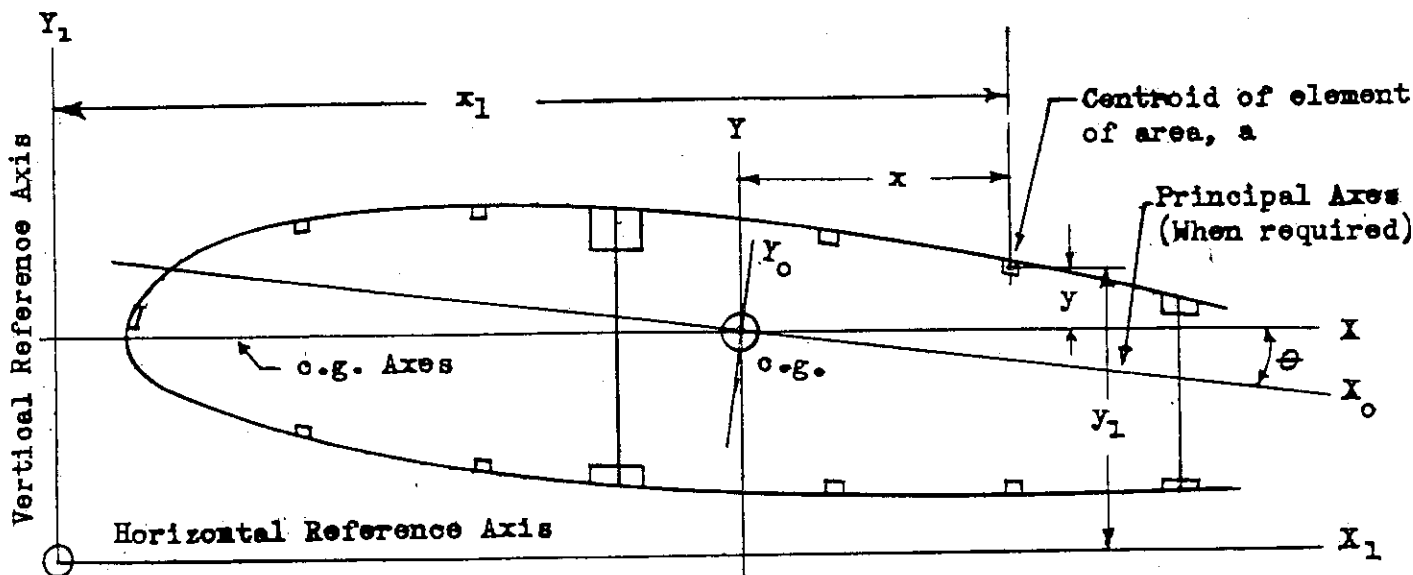

Figure 3-12. Diagram for computation of section properties.

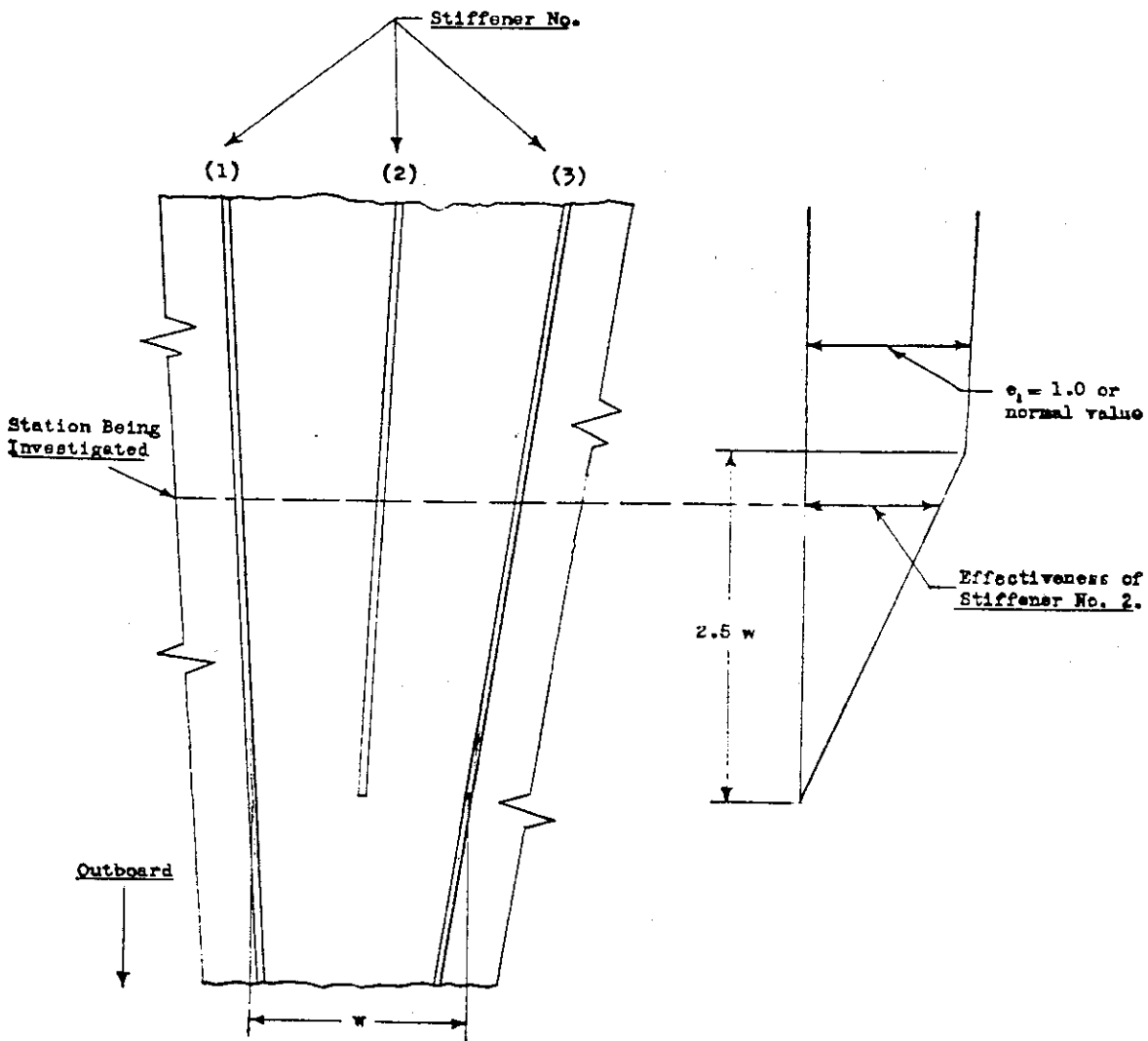

Figure 3-13. Effectiveness of discontinuous stiffener.

lag may be neglected if the spar flanges can withstand stresses slightly larger than those computed by the simple bending theory. Local shear lag due to discontinuities and cutouts may be estimated by determining e_2 from figures 3-13 and 3-14, or computed by methods of reference 3-13.

In using figure 3-14, L may be taken as $2.5W$ for conventional constructions employing stiff 45° plywood skin. A more rational value for L , applicable to all grain directions, may be computed from the following formula which takes into account the shear rigidity of the skin in relation to the axial load:

$$L = \frac{1.25 W'}{\sqrt{\frac{GtW}{E'A}}} \quad (3:17)$$

where

W' = width of cutout or free end.

G = effective shear modulus of skin.

t = thickness of skin.

E' = effective modulus of elasticity of composite section in tension or compression.

A = total effective area of skin and stiffeners in tension or compression.

With the foregoing information available, the wing-section properties may be computed in a tabular form, such as shown on table 3-5, the column headings meaning:

- (1) Effectiveness factor for item, e .
- (2) (a) Geometrical area of item, (A) .
(b) Effective area of item, (a) , $= eA$.
- (3) Beam distance of item from reference axis (y_1) .
- (5) Beam moment of area about the reference axis, (ay_1) .

The location of the X axis, passing through the center of gravity and parallel to the horizontal reference axis, should next be determined by dividing $\sum \text{col. (5)}$ by $\sum \text{col. (2b)}$.

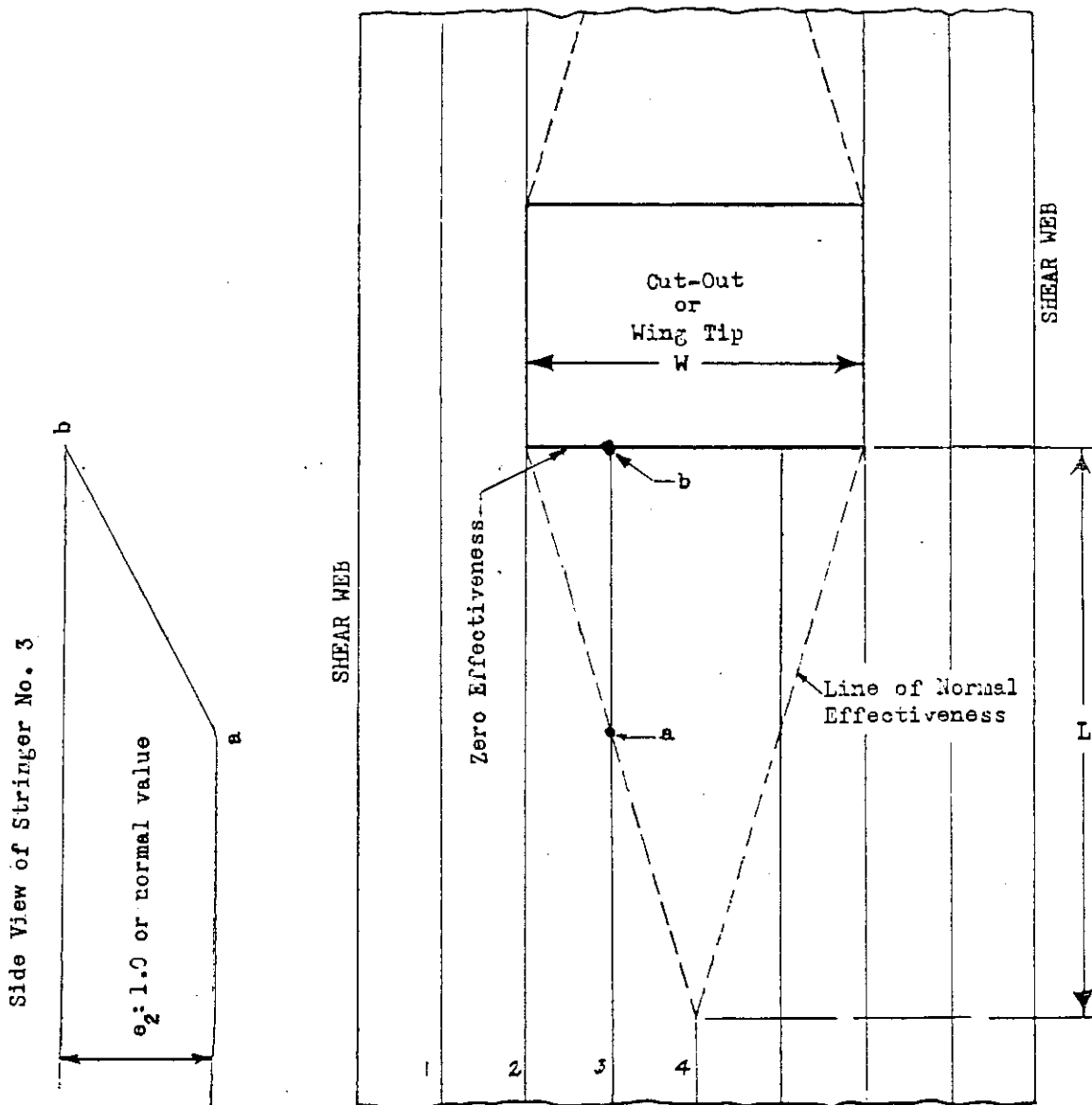

Figure 3-14. Effectiveness of stringers at cutout.

- (7) Beam distance of item from the X axis passing through the center of gravity (y).
- (9) Beam moment of the area about the X axis, (ay).
- (11) Second beam moment of area about the X axis, (ay^2).
- (13) Individual moments of inertia of items which are of sufficient magnitude to be included.

The sum of the items in column 9 for all of the wing elements above or all of the wing elements below the X axis is equal to the static moment of the section Q_x . The sum of items in columns 11 and 13 is equal to the moment of inertia of the wing section about the X axis. By a similar process, the wing-section properties about the Y axis can be determined by filling out the remaining columns in table 3-5 pertaining to chord distances

and moments. The X and Y axis are *not* necessarily the principal axes.

The sum of all of the items in column 15 is equal to the product of inertia of the section about the center of gravity axes. Careful attention should be paid to the use of the proper signs in computing the products of inertia and in the subsequent stress calculations.

When effective widths are used for skin in compression, it is evident that the section properties may change for inverted loads, and in such cases the necessary computations should be repeated accordingly.

3.1331. *Bending stress formulas.* The following formulas may be used for the computation of the bending stresses at any point on the wing section. These formulas are similar to those described in section 6:6 of reference 3-15, and permit the

stresses to be computed without determining the principal axes of inertia or the section properties relative thereto.

$$f' = -\frac{\bar{M}_b y}{I_x} - \frac{\bar{M}_c x}{I_y} \quad (3:18)$$

where

$$\bar{M}_b = \frac{M_b - M_c \frac{I_{xy}}{I_y}}{I - \frac{(I_{xy})^2}{I_x I_y}}, \text{ and } \bar{M}_c = \frac{M_c - M_b \frac{I_{xy}}{I_x}}{I - \frac{(I_{xy})^2}{I_x I_y}}$$

The values of M_b and M_c are the values of the bending moments about the X and Y axes, respectively, used in the section properties computations; the I values are determined by the methods outlined in table 3-5, and the x and y values are the distances to the points at which the bending stresses are desired.

If the analysis of some of the wing sections indicates that the value of I_{xy} is approaching zero, it is apparent that the reference axes chosen are nearly parallel to the section principal axes, and the analysis of similar wing sections may be simplified by omitting the computation of the product of inertia in table 3-5. The expression for the stress at any point in this case simplifies to:

$$f' = -\frac{M_b x}{I_x} - \frac{M_c y}{I_y} \quad (3:19)$$

When desired, the angle of inclination of the principal axes of inertia to the XY axes is given by the following relation (fig. 3-12):

$$\tan 2\theta = \frac{2I_{xy}}{I_x - I_y} \quad (3:20)$$

where the values on the right side of the equation are obtained from table 3-5.

The stress f' computed by the formulas applies directly only to elements having the elastic modulus selected as basic for the section, and a shear lag effectiveness factor of 1.0. The actual stress f for other elements is obtained by multiplying f' from the formulas by the proper effectiveness factor from table 3-5.

3.134. Secondary stresses in bending elements.

(a) *Air loads and bending deflections.* Stiffeners are normally subjected to combined compression and bending. The compression results from the stiffener acting as a part of the flange material of the entire section. Two of the conditions

producing bending in the stiffeners are: Part of the normal airload on the skin being carried to the ribs by the stiffeners, and curvature of the stiffeners due to bending deflection of the entire wing. Allowance for these bending loads may be made by using conservative values for the allowable compressive stress or, in relatively large rib spacings, by suitable computations and tests.

(b) *Diagonal tension field effects.* When the wing covering buckles in shear, additional stresses may be imposed on the spanwise stiffeners by the diagonal-tension field effects in the skin. If the initial buckling shear stress is greatly exceeded, it may be necessary to make additional analyses to account for the increased stiffener stresses. Shear buckles (diagonal tension fields) in curved skin tend to produce bending or sagging of the stiffeners between the ribs. Particular attention should be paid to the possibilities of the sagging type of failure in spanwise leading-edge stiffeners, especially when they are also subjected to combined beam and chord compressive loads. Combined loading tests or conservative allowable stresses based on simple tests in accordance with section 3.1381 should therefore be employed for D-nose spar and similar types of wings.

(c) Bending stresses due to torsion are discussed in section 3.1370.

3.135. Computation of shear flows and stresses.

3.1350. *General.* The methods outlined herein are based on the following principles: (refs. 3-5 and 3-11).

(1) The shear flows producing bending in the wing (direct shear) are distributed by the various shear elements to each ending element in such a manner as to produce the increase in axial load per unit of span required by the bending theory. In applying this principle, use is made of the computations performed in determining the bending stresses, and the results are affected by the same basic assumptions and limitations.

(2) The shear flows in the various shear elements of a torque box or cell are assumed to produce (or resist) torque about a reference point in accordance with the

elementary principles of shear flows, as illustrated in figure 3-15. This assumption is valid only where: The ribs and bulkheads are rigid in shear in their own plane, particularly at concentrated loads; the length of the torque box, or the distance from the section where a large concentrated torque, applied to the section where it is reacted, is relatively greater than the cross-sectional dimensions of the box; and where the cross sections of the wing are free to warp when the wing twists, as in a wing panel which is so joined to the center section that only the main beam can transmit bending, the remaining webs being pin-jointed. When any of these conditions are seriously violated, conservative overlapping assumptions should be made as to the shear in the various elements.

3.1351. *Shear flow absorbed by bending elements.* The rational methods for shear distribution first require the determination of the shear flows absorbed by the individual bending elements which may be determined by one of the following methods:

- (1) *Spanwise method.* The spanwise method requires the calculation of the total axial load in each bending element at various stations along the span. The change in axial load per inch of span at any point is then equal to the shear flow being absorbed by the element at that point.

This method takes account of beam taper, discontinuities and redistribution of bending material, and is therefore particularly applicable to complex structures where these conditions are involved to a considerable degree. The average axial stress, f' , (in terms of the "basic" elastic modulus) in each element having small depth compared to the whole section at a particular station may be obtained by substituting the x and y coordinates of the centroid of the element in the bending stress formula of section 3.1331. The total axial load, P , equals $f' \times a$, where a is the effective area of the element from the section properties computations. The shear flow, Δq , absorbed by the element is:

$$\Delta q = \frac{dP}{dZ} \quad (3:21)$$

where $\frac{dP}{dZ}$ is obtained by plotting P against the distance, Z , along the span, and finding the slope of the tangent at desired points. Δq may be most conveniently found by tabular methods, that is: $\Delta q = (P_2 - P_1) / \Delta z$, where P_1 and P_2 are the axial loads at two adjacent stations and Δz is the distance between them. Δq is considered positive when it tends to increase the tension on an element, proceeding from outboard to inboard, as shown in figure 3-16. A more complete description of this method is given in reference 3-18.

- (2) *Section method.* The section method determines the shear flow absorbed by the bending elements by considering one section at a time under the external shears at that section, with separate corrections, if desired, for the effects of wing taper. This method is obviously not correct for sections in the vicinity of cutouts on wings having distributed bending material. It is, therefore, more applicable to wings where the bending material is concentrated in beams which taper uniformly. The shear flow absorbed by any bending element is obtained from formulas similar to those for the bending stresses (equation 3:18), using the same section properties computations, as follows:

$$\Delta q = a \left[-\frac{V_y}{I_x} - \frac{D_z}{I_y} \right] \quad (3:22)$$

$$V = \frac{S_b' - S_c' \frac{I_{xy}}{I_y}}{1 - \frac{(I_{xy})^2}{I_x I_y}} \quad (3:23)$$

$$D = \frac{S_c - S_b' \frac{I_{xy}}{I_x}}{1 - \frac{(I_{xy})^2}{I_x I_y}} \quad (3:24)$$

where:

a = effective area of element.

x and y are coordinates of centroid of element from section diagram. Deep elements, such as solid spars, should be broken into smaller elements.

I_x , table 3-5.

I_y , table 3-5.

$I_{xy} = \sum axy$, col. 15, table 3-5.

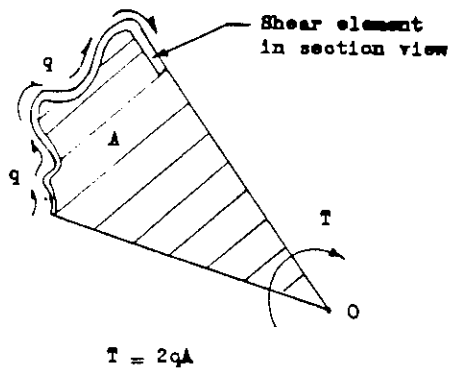

(a) TORQUE

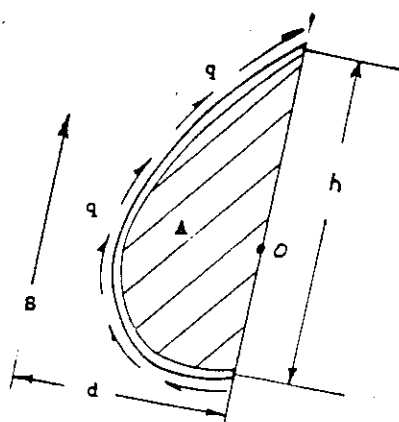

(b) RESULTANT SHEAR

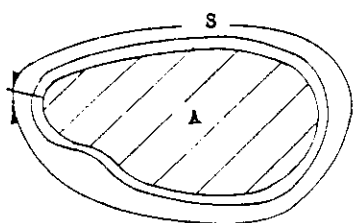

$$\theta = \frac{1}{2GA} q \frac{S}{t}$$

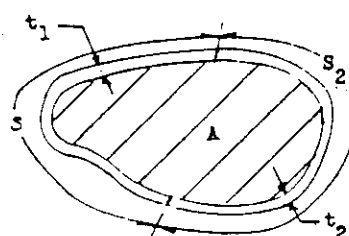

(e) TWIST OF SHEAR CELL

SYMBOLS

- q = shear applied per inch of shear element in section view. (Lb. per in.)
- S = resultant of total shear acting on shear element.
- s = length of median line of shear element in section view.
- t = thickness of shear element.
- f_s = shear stress (psi.) = $\frac{q}{t}$
- h = length of chord joining ends of shear element.
- o = reference point about which torque is taken.
- A = area enclosed between median line of shear element and radii drawn from extremities to O.
- θ = angle of twist of shear cell (radians) per inch of length normal to the section.
- G = modulus of rigidity of portion of cell wall.
- T = torque about reference point.

Figure 3-15. Properties of shear flows.

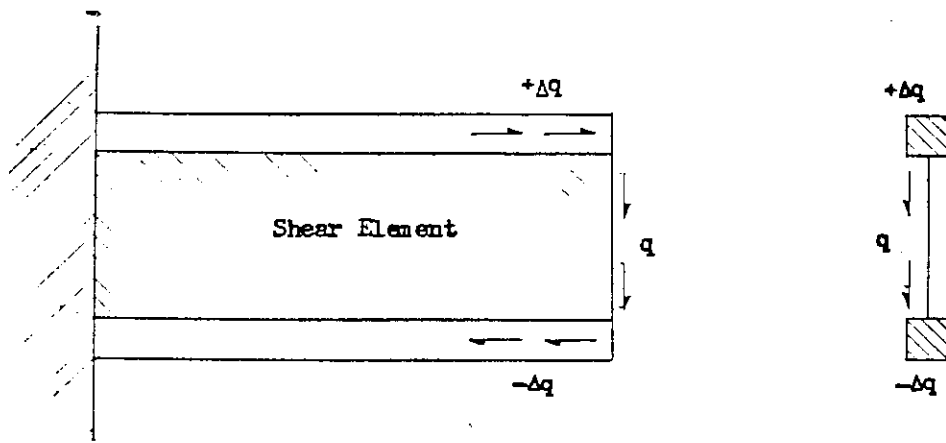

(a)

B. PARTIALLY BUCKLED

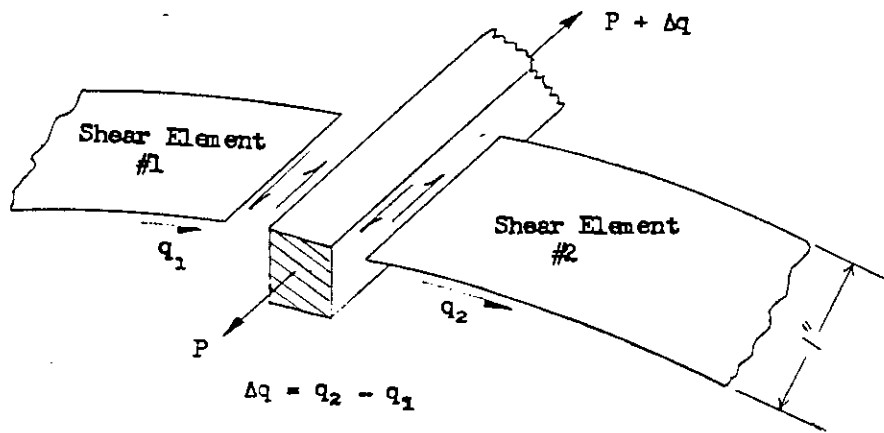

(b)

Figure 3-16. Sign conventions for shear flows.

S'_b = the total external beamwise shear (parallel to the Y reference axis for the section) resisted by the shear elements at the section, positive upward. It may include a shear correction due to taper in depth, as described in section 3.1352.

S'_c = the total external chordwise shear (parallel to the X axis) resisted by the shear elements at the section, positive rearward. It may include a shear correction due to taper in plan view.

3.1352. *Shear correction for beam taper.* When a beam having concentrated flanges is tapered in depth, a part of the external shear at any station is resisted by components of the axial loads in the flanges, as shown in figure 3-17. That part of the shear resisted by the flange axial loads is: $\Delta S = \frac{M}{L_o}$, where M is the moment at the station and L_o is the distance from the station to the point where

centerlines of the flanges would meet if prolonged. The shear resisted by the shear elements is then: $S'_b = S_b - \Delta S_b$. If the flange material is distributed over the wing surface a conservative average taper may be assumed. These corrections for taper should not be used with the spanwise method of determining shear flow absorbed by bending elements.

3.1353. *Simple D spar.* The type of structure considered under this heading is shown in figure 3-18. The method described herein is rational in regard to beamwise shear and torque if the following idealizing assumptions are applicable. The beamwise bending material is assumed concentrated in flanges at the vertical web; the leading edge is assumed to be thin, that is, not capable of carrying beamwise bending, and the leading edge strip (or equivalent material resisting chordwise

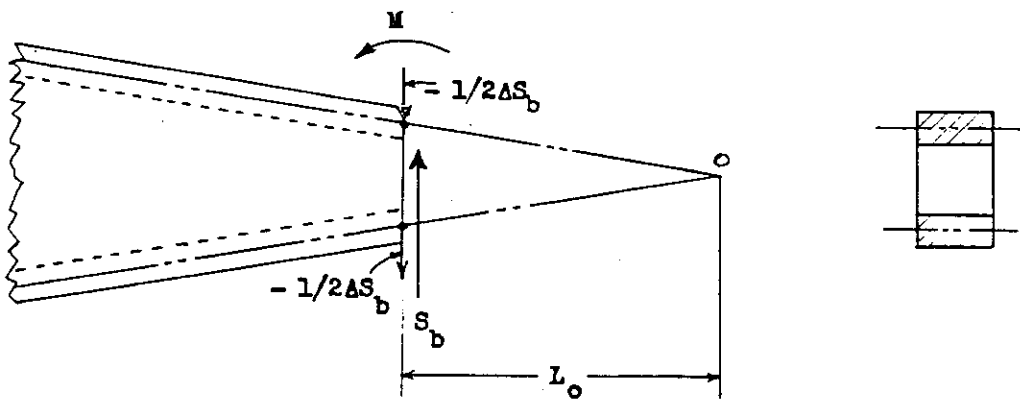

ΔS_b = portion of shear resisted by axial loads in flanges of tapered beam
 $= \frac{M}{L_o}$

Figure 3-17. Shear correction for tapered beam.

bending), is assumed to be located so as not to be affected by beamwise bending nor to incline the principal axes to the vertical web. As in any single cell, the shear flow is statically determinate, and, under the above assumptions, readily apparent. If the external loads are transferred to a point on the neutral axis in the vertical web, as shears parallel and perpendicular to the web, and a torque about the point, as shown in figure 3-18 the parallel shear, S'_b , is resisted entirely by the vertical web, so that $q_b = S'_b/h$, where h is the height between the centroids of the flanges. The torque, M_t , is resisted by the torsion cell, requiring a shear flow around the periphery: $q_t = \frac{M_t}{2A}$, where A is the enclosed area.

The shear S'_c is assumed resisted equally by the upper and lower skin, so that: $q_c = S'_c/2d$, where d is the distance from the vertical web to the leading edge strip.

Then: q_w (vertical web) = $q_b - q_t$; and $q_{L.E.} = q_t \pm q_c$, with the sign conventions shown on the diagram.

If the bending material of a D-spar is largely distributed around the periphery in the form of a thick skin or spanwise stiffeners, the general rational method for single cells, described in the following, is more applicable.

3.1354. Rational shear distribution.

3.13540. Single cell—general method. The following method is applicable to single cell structures having the bending material distributed in the form of a thick skin or any number of concentrated flanges or stiffeners. However, when such material is in the form of thick skin, it is assumed divided into strips each of which is considered a

concentrated element. Since the single cell is statically determinate, the elastic properties of the shear material are not necessarily involved in determining the stress distribution, although they are required in determining the twist or shear center. For simplicity, the shear center will not be used in computing shear flows and stresses. Its location may be readily determined after the shear flows are known. The method of computing shear flows is briefly outlined as follows: Referring to figure 3-19, the shear flow in the main vertical web is considered as an unknown, q_m , and the shear in each successive shear element around the periphery of the cell is expressed in terms of q_m by successively adding (algebraically) the shear flows, Δq_n , absorbed by the bending elements. The sum of the torques due to each shear element, about reference point O in the main vertical web, is then computed from the principles of shear flows (figure 3-15) and equated to the external

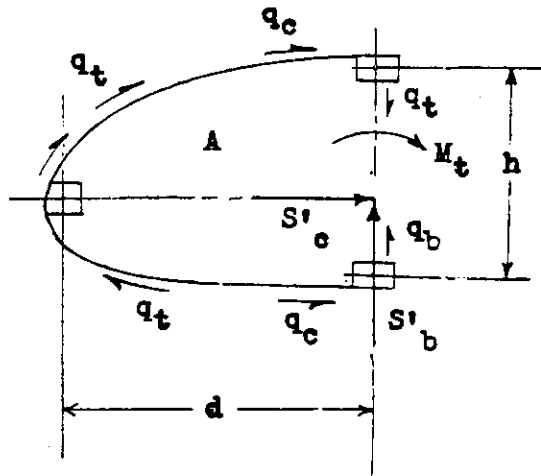

Figure 3-18. Shear in simple D-spar.

torque, M_t . This equation is solved for q_m , and the numerical values of the remaining shear flows obtained by successive addition of the Δq values, as explained. By using a suitable notation, the computations may be reduced to a simple tabular form as shown on table 3-6.

Such a notation is described as follows, and is illustrated in figure 3-19, where the assumed posi-

tive directions of quantities are as shown:

M_t = the resultant external moment applied at point O when the external shear S_b' and S_c' have been transferred to that point.

q_m = shear flow in main web.

q_1, q_2, q_3 , etc., are shear flows in successive shear elements numbered clockwise around the section, as shown.

Table 3-6. Shear-flow computations for single cell

(1)	(2)	(3)	(4)	(5)	(6)
n	Δq_n	$\sum_1^n \Delta q_n$ $= \sum_1^n (2)$	A_n	$A_n \sum_1^n \Delta q_n$ $= (4) \times (3)$	q_n $= q_m + (3)$
1	Δq_1		A_1		
2	Δq_2		A_2		
3	Δq_3		A_3		
$N-1$					
N					
	$\sum_1^N (2)$		$\sum_1^{N-1} (4)$	$\sum_1^{N-1} (5)$	

$$q_m = \frac{M_t}{2A} - \frac{1}{A} \sum_1^{N-1} \quad (5)$$

Notes:

$$\sum_1^N (2) \quad (2) \text{ should approximate } 0.$$

$$\sum_1^{N-1} (4) \quad (4) \text{ should approximate total area} = A.$$

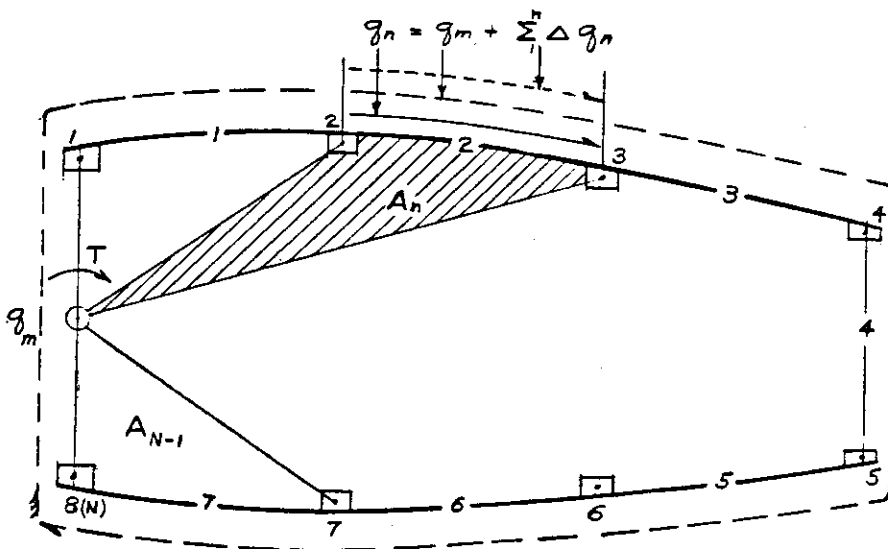
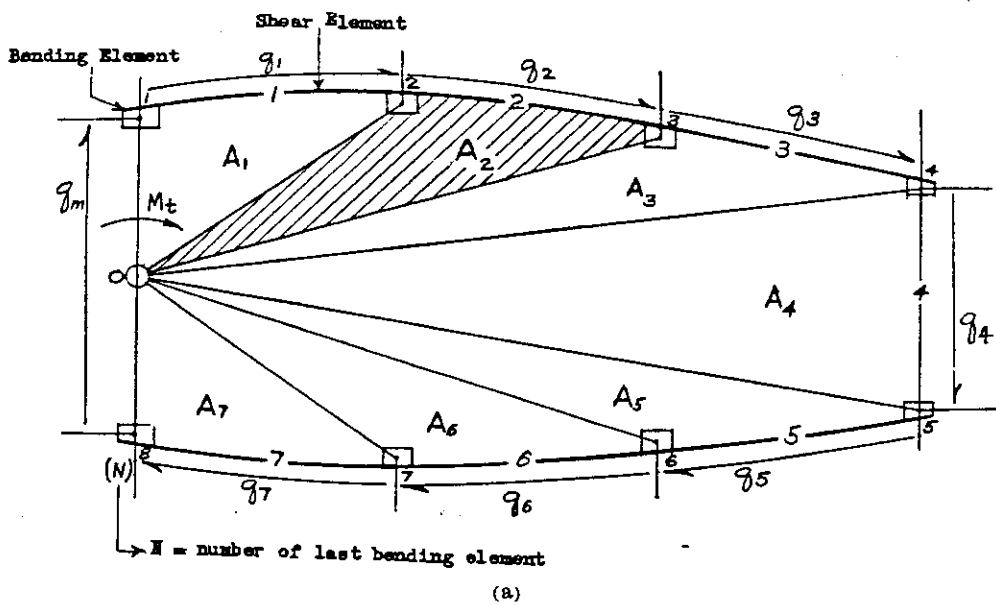

Figure 3-19. Rational shear flow—single cell.

q_n = shear flow in n th shear element.

$\Delta q_1, \Delta q_2, \Delta q_3$, etc., are shear flows absorbed by bending elements correspondingly numbered. Δq is positive when it tends to produce tension in the bending element, as shown in figure 3-16. It is produced by (or requires) a resultant shear flow directed away from the element in section view. The values of Δq are assumed to have been determined by methods such as those of section 3.1351.

Δq_n = shear flow absorbed by n th shear element.

A_1, A_2, A_3 , etc., are the areas enclosed between shear elements and radii from the reference point, O , to centroids of the bending elements.

A = enclosed area of entire section.

T = total torque of shear elements about point O .

\sum_1^n = summation of quantities for elements 1 through n , where $n=1, 2, 3$, etc.

N = number of last bending element (lower main flange).

$N-1$ =number of last shear element (not counting main web).

The expressions for shear flow in any element in terms of q_m , using sign conventions of figure 3-16, are:

$$\begin{aligned}\Delta q_1 &= q_1 - q_m \longrightarrow \Delta q_1 = q_m + \Delta q_1 \\ \Delta q_2 &= q_2 - q_1 \longrightarrow \Delta q_2 = q_m + \Delta q_1 + \Delta q_2 \\ q_n &= q_m + \sum_1^n \Delta q_n\end{aligned}\quad (3:25)$$

Equation (3:25) is represented graphically on diagram (b) figure 3-19 by a flow q_m around the entire section, to which is added flow $\sum_1^n \Delta q_n$ at any shear element to obtain the total flow q_n acting in that element.

The expression for the total torque of the shear elements about point O , figure 3-19(a), is:

$$T = \sum 2 A_n q_n$$

or

$$\frac{T}{2} = \sum A_n q_n, \text{ which, from diagram (b)}$$

of figure 3-19

$$\begin{aligned}&= A q_m + \sum_1^{N-1} \left(A_n \sum_1^n \Delta q_n \right) \\ &= \frac{M_t}{2} \text{ (equilibrium of internal and} \\ &\quad \text{external loads)} \\ A q_m &= \frac{M_t}{2} - \sum_1^{N-1} \left(A_n \sum_1^n \Delta q_n \right) \\ q_m &= \frac{M_t}{2A} - \frac{1}{A} \sum_1^{N-1} \left(A_n \sum_1^n \Delta q_n \right)\end{aligned}\quad (3:26)$$

Equations (3:25) and (3:26) may be represented in the tabular form shown by table 3-6. Equations (3:25) and (3:26) and table 3-6 are directly applicable to stiffened- D -nose type wings if the sign conventions and numbering shown in figure 3-20 are employed.

3.13541. *Two cell—general method.* The following method is an extension of the general method for single cells. The two-cell structure is statically indeterminate since the division of the total torque between the two cells depends upon their relative torsional stiffnesses. A shear flow in an element of the front cell and a flow in an element of the rear cell are therefore considered as unknowns, and the flows in the remaining elements expressed in terms of these two unknowns. One independent

equation is obtained from $\sum \text{torques} = 0$, and another from the fact that the twist of the front cell equals the twist of the rear cell. The two unknown shear flows are obtained by simultaneous solution of these equations, and the remaining flows computed by successively adding or subtracting the shear flows absorbed by the bending elements. The notation is illustrated in figure 3-21, where the following symbols are additional to those described in section 3.13540 for single cells.

q_m =shear flow in main web.

q_f =shear flow in first shear element (numbered 0) of front web.

$s_0, s_2, s_3, \dots, s_n$, are lengths of shear elements.

$c_0, c_1, c_2, \dots, c_n$, are elastic constants of the shear elements.

$c = \frac{s}{t_e}$, where t_e is the effective thickness of the shear element, that is: $t_e = t_1 \times \frac{G_1}{G}$, where t_1 is the geo-

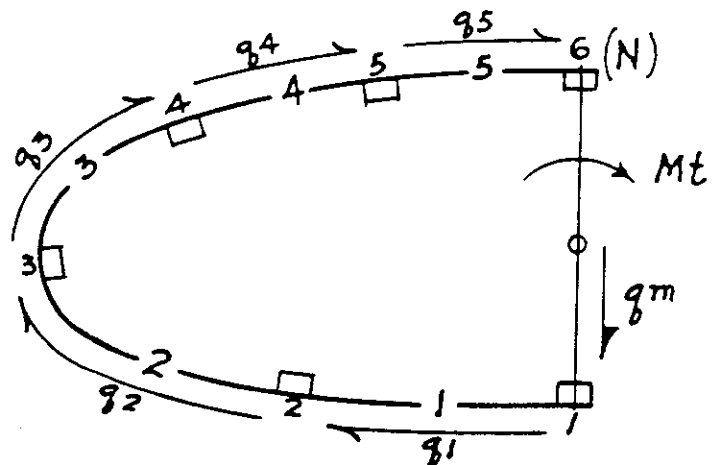

Figure 3-20. Conventions for stiffened- D nose section.

metrical thickness of the element, G_1 , the shear modulus of the element, and G the shear modulus of the material considered basic for the section (sec. 2.52). If a particular element is expected to buckle appreciably in shear, the value of G_1 should be reduced accordingly.

A_F =enclosed area of front cell.

A_R =enclosed area of rear cell.

$$A = A_F + A_R.$$

$$R = \frac{A_F}{A_R}$$

\sum_1^n =summation of quantities for elements 1 through n , where $n=1, 2, 3$, etc.

N =number of upper flange of main web.

M =number of lower flange of main web.

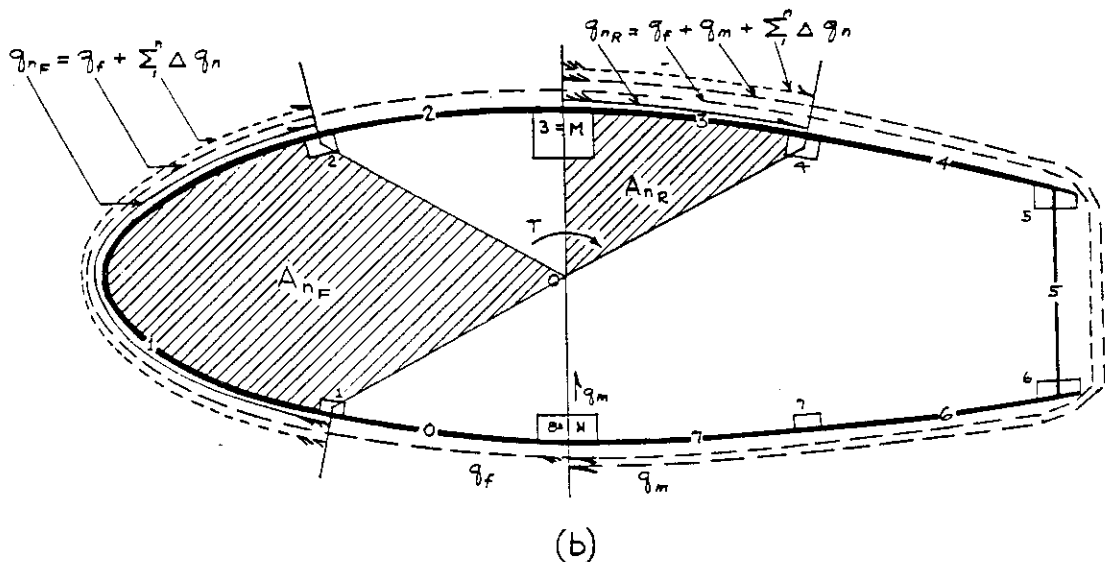
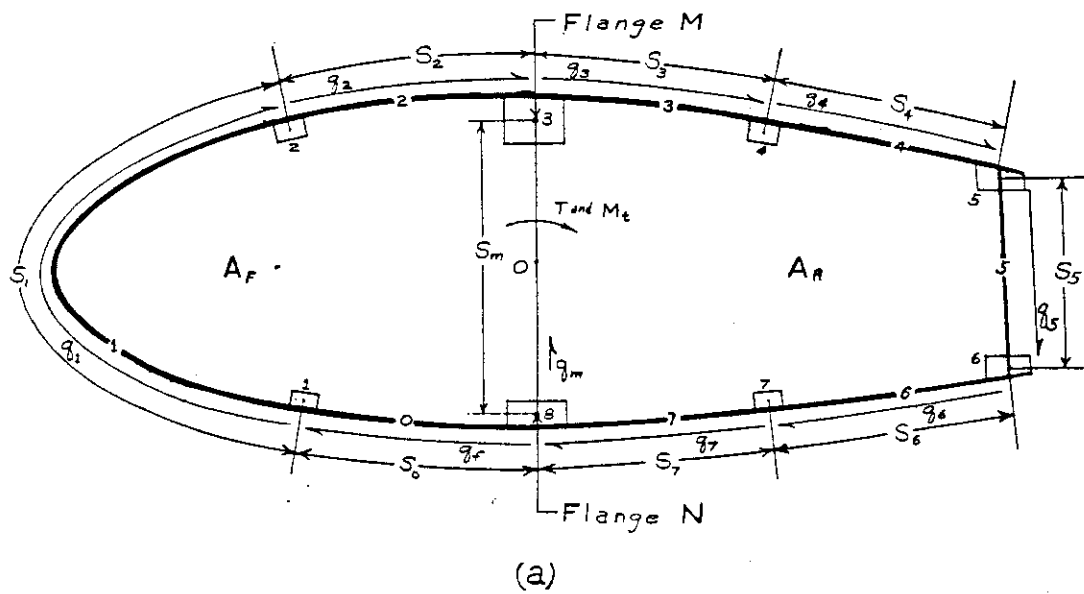

Figure 3-21. Rational shear flow; two-cell wing.

Subscripts F and R refer to front and rear cells, respectively.

Shear flow in any shear element (see derivation for single cell).

Front cell:

$$q_{nF} = q_f + \sum_1^n \Delta q_n \quad (3:27)$$

Rear cell:

$$q_{nR} = q_f + q_m + \sum_1^n \Delta q_n \quad (3:28)$$

Equation 3:27 and 3:28 are represented graphically on diagram (b) of figure 3-21.

Torque about point O .

$$\frac{T}{2} = \sum A_n q_n, \text{ which from diagram (b), figure 3-21,}$$

$$= q \cdot A + q_m A_R + \sum_1^{N-1} \left(A_n \sum_1^n \Delta q_n \right) = \frac{M_t}{2} \text{ (External torque)}$$

$$q_f A + q_m A_R = \frac{M_t}{2} - \sum_1^{N-1} \left(A_n \sum_1^n \Delta q_n \right)$$

$$q_f + \frac{A_R}{A} q_m = \frac{M_t}{2A} - \frac{1}{A} \sum_1^{N-1} \left(A_n \sum_1^n \Delta q_n \right) \quad (3:29)$$

which may be written in the form

$$X_2 q_f + Y_2 q_m = Z_2 \quad (3:30)$$

Where X_2 , Y_2 , and Z_2 are numerical constants, and q_f and q_m are unknown quantities.

Consistent deformations. The angle of twist θ is the same for front and rear cells.

Therefore,

$$\theta = \frac{1}{2A_{cell}} \sum q \frac{s}{Gt_s} \quad (3:31)$$

for each cell, where the summation is taken entirely around the cell (fig. 3-15).

$$2G\theta = \frac{1}{A_{cell}} \sum qc \quad (3:32)$$

G is taken out of the summation sign as a constant, since all elements are reduced to a common basic shear modulus by use of effective thicknesses. Therefore:

$$\frac{1}{A_F} \sum qc = \frac{1}{A_R} \sum qc$$

$\sum qc = R \sum qc$, which is from diagram (b) of figure 3-21:

$$q_f \sum_0^{M-1} c_n + \sum_1^{M-1} \left(c_n \sum_1^n \Delta q_n \right) - q_m c_m = R q_f \sum_M^{N-1} c_n + R \sum_M^{N-1} \left(c_n \sum_1^n \Delta q_n \right) + R q_m \sum_M^{N-1} c_n + R q_m c_m \quad (3:33)$$

or

$$q_f \left(\sum_0^{M-1} c_n - R \sum_M^{N-1} c_n \right) - q_m \left(c_m + R c_m + R \sum_M^{N-1} c_n \right) = R \sum_M^{N-1} \left(c_n \sum_1^n \Delta q_n \right) - \sum_1^{M-1} \left(c_n \sum_1^n \Delta q_n \right) \quad (3:34)$$

which may be written in the form

$$X_1 q_f + Y_1 q_m = Z_1 \quad (3:35)$$

The quantities q_f and q_m are then determined by solving equation (3:30) and (3:35) simultaneously. The summation terms in these equations may be computed in a form similar to table 3-7.

3.13542. *Two-cell, four-flange wing.* If it is assumed for this type of wing (fig. 3-22) that the skin and web members carry shear only, the general equations given in section 3.13541 can be written in the following form:

$$q_f + \frac{A_R}{A} q_m = \frac{M_t}{2A} - \frac{1}{A} \sum_1^3 \left(A_n \sum_1^n \Delta q_n \right) \quad (3:36)$$

$$q_f \left(c_o - R \sum_1^3 c_n \right) - q_m \left(c_m + R c_m + R \sum_1^3 c_n \right) = R \sum_1^3 \left(c_n \sum_1^n \Delta q_n \right) \quad (3:37)$$

These equations may be expressed as follows:

$$X_2 q_f + Y_2 q_m = Z_2 \quad (3:38)$$

$$X_1 q_f + Y_1 q_m = Z_1 \quad (3:39)$$

where:

$$X_2 = 1 \quad (3:40)$$

$$Y_2 = \frac{A_R}{A} \quad (3:41)$$

$$Z_2 = \frac{M_t}{2A} - \frac{1}{A} \sum_1^3 \left(A_n \sum_1^n \Delta q_n \right) \quad (3:42)$$

$$X_1 = c_o - R \sum_1^3 c_n \quad (3:43)$$

$$Y_1 = - \left(c_m + R c_m + R \sum_1^3 c_n \right) \quad (3:44)$$

$$Z_1 = R \sum_1^3 \left(c_n \sum_1^n \Delta q_n \right) \quad (3:45)$$

Then, solving (3:38) and (3:39) simultaneously,

$$q_f = \frac{\frac{Z_1}{Y_1} - \frac{Z_2}{Y_2}}{\frac{X_1}{Y_1} - \frac{X_2}{Y_2}} \quad (3:46)$$

$$q_m = \frac{\frac{Z_1}{X_1} - \frac{Z_2}{X_2}}{\frac{Y_1}{X_1} - \frac{Y_2}{X_2}} \quad (3:47)$$

Example: Referring to figure 3-22 and table 3-7, it is assumed that the following data have been previously determined or given:

$S_e' = +100,000$ pounds.

$S_e' = -10,000$ pounds.

$M_t = -500,000$ inch-pounds.

Δq values, as listed in table 3-7 (determined by sec. 3.1351 (2))

S, t_e , and A values as listed in table 3-7.

$A_F = 2,288$ square inches.

$A_R = 2,912$ square inches.

$A = 5,200$ square inches.

Shear flow values, obtained by substitution of

Table 3-7. Shear-flow computations for typical two-cell, four-flange wing section

	(1)	(2)	(3)	(4)	(5)	(6)	(7)	(8)	(9)
n		J	t_e^0	c_n	Δq_n	$\sum \Delta q_n$	$c_n \sum \Delta q_n$	A_n	$A_n \sum \Delta q_n$
				(2)/(3)		$\sum (5)$	(4) x (6)		(6) x (8)
FRONT CELL	0	157.0	.250	628.0				2,288.0	
	1	85.5	.250	341.8	-2383.7	-2383.7	-814,749	839.0	-1,999,924
REAR CELL	2	26.0	.375	69.3	-459.1	-2842.8	-197,006	1033.5	-2,938,034
	3	82.3	.250	329.2	+584.9	-2257.9	743,301	1040.0	-2,348,216
				$\sum c_n = 740.3$			$\sum (c_n \Delta q_n) = -1,753,056$	$A_R = \sum A_n$	$\sum (A_n \Delta q_n) = -7,286,174$
MIDDLE WEB	m	36.9	1.000	36.9					

NOTE:

①-Shear Modulus of all shear elements assumed to be the same in this case.

$$A_F = 2288$$

$$A_R = 2912.5$$

$$R = A_F/A_R = .7855$$

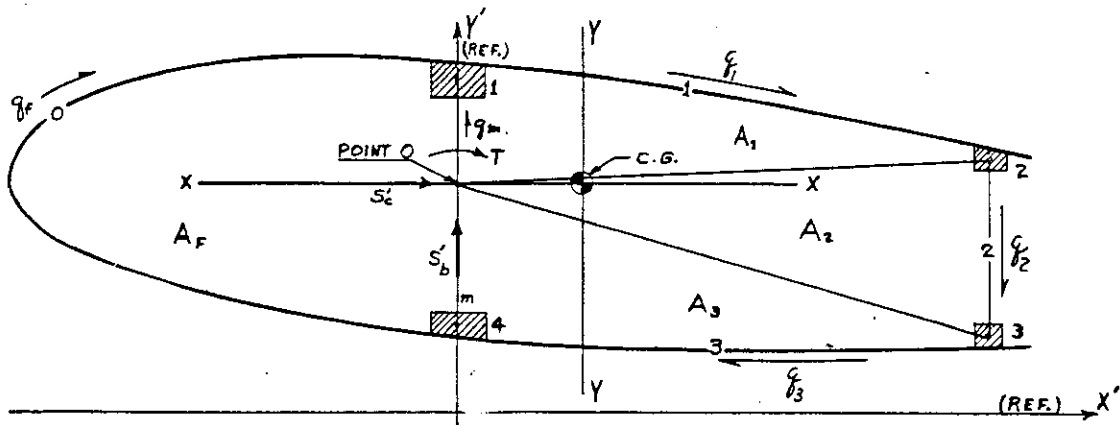

Figure 3-22. Typical two-cell, four flange wing section.

the summations from table 3-7 in equations (3:40) to (3:47) are as follows:

$$q_f = 154.3 \text{ pounds per inch.}$$

$$q_m = 2.140.4 \text{ pounds per inch.}$$

The remaining shear flow values are then determined from equations (3:27) and (3:28):

$$q_1 = -89 \text{ pounds per inch.}$$

$$q_2 = -548.1 \text{ pounds per inch.}$$

$$q_3 = 36.8 \text{ pounds per inch.}$$

3.13543. *Shear centers.* For some purposes, it is desirable to determine the shear center of a wing section. As derived herein, the shear center is defined as the point on a wing section at which the application of a shear load will produce no twist in a differential length of the structure beyond the section. A point so determined is a true shear center for the wing as a whole only if the wing is of constant section throughout the span, or tapers in a manner so that all sections are geometrically similar.

In the following formulas, symbols not expressly defined are the same as in sections 3.13540 and 3.13541.

(a) *Single cell.* Assume that a V load of value P has been applied to the section and the values of Δq for the bending elements computed according to section 3.1351:

$$\text{Twist} = \theta = 0 = \frac{1}{2AG} \sum qc \quad (3:48)$$

$\sum qc$ is found by inspection of figure 3-19 and equation (3:25), resulting in:

$$\theta = 0 = \frac{1}{2AG} \left[q_m c_m + q_m \sum_1^{N-1} c_n + \sum_1^{N-1} \left(c_n \sum_1^n \Delta q_n \right) \right] \quad (3:49)$$

Equation (3:49) is solved for the value of q_m which will produce no twist:

$$q_m = - \frac{\sum_1^{N-1} \left(c_n \sum_1^n \Delta q_n \right)}{c_m + \sum_1^{N-1} c_n} \quad (3:50)$$

Let x = the horizontal distance from the origin O to the load P for the condition of no twist. (That is, x = distance to shear center). Since $Px = M_t$, x may be determined from equation (3:26), as follows:

$$q_m = \frac{P_z}{2A} - \frac{1}{A} \sum_1^{N-1} \left(A_n \sum_1^n \Delta q_n \right) \quad (3:51)$$

$$x = \frac{2A}{P} \left[q_m + \frac{1}{A} \sum_1^{N-1} \left(A_n \sum_1^n \Delta q_n \right) \right] \quad (3:52)$$

where q_m is from equation (3:50) and other terms are computed as in table 3-6.

The vertical location of the shear center may be determined, if desired, by applying a drag load and proceeding as has been shown.

(b) *Two-cell.* It is assumed that a V load of value P has been applied at the shear center which is at an unknown horizontal distance x from the origin O , and that Δq values corresponding to load P have been computed for the bending elements. Since the twist of both cells is zero:

$$\theta_F = 0 = \frac{1}{A_F} \sum qc \quad (3:53)$$

$$\theta_R = 0 = \frac{1}{A_R} \sum qc \quad (3:54)$$

substituting for $\sum qc$, according to section 3.13541:

$$\theta_x = 0 = q_f \sum_0^{M-1} c_n - q_m c_m + \sum_1^{M-1} \left(c_n \sum_1^n \Delta q_n \right) \quad (3:55)$$

$$\theta_R = 0 = q_f \sum_M^{N-1} c_n + q_m \left(\sum_M^{N-1} c_n + c_m \right) + \sum_M^{N-1} \left(c_n \sum_1^n \Delta q_n \right) \quad (3:56)$$

Solving equations (3:55) and (3:56) simultaneously for q_f and q_m will give the values necessary for the condition of no twist. Since P_x is the torsional moment about the origin O , this moment and the value of x may be found from the derivation of equation (3:29), as follows:

$$\frac{M_t}{2} = \frac{P_x}{2} = q_f A + q_m A_R + \sum_1^{M-1} \left(A_n \sum_1^n \Delta q_n \right) \quad (3:57)$$

where the values of q_f and q_m are from equations (3:55) and 3:56). The vertical location of the shear center may be determined, if desired, by applying a drag load and proceeding as in the foregoing.

3.136. *Ribs and Bulkheads.*

3.1360. *Normal ribs.* Normal ribs (those subjected primarily to airloads), in a shell wing, receive the airloads from adjacent skin and stiffeners and redistribute them to the various shear elements of the wing section. The strength of such ribs is always proven by strength tests, but a picture of the stress distribution is useful in rib design and in devising suitable test set-ups. The required airloads, distributed in accordance with the airfoil chordwise pressure distribution, may be considered as the applied loads on the rib, and the shear flows applied by the rib to the various wing section shear elements, oppositely directed, as the reactions. Such shear flows may be determined by performing computations similar to those for the shear flow distribution (using the section method, sec. 3.1351 (2)), after resolving the airloads into resultant forces and a moment, at a convenient reference point.

These conditions may be simulated in a test by constructing a short spanwise section of the wing in which the test rib at one end forms the loading bulkhead, while a bulkhead at the opposite end supports the whole section. The spanwise length, and the attachment of stiffeners and skin to the support bulkhead, should be such that the rib loads are not transmitted directly to the support bulkhead by these elements acting as cantilever beams.

Normal ribs are also subject to a variety of secondary loads, for example: Loads resulting from their function as compression elements when the skin buckles into diagonal-tension fields due to shear; and loads resulting from the axial forces in stiffeners and skin while the wing is deflected in bending.

3.13600. *Rib-crushing loads.* Compressive forces in the upper surface material of the wing, while it is curved upward by bending deflections, produce downward acting loads in the ribs, while the tensile forces in the lower surface produce upward loads, thus subjecting the ribs to compression or crushing in the vertical direction. Where an appreciable portion of the wing-bending material is distributed in the form of skin and stiffeners remote from the beam webs, the rib-crushing loads should be investigated by methods such as reference 3-10 or the following:

$$w = \frac{PL}{R} = \frac{PLM}{EI} \quad (3:58)$$

where:

w = vertical crushing load on rib flange, in pounds per inch of chord.

P = spanwise axial load: in wing surface material due to bending, in pounds per inch of chord, at given point on wing section.

L = rib spacing, inch.

R = radius of curvature of wing due to bending.

M = bending moment on wing section. (M_b from section 3.1331 may be used as an approximation.)

I = moment of inertia of wing section. (I_z from table 3-5 may be used as an approximation.)

E = basic modulus of elasticity used in computing section properties (sec. 3.1330).

3.1361. *Bulkhead ribs.* Bulkhead ribs are described as those that distribute loads of appreciable magnitude, other than air loads, to the wing-section shear elements; for example, fuselage, landing gear, and fuel tank reactions. Such loads, as well as the airloads, may be considered as external loads applied to the rib, and the shear flows applied by the rib to the shear elements, oppositely directed, as the reactions. Here, however, one or more of the conditions required by the shear-flow theory (sec. 3.135) will generally be violated. For example, a larger amount of shear may be absorbed by the elements nearest a concentrated load, depending on their rigidity relative to that of the bulkhead. Conservative overlapping assumptions should therefore be made.

Bulkhead ribs may also perform the function of redistributing shear among the shear elements of a wing wherever some of these elements are discontinued or bending elements redistributed. The shear flows from the outboard wing section may then be considered as the applied loads on the rib, and the shear flows applied to the inboard section, oppositely directed, as the reactions.

Likewise, at a rib where any wing element carrying an appreciable axial load changes direction, the axial loads in the inboard and outboard portions of such an element should be resolved into components parallel and perpendicular to the plane of the rib. The resultant of the components in the plane of the rib may then be considered as a load applied to the rib, with reactions supplied by the wing-section shear elements as described previously.

As a result of the bulkhead analysis, it may be necessary to revise the shear distribution determined in the general shear analysis (sec. 3.135) for local conditions.

3.137. *Miscellaneous structural problems.*

3.1370. *Additional bending and shear stresses due to torsion.* The corner flanges of a box beam are theoretically free from axial (bending) stresses under a pure torque loading, if the cross sections are free to "warp" as the box twists. However, in a shell wing where more than one beam is continuous through the fuselage either directly or through an equivalent structure, bending stresses will be induced in the corner flanges since the opposing action of the opposite wing will restrain the root sections from warping. Additional shear in the short sides of the box is also induced at restrained sections.

In wings not subjected to unusual torque loads and in which the torque cells are continuous and enclose a large part of the sectional area of a reasonably thick wing, the bending stresses at the root due to torsion should be small compared to the total bending stresses for the loading conditions producing maximum bending in the wing.

Analytical methods for computing the bending stress due to torsion in various types of box wings are described in references 3-8 and 3-12. Where the shear rigidity of one wall of a box wing is greatly reduced by a cut-out, the wing torsion should be assumed to be carried as differential bending in the spars in the region of the cut-out. Rational solution of the general case is given in reference 3-6.

Wings in which the torsional stiffness of the torque cells is relatively small because of the small enclosed area or because of many large cut-outs may be conservatively designed as independent spar wings. The effect of the torque cell in relieving the critically loaded spar by transferring part of the load to the other spars may, however, be estimated according to reference 3-7.

3.1371. *General instability.* Reference to section 3.1381 shows that the column length of spanwise stiffeners is generally taken equal to the rib spacing. Such an assumption is valid only when the ribs act as rigid lateral restraints for the stiffeners at the points of intersection. If the ribs lack rigidity in their own planes, allowing the stiffeners to deflect laterally, the axial compressive loads in the stiffeners tend to further increase such deflections because of the resulting eccentricities. If the rib rigidity is too low relative to the axial stiffener (or skin) compressive loads, a state of equilibrium will not be reached, and the ribs and stiffeners will collapse simultaneously. In conventional wings with full depth ribs, the condition described above, known as general instability usually need not be considered. If shallow ribs (at tank bays and wheel wells) or truss-type ribs having shallow flanges are used in wings where a large part of the bending compressive loads are carried in surface material remote from the wing beams, analysis or tests for this condition should be made (ref. 3-14).

3.138. *Strength Determination.* The analytical determination of the strength of the structure is based on a comparison between the computed internal stresses, and the allowable stresses obtained by static test or calculated from the material properties by methods such as those of chapter 2. In order that the computed margins of safety so obtained may represent the strength of the structure with respect to the specified external loads, as accurately as possible, all conditions and assumptions on which both the internal and allowable stresses are based should be reviewed, and any necessary adjustments or allowances made, prior to the final comparison showing the margins of safety. Such allowances may be made by arbitrarily increasing the originally computed internal stresses or decreasing the allowable stresses, in the light of the review.

Some of the factors to be considered in the strength determination are discussed under the following subsections.

3.1380. *Buckling in skin.* For a structure in

which the major portion of the compressive loads due to bending are intended to be resisted by the skin, with the shape being maintained by comparatively light reinforcing structure, the critical buckling and ultimate stresses for the skin, whichever is lower, should be considered as the allowable stress. When buckling does not occur, the ultimate allowable stresses may be computed by the methods of sections 2.60 and 2.61. The criteria of sections 2.70, and 2.80 may be used as guides in predicting the occurrence or nonoccurrence of buckling, but the strength of such structures should be substantiated by static tests of the complete structure, or of a closely similar structure, to ultimate load, because of the uncertainties of buckling phenomena.

For structures in which the supporting and stiffening members are capable of withstanding a major portion of the compressive loads, buckling of the skin does not necessarily result in failure, as discussed in the following subsections on stiffened panels and shear elements. Sharply curved skin panels have much higher critical buckling stresses than flat panels of the same dimensions, but failure in curved panels usually occurs immediately after buckling begins.

3.1381. *Compression elements.* Where secondary stresses, such as those described in sections 3.1330 (5), 3.134, and 3.1370 have not already been taken into account, a reasonable increase in internal stresses should be assumed for critical elements affected thereby. Although wood will yield slightly in compression, tending to relieve the highly stressed fibers, elements which have undergone some crushing in compression may fail at unexpectedly low tensile stresses when the load is reversed.

When light spanwise stiffeners are used to reduce the size of the skin panels rather than to resist the wing bending loads, they need not be designed to withstand the stresses which would be assigned to them as isolated structural elements by the bending theory, provided that such stiffeners are designed to accommodate themselves to the spanwise shortening of the compression side of the wing without failing. At locations remote from the spars, this can be accomplished by making the stiffeners sufficiently flexible so that they can bow between the ribs without failing. Such stiffeners may tend to separate from the skin, however, unless special precautions are taken. At locations adjacent to highly stressed spar flanges this accommodation may be obtained

by using a cross section and material such that local crippling and crushing failure will not occur.

3.1382. *Stiffened panels.* In structures where the skin is expected to buckle below ultimate load and the reinforcing structure is designed accordingly, the allowable compressive stresses may be obtained from section 2.77 or from tests on stiffened panels.

(a) *Effective widths.* In both the allowable and the internal stress computations, an effective width strip of skin adjacent to each stringer is assumed fully effective in compression. The width is often selected arbitrarily, and it is sometimes assumed that the value selected makes little difference so long as the value used in the section-properties computations is consistent with that used in computing allowable stresses from the total load supported by a test panel. This assumption would be true if the upper and lower bending material of the wing consisted only of two symmetrical panels (with the same effective widths in tension as compression) but it may lead to some error if the bending material is not structurally symmetrical and the usual methods of computing section properties are used. Therefore, for structures in which the skin carries a considerable portion of the bending load, the effective widths should be determined as accurately as possible, either by theoretical methods, such as those of section 2.72 and 2.774 or by accurate strain-gage measurements on the test panels. The effective width, $2w$, of plywood panels, is usually expressed as a strip that is considered to act at a stress corresponding to that of the unbuckled plywood at the same *deformation* as the stiffener.

The effective width of metal panels is usually expressed as a strip acting at the same *stress* as the stiffener. The basis for the effective widths indicated in a particular analysis should, therefore, be clearly stated.

(b) *Allowable compressive stresses.* In determining the allowable compressive stress, the various possible modes of failure discussed in section 2.775 should be considered. When the allowable stress is

computed by section 2.72, the stiffener plus effective width of skin is considered as one composite element having an effective modulus of elasticity E' . This procedure was arranged to facilitate checking the stress in any ply or fiber of either plywood or stiffener. Such a composite element may be considered as one item in the section-properties computations (sec.

3.1330), where e_1 will equal $\frac{E'}{E}$ basic.

The computed internal stress, f , for comparison with the allowable will then be: $f=f' \times e$, where f' is the fictitious basic-modulus stress obtained by the bending formulas in section 3.1331, and e is the total element effectiveness factor in accordance with section 3.1330 (5).

When the ribs are sufficiently rigid in their own planes (sec. 3.1371) the column length of the stiffened panels is taken as equal to the rib spacing. In regard to the column-fixity coefficient to be used in conjunction with this column length, it is noted that typical structures show a general tendency to bow inward in the bays between ribs, but a few bays will tend to bow outward. Where one bay bows in and the next out, a fixity of approximately $c=1.0$ is developed, depending on the rotational fixity furnished by the ribs and the degree of buckling and plate or curvature effect of the skin. A value of $c=1.5$ may be assumed if the stringers are fixed to ribs having appreciable bending stiffness in a vertical plane parallel to the stringers. Higher values should not be used in design unless substantiated by tests on a complete structure.

In flat-ended-panel tests, a value of $c=3.0$ or more is usually developed. The results of such tests must therefore be corrected to the fixity values used in the design of the structure.

(c) *Combined stresses.* A convenient method of considering the effects of combined compression and shear in stiffened panels is the stress ratio or interaction curve method, that is, $R_c^m + R_s^n = 1.0$, where R_c is based on the allowable compressive

stress discussed in paragraph (b), and R_s is based on the strength of the panel in pure shear.

The exponents m and n may be assumed equal to 2.0 for panels which are substantially flat, but not more than 1.0 for sharply curved panels, such as in D-nose spars, unless tests are made under combined loads to determine points on the interaction curve. For D-nose spars, tests to ultimate load should be made. A portion of the spar of sufficient length to eliminate end effects, may be used in such tests.

3.1383. *Tension elements.* Tension elements of wood yield very little, compared to metals, before reaching their ultimate strength (sec. 2:16). Unaccounted-for secondary stresses or unconservative assumptions in the stress analysis are therefore likely to cause failures. Since the plywood skin, stiffeners, and spar flanges on the tension side of a wing may not reach their ultimate strengths at the same time, the stresses in each element should be determined and compared with the corresponding allowables. For plywood having the face grain parallel or perpendicular to the spanwise direction, the modulus of elasticity for use in determining section properties and internal stresses may be obtained from section 2.52, or table 2-13, and the allowable tensile stress from section 2.601, and table 2-13. For plywood having the face grain at an angle to the spanwise direction, the spanwise modulus of elasticity may be obtained from section 2.56.

The allowable tensile stress for such 45° plywood may be obtained from section 2.611 and table 2-13.

When the plywood on the tension side does not buckle due to shear, which is usually the case on a wing (sec. 2.73), the condition for failure under combined tension and shear may be determined by stress ratios in accordance with section 2.613.

3.1384. *Shear elements.* When the shear flow, q , has been determined, the internal shear stress is obtained by dividing q by the actual thickness of the element, even though an effective thickness based on relative moduli of rigidity was used in the shear distribution analysis. The allowable shear stress values given by section 2.73 are directly applicable to beam webs and allow for the effects of the beam bending stresses near the flanges.

These allowable shear stresses should also be applicable to substantially flat wing skin panels in the same range with respect to buckling. The ultimate strength of curved panels in shear must at present be obtained from tests on specific structures as described in section 3.1382 (c), since buckling usually precipitates failure.

3.2 Fixed Tail Surfaces

The procedures applicable for use in the stress analysis of fixed tail surfaces (fin and stabilizer) are analogous to those described in section 3.1 for the analysis of wings. The nature of the applied loads is necessarily similar in that the source is principally aerodynamic and the spanwise and chordwise distributions of the same are similar to those over wing surfaces. The loads resulting from inertia effects require a consideration similar to that employed in the analysis of wings. The dependence of the applicable type of analysis upon the structural arrangement of the material is also similar to that encountered with wings and this consideration is treated in section 3.1. The strength of the structure is determined by comparison of the calculated internal loads and stresses with the allowables which are obtained either from tests or from the information given in chapter 2. The determination of the strength of shell structures, including reinforced shells, is presented in detail in section 3.138.

3.3 Movable Control Surfaces

The movable control surfaces are ordinarily comprised of the ailerons, elevator, and rudder. The analysis of each of these surfaces is fundamentally the same basic problem. Each movable surface consists of an airfoil free to rotate about a hinge axis fixed on the supporting structure except as restrained by the control system at its attachment point (control horn). The essential structure is made up of the:

- (1) *Airfoil surface* (fabric or plywood plating) upon which the air forces act and are transmitted through
- (2) *Surface attachment means* (lacing, nails, or glue) to the
- (3) *Ribs*. The ribs transfer the air loads through shear and bending to the
- (4) *Main beam* and
- (5) *Torque tubes*. The beam and torque tube are supported by the fixed surface structure at the

(6) *Hinges* where the transverse shear is transmitted to the fixed surface. The torque tube carries the torque resulting from the air loads and hinge support reactions to the

(7) *Horn*, where it is balanced by the control system reactions.

A satisfactory analysis should include a check of the plating material (fabric, plywood) under the imposed design pressure loading. Unit pressure loadings, consistent in magnitude with those encountered over deflected control surfaces should be considered in such a check. The strength of the surface attachments should be checked in combination with that of the surface material itself. The most satisfactory method of determining the strength of such structural items is by "blow-off tests" of panels representing the type of construction employed (simulating rib spacing, surface attachments) when subjected to test pressures representing the design loadings. Critical surface pressures are usually negative (tending to blow the surface outward).

Ribs may be considered as cantilever beams supported at the main beam or torque tube and supporting the pressure loading over the area extending approximately midway to adjacent ribs. Here again static tests of representative structures constitute the preferred basis for proof of satisfactory strength.

The main beam and torque tube should be checked under the shear, bending, and torsional loads resulting from the rib loadings, and the reactions at the hinge supports and the control horn. When the main beam or torque tube is continuous over three or more hinge supports, the deflection of the fixed surface or wing under flight loads should be taken into account by introducing suitable deflections of the supports into the three moment equations or by conservative overlapping assumptions. Irregularities and discontinuities of such structures are often encountered because of the cut-outs necessary for the control surface hinges. Care should be exercised to provide adequate strength and rigidity in way of such cut-outs by means of proper reinforcing and by use of conservative assumptions both as to stresses developed and stresses allowed. This is especially necessary in wood structures because of the inherent inability of wood to equalize stress concentrations through considerable plastic deformation.

3.4 Fuselages

3.40. General. Most of the commonly used types of wood fuselage construction fall within one of the following:

- (1) Four-longeron type.
- (2) Reinforced shell (semimonocoque) type.
- (3) Pure shell (monocoque) type.

Examples of these types are included in the sketches shown herein under the pertinent sub-headings. A particular airplane fuselage need not necessarily be confined to one type of construction but may employ any applicable combination. For example, the stiffened-shell type may revert to the four-longeron type in way of large cut-outs such as cockpit openings, or bomb bays.

3.41. FOUR-LONGERON TYPE. The treatment of the four-longeron type is somewhat analogous to that of the D-section and single-cell shells as described in section 3.13 with the additional simplification that results from the inherent symmetry of the typical fuselage section. In both, the material effective in bending is concentrated into a small number of locations and the section properties for use in a bending analysis may be calculated in the normal manner as based upon such an assumption. The plywood shell material will actually contribute in some indeterminate extent to the bending strength of such four-longeron-type sections as are illustrated in figures 3-23 and 3-24. However, it is probable that, on the compression side, this contribution will be limited to approximately that corresponding to the buckling load for the plywood panels as determined from the transverse frame spacing, panel thickness, species, arrangement of plies, and curvature according to the methods described in chapter 2. In this type of construction, the unit deformation corresponding to the maximum design stress in the longerons very probably exceeds by far that corresponding to the buckling stress of the adjacent plywood material and of that farther removed from the neutral axis. Also, without curvature and without longitudinal stringers between longerons and the smaller plywood panel expanses and greater buckling stresses resulting therefrom, the design shearing stress in the sides of the four-longeron-type section will also probably exceed the buckling values by a considerable amount.

Both of these tendencies lead to the conclusion that it is satisfactorily conservative to neglect the contribution of the plywood shell to the

bending properties in cases where the buckling stresses of such shell material is considerably exceeded by the longeron stresses and shear web stresses calculated on the basis of zero contribution (fig. 3-23). In any event, the optimum contribution of the shell material that could be expected would be that corresponding, on the compression side, to the buckling stress of the panels and, on the tension side, full effectiveness. In this connection, the designer's attention is directed to the existing knowledge of the behavior of thin panels subsequent to buckling. With flat panels and panels of slight curvature (that is, those in which the contribution of curvature to the buckling load is not significant) a load approximately equal to the buckling load is maintained after buckling. With thick plates of considerable curvature (that is, those in which the contribution of curvature to the buckling load is appreciable) the load tends to drop off after buckling. In such panels, rupture is also much more likely to result at buckling. For these reasons, it is desirable that under the ultimate design loads, the stresses resulting in such a portion of a compression flange do not exceed the critical buckling stresses. On the tension side, the contribution of the plating should be taken as that corresponding to an equivalent area of the plywood flange in terms of the longeron material (fig. 3-24). For purposes of calculation, the equivalent effective area (or thickness) of the tension plywood flange would be equal to $t \times \frac{E_2}{E_1}$

where t =plywood thickness, E_1 =modulus of elasticity of longeron material in a direction normal to the section, and E_2 =modulus of elasticity of plywood material in a direction normal to the section. These definitions are different from those used in chapter 2.

In determining the optimum effectiveness of the compression plywood material, it is emphasized that the total load carried by the material would be approximately limited to the buckling load rather than being proportional to the total load upon the section. If it is considered permissible for the subject panel to buckle at the design load, the effective thickness for use in computing section properties may be taken as approximately $t \left(\frac{F_{cr}}{F} \right) \left(\frac{y_1}{y_2} \right)$, defined in figure 3-24. If it remains unbuckled the corresponding effective thickness may be taken as $t \left(\frac{E_2}{E_1} \right)$. The applicable pro-

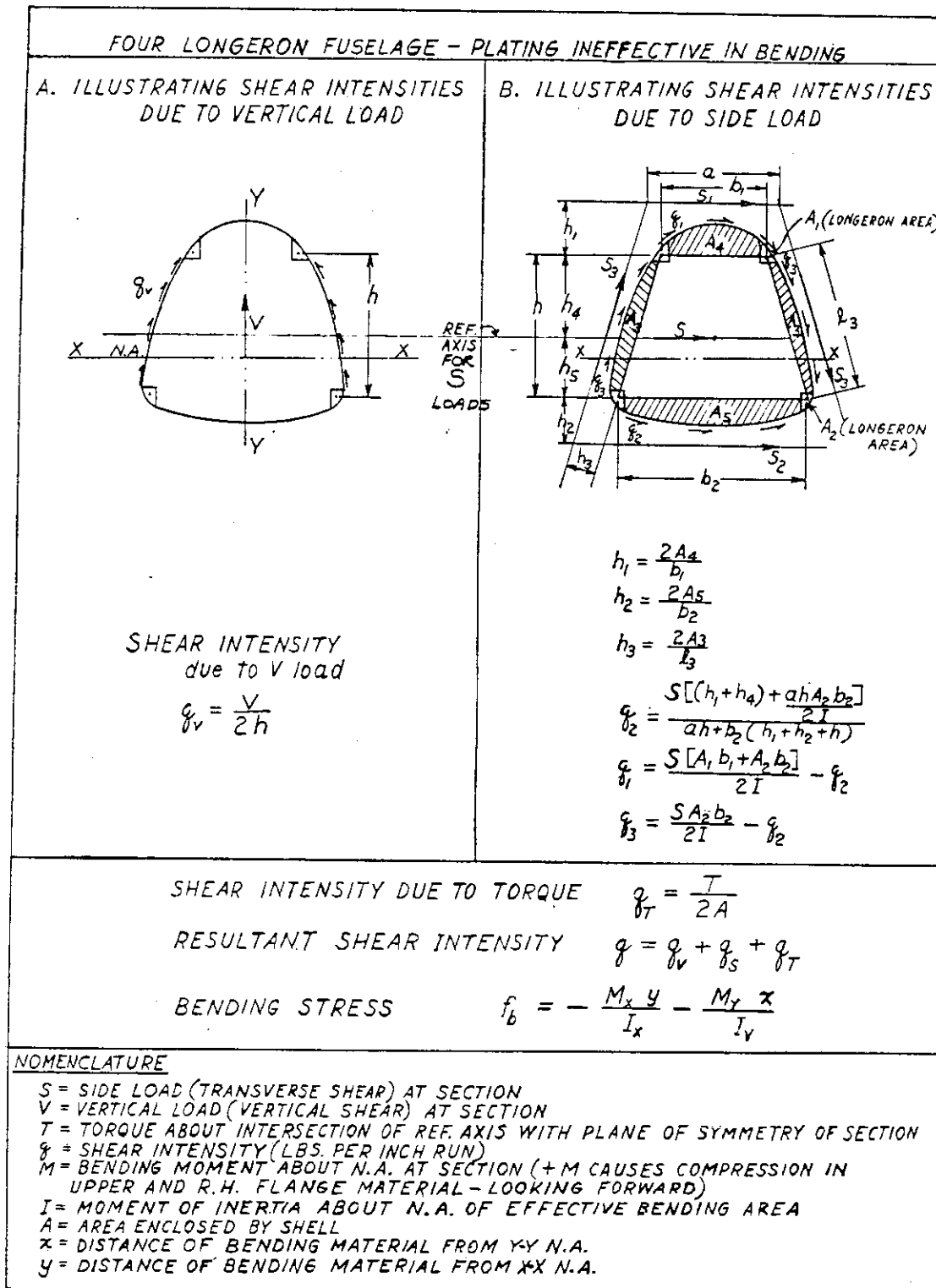

Figure 3-23. Four-longeron fuselage—plating ineffective in bending.

cedure must be checked by computing the actual stress in the plating and comparing it with F_{cr} . The resultant external applied loads on the section in question should be resolved into:

- (1) Vertical shear (in plane of symmetry).
- (2) Transverse shear (at reference point determined by fig. 3-23).

- (3) Moment about each of the principal section axes.
- (4) Torque about reference axis (for example, the intersection with the plane of symmetry of the transverse reference axis defined by fig. 3-23).

The plywood panels (sides, top, and bottom)

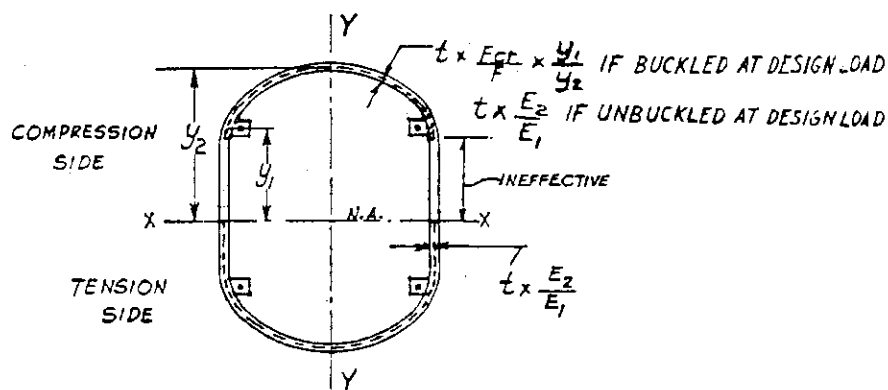

A. PARTIALLY BUCKLED SHELL

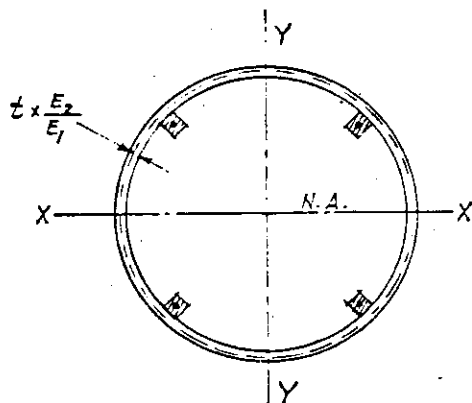

B. UNBUCKLED SHELL

F_{cr} = PANEL BUCKLING STRESS

F = LONGERON ALLOWABLE STRESS

E_2 = MODULUS OF ELASTICITY OF PLYWOOD NORMAL TO SECTION

E_1 = MODULUS OF ELASTICITY OF LONGERON NORMAL TO SECTION

Figure 3-24. Four-longeron fuselage—plating effective in bending.

can be considered to carry the shear upon the section, both that due to the vertical and transverse loads and that resulting from torsion. When the flange material is concentrated in the longerons, the shear intensity (pounds per inch run) can be considered constant between adjacent flanges. The shear intensity, and thus the shear stress, may then be determined by figure 3-23 without the use of the shear center. Such center may be determined, if desired, by the methods of reference 3-11. Calculations made in connection with the application of the thin-shell theory,

developed primarily for use with isotropic metal materials, should be modified to account for variations in the modulus of rigidity (G) for the various wood panels as affected by wood species, direction of grain, relative thickness and arrangement of plies, according to the methods described in chapter 2.

If the shell thickness, curvature, and frame spacing are such that the buckling stresses will not be exceeded under conditions of maximum loading, the section properties may be calculated using the full shell area as modified to correspond

to equivalent longeron material, that is, the proportionate amount of effective shell material, in terms of longeron material, is equal to $\frac{E_2}{E_1}$ as previously described. When the section properties are thus calculated on the basis of longeron material, the bending stress in the longerons is determined in the usual manner.

$$f_1 = \frac{My_1}{I} \quad (3:59)$$

where y_1 is the distance of the longeron material from the neutral axis. The bending stress in the plywood material, however, is determined as

$$f_2 = \frac{My_2}{I} \times \frac{E_2}{E_1} \quad (3:60)$$

where y_2 is the distance of the subject material from the neutral axis.

The possible variety of assumptions made to facilitate analysis can be considerable and will, to a large extent, be determined by the individual details of the problem together with the designer's experience, judgment, and discretion. An adequate supplementary static-test program is required, and it is also essential that the assumptions used in converting the test data into allowable loads and stresses be duplicated in the stress analysis of the flight article.

3.42. REINFORCED-SHELL TYPE. This type of construction is very broad in nature and covers the field extending from the longeron type with large longerons and thin shell to the type approaching the pure shell, that is, small longitudinals and thick shell.

3.421. Stressed-skin fuselages. Stressed-skin fuselages usually are structures of the reinforced-shell, single-cell type, and the basic methods of wing analysis, as described in section 3.13 generally can be applied directly to the analysis of such fuselage structures. Due to variations of the type of loading and certain other structural problems, however, it is considered advisable to review the fuselage analysis problem as a separate subject.

Unless a fuselage of this nature conforms closely to a previously-constructed type, the strength of which has been determined by test, a stress analysis is not considered as a sufficiently accurate means of determining its strength. The stress analysis should be supplemented by pertinent test data. Whenever possible, it is desirable to test the entire fuselage for bending and torsion, but

tests of certain component parts may be acceptable in conjunction with a stress analysis.

3.422. Computation of bending stresses. Prior to computing the bending stresses, it is necessary to compute the fuselage-section properties. As was previously recommended in section 3.13, it is considered advisable to make a sketch of the fuselage section considered. This sketch should indicate all of the material assumed to be effective. Figure 3-25 is a sketch of a fuselage cross section of the subject type.

On the tension side of the fuselage the skin material may be assumed to be acting as discussed in the following, while, on the compression side, only the effective width of skin (section 3.1382) adjacent to the stiffener should be assumed to be acting. In general, the modulus of elasticity of the plywood plating will differ from that of the stiffener material. Account of this fact must be taken in calculating the section properties. This may be done by converting the actual area of the plating on the tension side into that of equivalent stiffener material, either in terms of equivalent thickness or equivalent widths—the latter being somewhat analogous to the effective width as used on the compression side. The geometrical shape of the section contour together with the arrangement and spacing of stiffener material will dictate which method of treatment is analytically simpler or more accurate. The proportionate effectiveness of the plating material in tension may be taken as $\frac{E_2}{E_1}$ as described previously under section 3.42.

Proper account for wood species, plywood grain attitude and arrangement, and veneer thicknesses should be taken into account according to the procedures described under section 2.77. The determination of bending stresses by means of the $\frac{My}{I}$ formula implies the assumption of plane sections remaining plane sections. Hence, the calculated stresses in the plating material, as based upon section properties determined by conversion of plating material into equivalent stiffener material, must also be modified in the ratio $\frac{E_2}{E_1}$. The resulting corrected stresses in the plating must be compared with the allowable tensile stresses in the plating material as described in section 3.1383. Such a check should always be made of plywood material adjacent to highly stressed stiffener material, even where the contribution of such plywood material has been completely neglected in

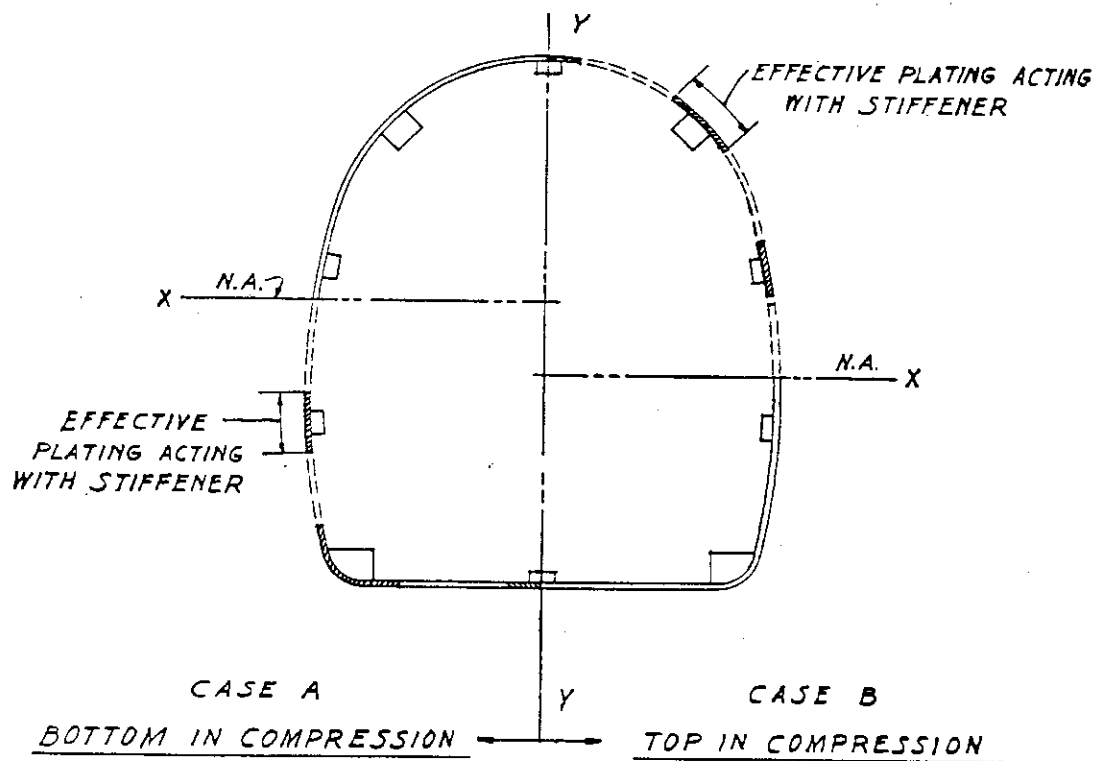

ILLUSTRATING TREATMENT OF MATERIAL
EFFECTIVE IN BENDING ABOUT X-X AXIS

Figure 3-25. Reinforced shell fuselage.

the determination of section properties. In order to account for the effect of shear on the effective widths for stiffeners on the side of the fuselage, it is advisable to compute the effective widths for all stiffeners on the compression side on the basis of a panel edge stress corresponding to the allowable stress of the stiffener, rather than the actual stress to which it may be subjected. It is customary to assign to each stiffener and adjacent skin an item number. Prior to actual computations, the designer should make an estimate of the neutral axis location, thereby dividing the elements into those on the compression side and those on the tension side. After the location of the true centroid of the section has been determined, the designer will be able to check the accuracy of his original assumptions as to neutral-axis location.

It usually will be found that no corrections for axis location are necessary if the final axis is located relatively close to the one originally assumed. A procedure similar to that described in section 3.1330 will be found convenient for computing the section properties. Distances and moments originally are taken from some conveniently located reference axis. The sum of moments about the reference axis, after being divided

by the sum of the areas in the section, gives the location of the neutral axis of the section. Distances of the items from the neutral axis are then determined. The sum of the products of the areas located on either side of the neutral axis multiplied by the distances to the neutral axis is equal to the static moment of the section about the neutral axis, Q , and the sum of second moments of all of the elements of the section is equal to the moment of inertia of the section, I . Where the axial loads produce appreciable values of bending moments on the fuselage, these moments should be included in the bending moment, M , which is used to obtain the axial stresses due to bending.

Critical stresses commonly are assumed to occur at the stiffeners located farthest away from the neutral axis on the compressive side, and the stresses in these stiffeners resulting from bending are computed by the $\frac{My}{I}$ equation, M being the critical moment at the section and y being the distance of the stiffener from the neutral axis.

Although the bending theory indicates that the outermost fibers are the critical ones, it will often be found that stiffeners located near the top or bottom, on the shoulders of the section, are the ones which are liable to fail during tests if the

skin buckles in shear. Such stiffeners usually are subjected to comparatively large direct stresses due to bending and, at the same time, may act as the stiffeners of the tension-field shear material transmitting the shearing stresses to the outermost stiffeners. Unless these stiffeners are of sufficiently large proportions to resist the bending loads imposed by the tension-field effects, failures of these stiffeners may occur at loads smaller than anticipated.

3.423. *Computation of shearing stresses.* The bending material in fuselage sections usually is distributed in such a manner that under symmetrical loadings it may be safely assumed that each side carries half of the vertical shear load, and the corresponding shearing stress, f_s , at any point is equal to $\frac{VQ}{2tI}$, where V =the shear force acting on the section, Q =static moment about the neutral axis of the areas located between the outermost fibers and a horizontal line through the point under consideration, I =moment of inertia of the section, and t =thickness of the skin at the point under consideration.

The sum value, Q_x (table 3-5), should be used for determining the maximum shearing stresses that occur at the neutral axis of the fuselage. Although these methods pertain to the analysis of the fuselage for a shear load applied in a vertical direction, similar methods can be employed for a shear load applied horizontally, such as a side load on the vertical tail. If the structure is not too unsymmetrical about a horizontal plane, the shear center for application of the horizontal load may be estimated, using overlapping assumptions. If a more exact solution of shear distribution is desired, the methods of section 3.135 may be used. The total shear stress (or intensity) at any section is that obtained from the superposition of the component shear stresses (or intensities) resulting from vertical loads, transverse loads, and torsion.

Although the fuselage structure as a whole should be checked for the shear distribution as determined in the foregoing, it is recommended that certain sections of the fuselage be checked for other types of shear stress distribution that may be more in line with the actual load application. At the point of wing attachment to the fuselage, for example, very large loads are transmitted to the fuselage frame through the attachment fitting. It is reasonable to assume that high shearing stresses will be present near this fitting, gradually tapering to the extremity of the frame.

Although this assumption is not in agreement with the conventional bending theory, it is recommended that it be considered in design to allow for probable shear concentrations.

Torsional shear stresses can be computed by the conventional formula $f_s = \frac{T}{2At}$ and should be combined with the stresses due to direct shear. The tendency of tension fields to sag the stiffeners also should be considered. Because similarity seldom exists between the geometric properties of different airplane structures, it is difficult to draw conclusions from one design as to the allowable shear stresses to be used for other designs. It is usually necessary, therefore, to conduct panel tests on representative curved shear panels.

3.43. *PURE-SHELL TYPE.* By definition, the pure shell or monocoque type of structure incorporates no longitudinal stiffening members. Hence, the ultimate strength of such a structure may be taken as the critical buckling strength of its elements. As described in chapter 2, the buckling strength of a plywood panel may be estimated from its thickness, frame or stiffener spacing, wood species, arrangement of plies, and curvature. It is generally desirable that no portion of the structure become buckled prior to the application of the design load. In such a case, in the calculation of section properties, the material may be considered fully effective and the stresses determined according to the fundamentals of mechanics.

In a section such as shown in figure 3-26B, however, certain portions may become buckled at low loads without materially affecting the final load-carrying capacity of the total section. This may be exemplified by the buckling of flat panels on the compression side while the major portion of the total flange material is unbuckled by reason of its difference in curvature or thickness. It is generally satisfactorily conservative to omit the buckled material from consideration. Such a partially buckled structure must, of course, be adequately stiffened by frames.

3.431. *Monocoque-shell fuselages.* The basic principles of the design of thin-walled cylinders, as discussed in ANC-5 sections 1.63 and 1.64 can be applied to the design of monocoque fuselages. The monocoque portion of the fuselage structure usually is restricted to certain sections of the fuselage, such as the tail portion. In the center and in the forward portions of the fuselage, the reinforced-shell type of construction, which is more suited to the region where cut-outs are present,

generally is used. Careful attention should be given to that part of the fuselage structure where two types of construction join. Adequate length and attachment of the reinforcing members to the shell should be provided. At the points where the monocoque section stops at cut-outs, transfer of the load from monocoque portion to the stiffeners around the cut-out should be investigated carefully (ref. 3-19).

Tests of monocoque fuselages have demonstrated that the strength is dependent to some extent on the smoothness of the plating. The designer should, therefore, be certain that the methods of assembly of monocoque fuselages in the shop will produce a satisfactory product. Where small margins of safety are present and when the effects

of load concentrations have not been taken into account conservatively, strength tests should be carried to the full ultimate-load values, because the type of failure in this type of structure usually is elastic, and the appearance of the structure under proof load may be no indication of the ability of the structure to carry the required ultimate loads.

3.44. MISCELLANEOUS FUSELAGE ANALYSIS PROBLEMS. Each new type of fuselage may present a new set of problems which has not occurred in other types. It is recommended, therefore, that every new type of fuselage be tested at least to the critical ultimate loads to determine the presence of possible stress concentrations and other effects which could have been overlooked in the most careful design. Some of the analysis problems which are somewhat common to all types of fuselages are discussed in the following sections.

3.441. *Analysis of seams.* The allowable loads of the seams should be computed and compared with the loads imposed by direct tensile stresses, by shear stresses, by any tension field effects of the shear stresses, and by combined stresses due to the action of all these stresses.

3.442. *Analysis of frames and rings.* The analysis of the fuselage frames constitutes a separate problem. Many manufacturers have adopted certain standard methods of frame analysis, which, although not necessarily mathematically rigorous for the types of the structures considered, have produced satisfactory designs. A general discussion of some of these methods is given.

3.4421. *Main frames.* Main frames are primarily for the purpose of distributing into the fuselage such concentrated loads as the loads from wings, tail surfaces, or landing gear, and those resulting from the local support of items of mass. Main-frame structures usually are of the redundant type and their analysis is based on the principles of least work and related or equivalent methods such as strain energy, column analogy, moment distribution, or joint relaxation (refs. 3-2 and 3-3).

Figures 3-27 A, B, and C show a fuselage main frame under a symmetrical loading condition. The loads from the wing (or landing gear) are shown applied at the applicable fittings and are resisted by shear forces in the fuselage skin. To agree with the elementary bending theory, these shear intensities should be distributed so as to

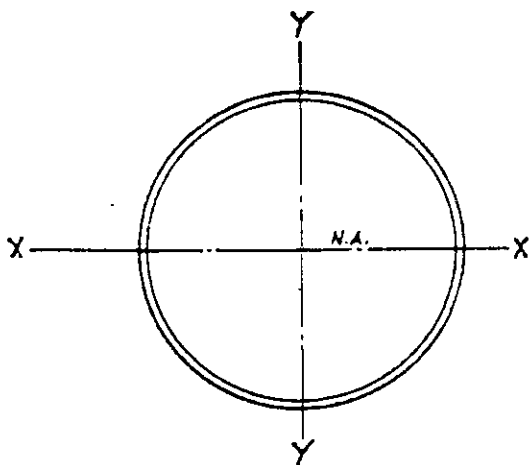

A. UNBUCKLED (FULLY EFFECTIVE)

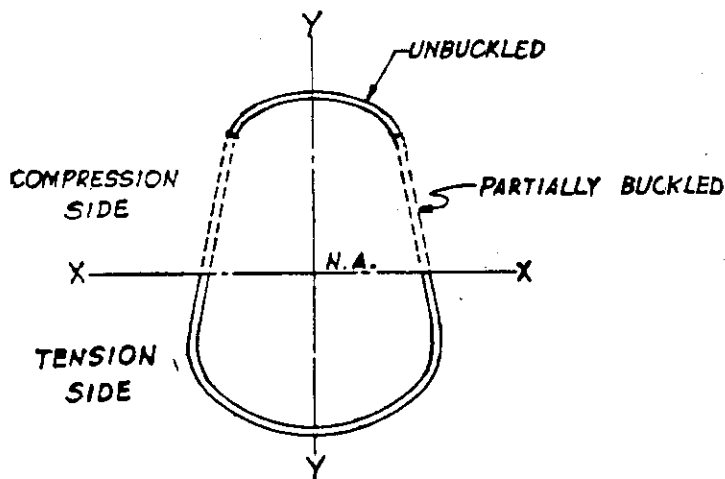

B. PARTIALLY BUCKLED

Figure 3-26. Pure shell-type fuselage.

conform to the $\frac{VQ}{2I}$ or $\frac{V}{2h}$ values of the fuselage section, as applicable, giving a distribution of shear forces of the type shown in figure 3-27 A or B. Some designers take into account the fact that, due to concentration of load where the frame is attached to the wing, the shear is carried mostly by the adjacent fuselage skin and the shear resistance of the skin is reduced arbitrarily, somewhat in proportion to its distance from the point of concentrated load application. This would yield a shear force distribution of the type shown in figure 3-27 C. In such cases, the fuselage skin should also be checked for the high stresses indicated.

The ordinary method of frame analysis is strictly applicable to frames the deflections of which are not restricted by the fuselage skin. Actually, the frame deflections may become quite pronounced and the outward deflections are resisted by double-curvature effects in the fuselage skin or by the support of adjacent frames. This action of the skin is equivalent to introduction of inward-acting loads resisting the frame bending and hence to a reduction of frame stresses to smaller values than those indicated by an analysis based upon shear distributions as described. The present development of the theory does not indicate quantitatively just what allowance can be made for this reduction of stresses. It is recommended, therefore, that the frame analysis be conducted by the methods similar to the ones indicated.

Where relatively deep frames are used, the moments induced by the wing deflections may become important and should, therefore, be analyzed.

3.4422. *Intermediate frames.* Intermediate frames are provided to preserve the shape of the fuselage structure, to reduce the column length of the stiffeners, and to prevent failure of the structure due to general instability. They are subjected to several types of loading; such as, those due to tension fields in the skin, to fuselage bending, to transfer of shear to the fuselage plating. Many of these loads are comparatively small and often tend to balance each other. For these reasons the design of intermediate frames is often based on the experience of the designer or on semi-empirical methods. In the case of large airplanes, however, it becomes of considerable importance to design frames of this type to provide suitable stiffness for the prevention of general instability.

3.443. *Effect of cut-outs.* Effects of cut-outs usually are allowed for by omitting the bending material affected by the cut-out from the computation of the section properties. For shearing stress computations in the location of regularly spaced cut-outs, such as windows, the shear stress in the skin between cut-outs may be taken as equal to that computed on the assumption that no cut-outs are present and then increasing this value by the ratio of distance between cut-out centerlines to the distance between the cut-outs. Such treatment, although quite arbitrary, has served satisfactorily with metal material. Because of the inherent lack of ductility in wood and its inability to deform plastically and redistribute stresses adjacent to local concentrations such as cut-outs, the incorporation of large calculated margins of safety is recommended in such locations.

In case of large openings, such as the cabin door cut-outs, allowance for bending stress redistribution usually is made by modifying the section properties by omitting the material affected by the cut-out. For computation of the shearing stresses, it may be assumed that the direct shear load is carried through that side of the fuselage not containing the cut-out. The couple resulting from this unsymmetrical reaction in way of the cut-out can be assumed to be resisted by a shear couple consisting of equal and oppositely directed transverse reactions in the top and the bottom of the fuselage. The redistribution of the shear stress, as assumed, can be achieved best if bulkheads are provided on both sides of the door. Where only one main bulkhead is provided (at only one end of the cut-out) shear redistribution on the other side of the cut-out must be accomplished by the frame under the flooring and by the intermediate frames. Reference 3-19 describes the basic theory and recommended methods of determining the shear distribution in the plating about cut-outs, and also the corresponding effect of the cut-outs upon the loads in the stringers and frames.

3.444. *Secondary structures within the fuselage.* Often the designer is faced with the problem of existence of a secondary beam structure inside the main fuselage or hull structure. This secondary structure may consist of keels or keelsons in a flying-boat hull, or of the floor supporting structure or nose-wheel retracting tunnel in a fuselage. If this type of structure is analyzed separately under the specified local loads alone, the stress distribution may not correspond to the distribution that will be obtained with it acting in conjunction with

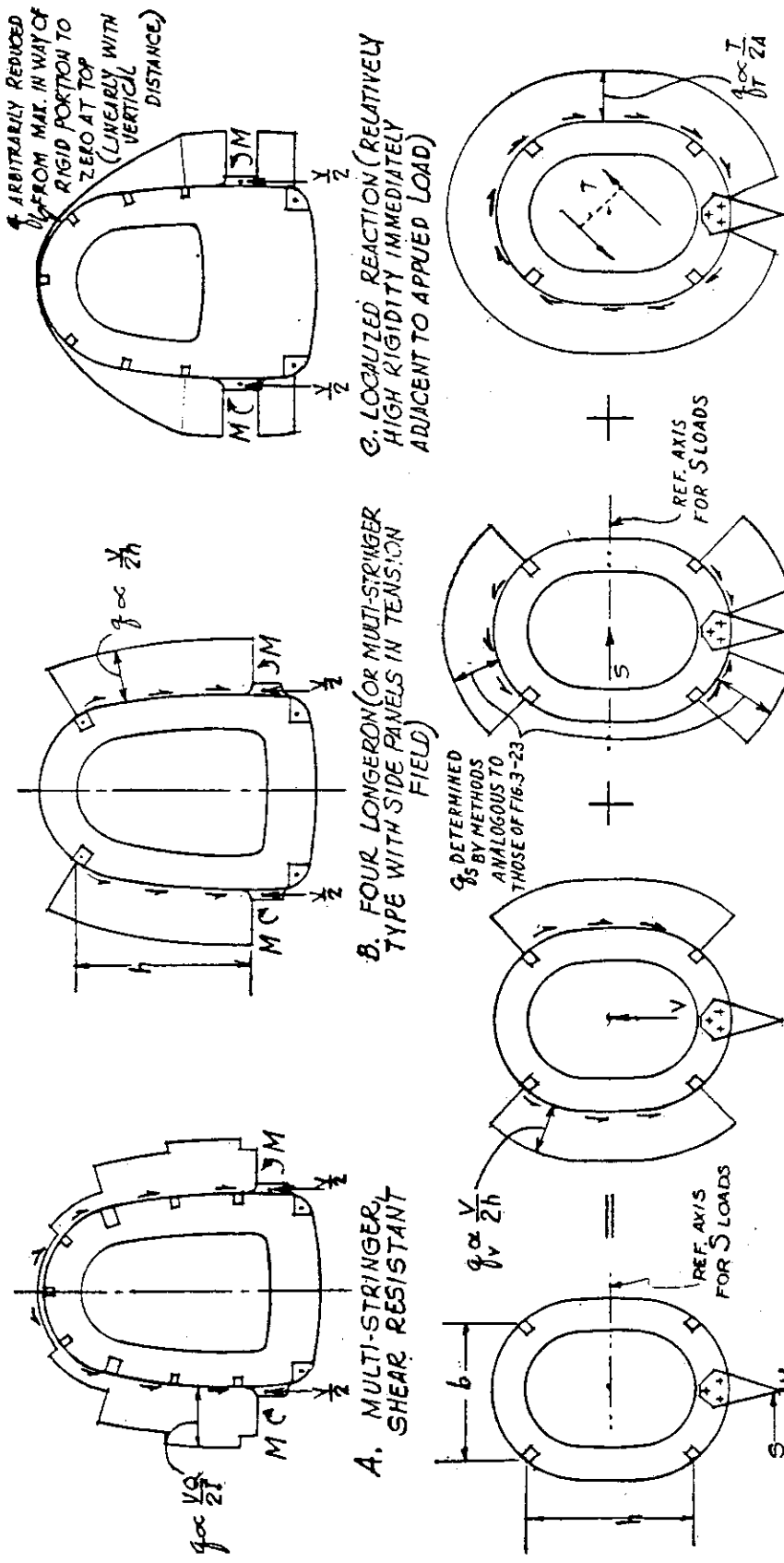

1. q = SHEAR INTENSITY OF REACTIONS PROVIDED BY PLATING PLOTTED AS AN ORDINATE NORMAL TO THE PLATING.

2. A, B, AND C REPRESENT A FRAME UNDER SYMMETRICAL FLIGHT (OR LANDING) LOADS.

3. D REPRESENTS A FRAME UNDER UNSYMMETRICAL LOAD (SUCH AS AT TAIL WHEEL).

4. LOADS ON FRAME RESULTING FROM LOCALLY SUPPORTED MASS ITEMS ARE NOT SHOWN — BUT SHALL BE CONSIDERED AND PROPERLY BALANCED.

5. PLATING IN WAY OF FITTINGS HAS BEEN SHOWN AS INEFFECTIVE. ALL SHEAR INTENSITIES DETERMINED BY ASSUMING PLATING FULLY EFFECTIVE ARE INCREASED PROPORTIONATELY TO OBTAIN EQUILIBRIUM.

N 41716 F

Figure 8-27. Shear distributions applicable to frame design.

the rest of the fuselage structure. The designer should make certain that the combined effects of the two structures are in agreement and that the action of the structure as a whole is consistent with expected deformations.

3.45. **STRENGTH DETERMINATION.** The strength of the structure is determined by comparison of the calculated internal loads and stresses with the allowables obtained either from tests or from the information given in chapter 2. The determination of the strength of shell structures, including reinforced shells, is presented in detail in section 3.138.

3.5 Hulls and Floats

The analysis of hulls and floats may be treated in a manner similar to that used with fuselage structures, the chief difference being in the manner in which the major external loads are applied, that is, by direct contact with the water in the form of normal pressures. Fundamentally, hull and float structures consist of:

- (1) *Bottom plating*—that, in contact with the water, is loaded by the normal pressures developed in landing, take-off, or buoyancy, and transfers such loads to the—
- (2) *Bottom stringers*—that support the plating and transfer the plating loading to the supporting—
- (3) *Frames*—that in turn carry the water loads through to the—
- (4) *Main longitudinal girder*— or general structure. Consideration is given to the fact that water causes concentrated local loads on float and hull bottoms that may reach intensities considerably above the average loading and may be applied at different times and for different durations to different portions of the bottom structure. For these reasons the strength requirements for design of the bottom plating are specified as more severe than those for stringer design. The bottom stringer strength requirements are, in turn, more severe than those for complete frame design. The specified loads as applicable to the design of the general structure are in general of lesser local intensities but are consistent with the design airplane accelerations and total reactions.

3.51. **MAIN LONGITUDINAL GIRDER.** This structure may consist of a centerline truss or bulkhead

girder to which the frames, deck, side and bottom plating are attached. Or, the deck, side, and bottom plating and stringers plus other longitudinal material connecting to, and capable of acting with, the skin plating and stringers may be considered as a reinforced shell which comprises the longitudinal girder. In such a structure the frames not only serve to transmit the water loads to the general structure, but provide the transverse and circumferential stiffening for the shell. The effective longitudinal members ordinarily considered to take the bending loads consist of: keel, bottom stringers, keelson, chine, deck, and stiffeners. The effective shear material consists of side, deck, and bottom plating. The analysis assumptions, calculation of section properties, and determination of normal and shearing stresses applicable to the longitudinal girders are in general as described under section 3.4 for fuselage analysis.

3.52. **BOTTOM PLATING.** Thin plating, when subjected to sufficient normal pressures will either rupture or deflect excessively and take a permanent set. In hulls and floats this latter effect is known as "wash boarding," and in an acceptable structure should not be allowed to occur at loads below those corresponding to yield-point loads. For this reason the design criteria established by the procuring or certificating agency in general consists of specification of certain design-bottom-pressure loadings in conjunction with the permissible permanent deformations at the specified pressure loadings. Permanent deformation is measured at the center of the plating panel, between stringers and relative to the stringers, in a direction normal to the plane of the plating.

The analytical determination of bottom-plating stresses and deflections is exceedingly difficult of accurate attainment, and the problem of design calculation methods, including the basis for allowable stresses, hence lends itself most readily to treatment by testing procedures. Test panels representative of (1) the plating species, thickness and plywood type, (2) the stringer spacing, frame spacing, and panel aspect ratio, and (3) method of edge support and type of edge restraint should be tested under normal pressures, and the applicable strength criteria (ultimate strength, arbitrary or true yield, and permanent deformation) determined. Test data may be interpreted and converted in light of the calculation procedures described in chapter 2.

In such a treatment, two of the influential fac-

tors that determine the calculated stresses and deflections are (1) type of edge support, and (2) aspect ratio of panel. Clamped or fixed edges assume the plating to be restrained from any rotation at the edges, the neutral plane of the plywood maintaining zero slope. In simply supported edges, conversely, a possibility of rotation of the neutral plane of the plywood at the edge is implied. The plates actually encountered in the design of floats and hulls lie somewhere between fixed and supported edges and may be considered as elastically restrained. The maximum stress in a plate with fixed edges occurs at the long edges, whereas it occurs in the middle of a plate with simply supported edges. It follows from this that a slight deflection or twist of the fixed edges of a plate will decrease the stress close to the edges where it is a maximum and increase it near the middle where it was, however, originally much less. Bottom stringers are not ordinarily very stiff torsionally and constitute a type of support bordering upon the simply supported edge. On the other hand, keel, keelson, and chine members are necessarily quite stiff torsionally, as well as laterally, in that they must be well gusseted to adjacent frames and, forming the edge of the plate panels, must be stiff enough to prevent lateral deflections. Hence, the analytical treatment under both limiting conditions of edge support should give considerable guidance in design.

The ratio of frame spacing to stringer spacing ordinarily exceeds 3.0 and hence, the aspect ratio of the plating panels for use in design can usually be taken as infinite.

3.53. **BOTTOM STRINGERS.** As previously mentioned, the bottom stringers serve to transfer the bottom plating normal loads to the transverse frames. They may be considered in general as continuous beams supported at the frames with a running load per unit of length equal to the stringer spacing times the intensity of bottom pressure. Under the ordinary conditions of uniform pressure, frame and stringer spacings, the symmetry of loading would permit the consideration of the stringer as a uniformly loaded continuous beam over fixed supports. This would lead to a design bending moment in the stringer:

$$M = \frac{wL^2}{12} \quad (3:61)$$

where W = stringer transverse loading, in pounds per inch

and L = support spacing, in inches.

The extreme probability of loadings other than symmetrical and the finitely elastic nature of the support restraint leads to the use of the more conservative specification of the design bending moment as:

$$M = \frac{wL^2}{10} \quad (3:62)$$

When the conditions of loading are definitely different from these assumptions (that is, when the pressure varies, when the stringer is not continuous, or when the support has unusual restraint characteristics) the stringer should of course, be designed to the local conditions specifically applicable.

It is rational to consider a portion of the plating adjacent to a stringer as effectively contributing to the section properties of the stringer. It is important that the same assumptions as to plating effectiveness be used in converting test data into allowable stresses as is used in the analysis of the flight article under the specified loads.

As well as being analyzed for the specified design bottom-pressure loading, the plating and stringer combination should be checked for the conditions in which it is both subjected to direct water loads and also forms a part of the effective flange material of the general longitudinal girder structure. In such conditions, the stresses resulting from the bottom pressures consistent with the loading on the general structure are superimposed upon the stresses incurred as a portion of the flanges of the general structure.

3.54. **FRAMES.** Hull and float frame design differs from ordinary fuselage frame design principally in the nature of the applied loads which result from direct water pressures. Each frame is considered to take the bottom loadings applied to the plating and stringer combination structure in the area adjacent to the frame. Such loaded area extends approximately one-half of the frame spacing to both sides. The bottom loads are usually transmitted from the stringers directly to the frame in the area between the chines. The assumptions as to the nature and magnitude of the balancing reactions in the form of shear in the side and deck plating may be patterned after those used in fuselage frame design.

In almost all instances, frame analysis involves the problem of the application of the fundamental methods of least work and in this respect may be treated in a manner similar to that employed with

analogous fuselage frames. The probability of unsymmetrical loading applications on V-bottom hulls and floats in take-off and landing is quite high. For this reason the procuring or certifying agency specifies in all instances certain unsymmetrical design-loading conditions. Such loading conditions are often critical for the design of frames, and hence the analysis of frames loaded in this manner should be given the utmost care and consideration.

3.55. **STRENGTH DETERMINATION.** The strength of the structure is determined by comparison of the calculated internal loads and stresses with the allowables obtained either from tests or from the information given in chapter 2. The determination of the strength of shell structures, including reinforced shells, is presented in detail in section 3.138.

3.6. Miscellaneous

Treatment of the wing, fuselage, hull, tail, and control surfaces does not complete the stress analysis of the airplane structure. In airplanes of wood construction, however, it is considered that these same structural components constitute nearly all of those in which the use of wood is sig-

nificant and in the analysis of which the physical properties of wood will enter as an important factor. Hence, for such reasons and as explained in section 3.00, treatment of the detailed analysis problems related to the remaining important airplane structural components will not be included herein. Such components would include, for example, landing gear, engine mount, control systems, fittings, and joints. The determination of the design load applied to each individual wood structural element of a joint (mechanical joint or glue joint), or fitting attachment, may be determined by basic principles of mechanics and machine design. Where it would significantly affect the distribution of the design load, the nonisotropic nature of wood, which results in the strength and elastic characteristics being dependent upon the relation between the directions of the load and of the grain, should be taken into account by a rational treatment or provided for by conservative arbitrary assumptions. The design load thus determined for such an element should be compared with the allowable load defined by the applicable portions of chapter 2 (principally section 2.9). The designer is referred, in general, to the many existing tests, technical papers, and publications which adequately handle such miscellaneous analysis problems.

REFERENCES FOR CHAPTER 3

- (3-1) AKERMAN, J. D. AND STEPHENS, B. C.
1938. *Polar Diagrams for Solution of Axially Loaded Beams*. Jour. Aero. Sci. July, 1938.
- (3-2) CROSS, HARDY
1930. *The Column Analogy*. Univ. of Illinois Eng. Exp. Sta. Bulletin 215.
- (3-3) _____
1930. *Analysis of Continuous Frames by Distributing Fixed-End Moments*. Proc. A.S.C.E. May, 1930.
- (3-4) ERLANDSEN, O. AND MEAD, L.
1942. *A Method of Shear-Lag Analysis of Box Beams for Axial Stresses, Shear Stresses, and Shear Center*. N.A.C.A. Advance Restricted Report.
- (3-5) HATCHER, ROBERT S.
1937. *Rational Shear Analysis of Box Girders*. Jour. Aero. Sci. April, 1937.
- (3-6) EBNER, HANS
1934. *Torsional Stresses in Box Beams With Cross Sections Partially Restrained Against Warping*. N.A.C.A. Tech. Memo. 744.
- (3-7) KUHN, PAUL
1935. *Analysis of Two-Spar Cantilever Wings With Special Reference to Torsion and Load Transference*. N.A.C.A. Tech. Rept. 508.
- (3-8) _____
1935. *Bending Stresses Due to Torsion in Cantilever Box Beams*. N.A.C.A. Tech. Note 530.
- (3-9) _____
1938. *Approximate Stress Analysis of Multi-Stringer Beams With Shear Deformation of the Flanges*. N.A.C.A. Tech. Rept. 636.
- (3-10) KUHN, PAUL
1939. *Loads Imposed on Intermediate Frames of Stiffened Shells*. N.A.C.A. Tech. Note 687.
- (3-11) _____
1939. *Some Elementary Principles of Shell Stress Analysis With Notes on the Use of the Shear Center*. N.A.C.A. Tech. Note 691.
- (3-12) _____
1942. *A Method of Calculating Bending Stresses Due to Torsion*. N.A.C.A. Advanced Technical Report. (Restricted)
- (3-13) KUHN, P. AND CHAIRITO, P.
1941. *Lag in Box Beams, Methods of Analysis and Experimental Investigations*. N.A.C.A. Tech. Note 739. (Restricted)
- (3-14) LUNDQUIST, E. AND SCHWARTZ, E. B.
1942. *A Study of General Instability of Box Beams With Truss Type Ribs*. N.A.C.A. Tech. Note 866. (Restricted)
- (3-15) NILES, A. S. AND NEWELL, J. S.
1938. *Airplane Structures*. Second edition John Wiley and Sons, Inc.
- (3-16) ROWE, C. J.
1924. *Application of the Method of Least Work to Redundant Structures*. A.C.I.C. 495.
- (3-17) SCHWARTZ, A. M. AND BOGERT, R.
1935. *Analysis of a Strut With a Single Elastic Support in the Span, With Applications to the Design of Airplane Jury-Strut Systems*. N.A.C.A. Tech. Note 529.
- (3-18) SHANLEY, F. R. AND COZZONE, F. P.
1941. *Unit Method of Beam Analysis*. Jour. Aero. Sci. April, 1941.
- (3-19) WAGNER, H.
1937. *The Stress Distribution in Shell Bodies and Wings as an Equilibrium Problem*. N.A.C.A. Tech. Memo. 817.

CHAPTER 4

DETAIL STRUCTURAL DESIGN

4.0. General

4.00. INTRODUCTION. Detail design practice is constantly changing and current good practice may at any time be obsoleted by some new treatment of a particular design problem. Therefore, the examples presented on the following pages represent only the current methods used in handling problems of design details. It should be remembered, however, that many of these methods have withstood the test of time, having been used since the first introduction of wood aircraft.

4.01. *Definitions.* The following definitions explain a few general terms which are sometimes confused by the wood aircraft designer. Other terms requiring definition are explained as they appear in the text.

4.010. *Solid wood.* Solid wood or the adjective "solid" used with such nouns as beam or spar refers to a member consisting of *one piece* of wood.

4.011. *Laminated wood.* Laminated wood is an assembly of two or more layers of wood which have been glued together with the grain of all layers or laminations approximately parallel.

4.012. *Plywood.* Plywood is an assembled product of wood and glue that is usually made of an odd number of thin plies (veneers) with the grain of each layer at an angle of 90° with the adjacent ply or plies.

4.013. *High-density material.* The term "high density material" as used throughout this chapter includes compreg or similar commercial products, heat stabilized wood, or any of the hardwood plywoods commonly used as bearing or reinforcement plates.

4.1 Plywood Covering

4.10. GENERAL. Nearly all wood aircraft structures are covered with stressed plywood skin. The notable exceptions are control surfaces and the rear portion of lightly loaded wings. Shear

stresses are almost always resisted by plywood skin, and in many cases, a portion of the bending and normal loads is also resisted by the plywood.

4.11. JOINTS IN THE COVERING. Lap, butt, and scarf joints are used for plywood skin.

When plywood joints are made over relatively large wood members, such as beam flanges, it is desirable to use splice plates, often called aprons or apron strips, regardless of the type of joint. It is desirable to extend the splice plates beyond the edges of the flange so that the stress in the skin will be lowered gradually, thus reducing the effect of the stress concentration at this point. Splice plates (fig. 4-1) can be made to do double duty if they are scalloped corresponding to rib locations so that they may act as gussets for the attachment of the ribs.

Scarf joints are the most satisfactory type and should be used whenever possible. Scarf splices in plywood sheets should be made with a scarf slope not steeper than 1 in 12 (fig. 4-2). Some manufacturers prefer to make scarf joints in such a way that the external feather edge of the scarf faces aft in order to avoid any possibility of the airflow opening the joint.

If butt joints (fig. 4-3) are made directly over solid or laminated wood members, as over a spar or spar flange, experience has indicated that there is a tendency to cause splitting of the spar or spar flange at the butt joint under relatively low stresses. A similar tendency toward cleavage exists where a plywood skin terminates over the middle of a wood member instead of at its far edge.

Lap joints (fig. 4-4) are not recommended because of the eccentric load placed upon the glue line. If this type is used it should be made parallel to the direction of airflow, only, for obvious aerodynamic reasons.

4.12. TAPER IN THICKNESS OF THE COVERING. Loads in the plywood covering usually vary from section to section. When this is so, structural

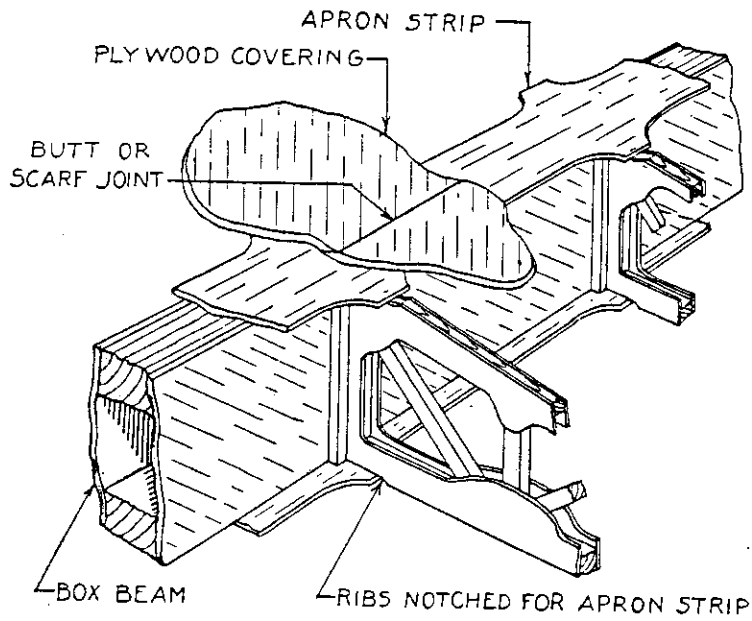

Figure 4-1. Use of splice plate or apron strip.

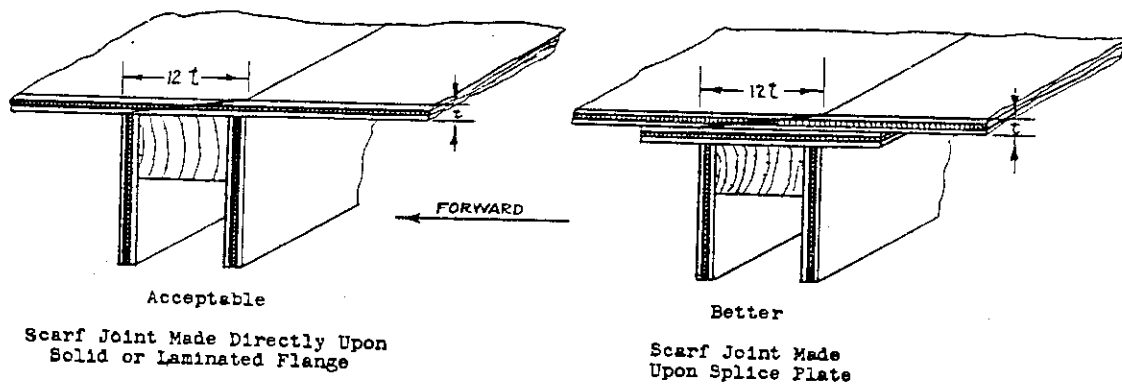

Figure 4-2. Scarf splices.

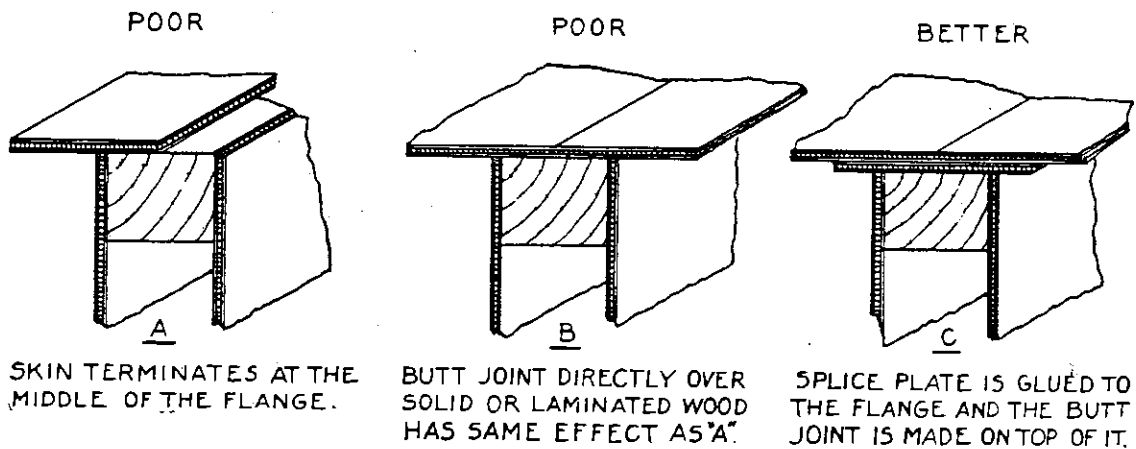

Figure 4-3. Butt splices.

efficiency may be increased by tapering the plywood skin in thickness so that the strength varies with the load as closely as possible (fig. 4-5). To taper plywood in thickness plies should be added as dictated by increasing loads. In doing so, the plywood should always remain symmetrical. For example, plywood constructed of an odd number

of plies of equal thickness can be tapered, and at the same time maintain its symmetry, by adding two plies at a time. This method is suitable for bag molding construction. Stress concentrations should be avoided by making the change in thickness gradual, either by feathering or by scalloping. In bag molding construction, the additional plies

are often added internally so that the face and back are continuous.

When flat plywood is used, the usual method of tapering skin thickness is to splice two standard plywood sheets of different thicknesses at an appropriate rib station with a slope of scarf not steeper than 1 in 12 as shown in figure 4-6.

4.13. BEHAVIOR UNDER TENSION LOADS. Because the proportional limit in tension and the ultimate tensile strength of wood are reached at approximately the same time, plywood skin loaded in tension must be designed very carefully. Observation of various static test articles has indicated that square-laid plywood (plywood laid so that face grain is parallel or perpendicular to the direction of the principal bending stresses) has a tendency to rupture in tension before the ultimate strength of the structure has been reached (fig. 4-7). Diagonal plywood, however, seldom ruptures before some other structural member fails. The reason for this behavior is probably due partly to the fact that none of the fibers of the

diagonal plywood are in pure tension. The failure under tension load at 45° to the grain is almost entirely a shear failure, and the fibers, which have a definite yield beyond the proportional limit in shear, may undergo enough internal adjustment to permit the plywood to deflect with the structure until some other member becomes critically loaded. Square-laid plywood does not yield because some of its plies will fail in tension almost immediately after the proportional limit has been reached. This drawback of square-laid plywood becomes less important when the skin is designed to carry a greater proportion of the bending loads. For the limiting case of a shell structure without flanges, square-laid plywood is preferable.

Rupture of the skin is also influenced by its relative distance from the neutral axis. If the beam or beams are located so that part of the skin is appreciably farther from the neutral axis than the beam flanges, the skin is more likely to have a premature failure than if the flanges are located at the greatest outer fiber distance. Such a con-

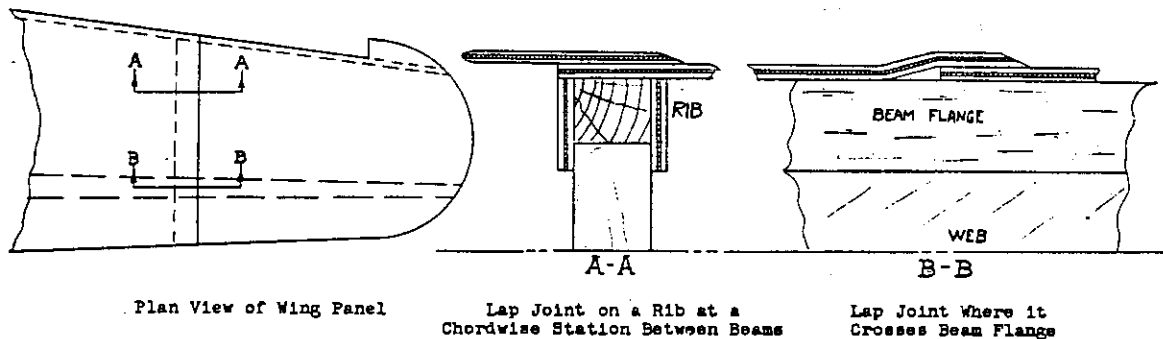

Figure 4-4. Lap splices.

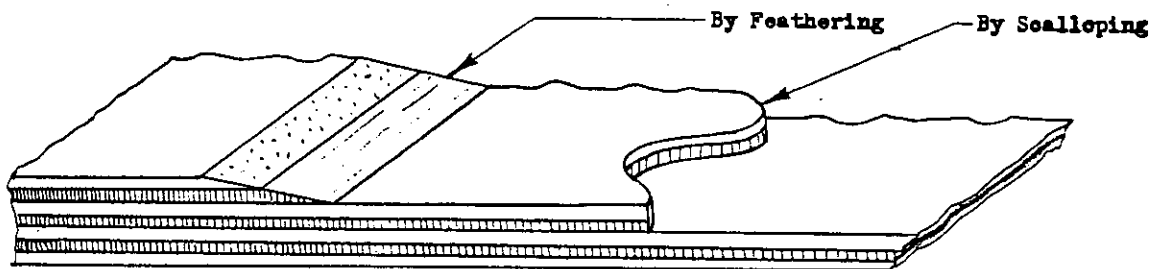

Figure 4-5. Tapering plywood in thickness

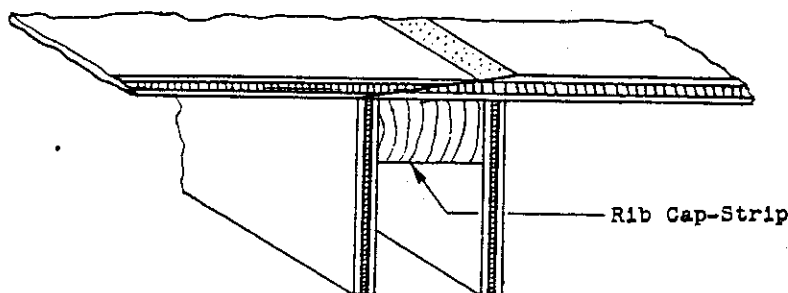

Figure 4-6. Scarfing plywood of different thicknesses.

dition is illustrated by wing spars placed at the 15 and 65 percent chordwise stations of a normal airfoil.

Where the spanwise plies of plywood covering are of a wood species different from the beam flanges, it is, of course, desirable that such plies have a ratio of ultimate tensile stress to modulus of elasticity equal to or greater than that of the beam flanges.

4.14. BEHAVIOR UNDER SHEAR LOADS. Diagonal plywood (face grain at 45° angle to the edge of the panel) is approximately five times stiffer in shear than square-laid plywood and somewhat stronger. When shear strength or stiffness is the

controlling design consideration, diagonal plywood should be used (sec. 4.22).

4.15. PLYWOOD PANEL SIZE. In certain cases the size of plywood panels is dictated by the magnitude of directly computable stresses. These occur, for example, in spar webs, D-tube nose skin, and fuselage side panels subjected to high shear. In many other cases, however, the design loads are insignificant. It then becomes necessary to choose combinations of skin thickness and panel size which will stand up under expected handling loads, have acceptable appearance, and aerodynamic smoothness. The typical values given in table 4-1 have been employed by experienced manufacturers.

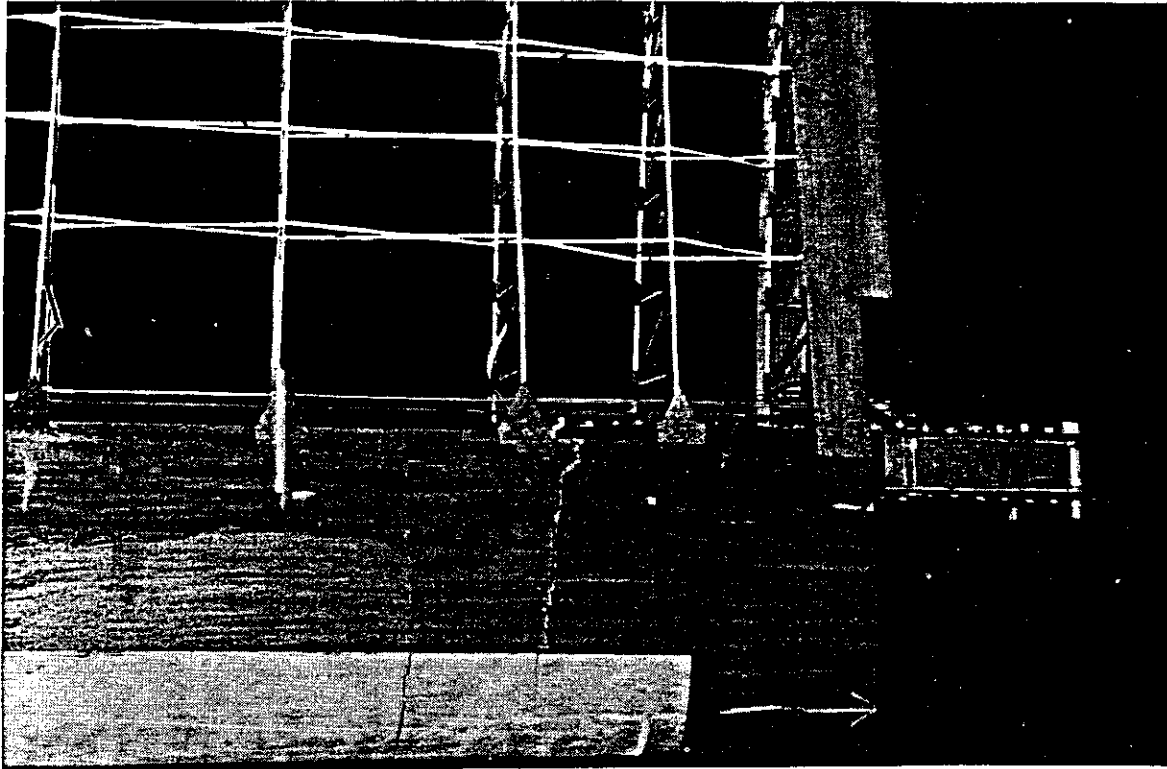

Figure 4-7. Static test wing showing tension failure of plywood covering.

Table 4-1. Typical panel sizes

Material	Thickness	Panel size	Location	Remarks
Mahogany, yellow poplar core	<i>Inch</i> 1/16-3/32	<i>Inch</i> 12 by 24 maximum	Wing skin.	Spanwise face grain.
Do	1/16	9 1/2 by 10 1/2	do	
Do	1/16	10 by 12	do	
Do	1/16	5 by 9	Leading edge skin.	
Do	1/16	11 by 20	Vertical fin.	
Do	1/16	10 by 11	Stabilizer.	
Do	1/8	24 or 36 square	Fuselage	
Mahogany	1/16	7 by 14	Leading edge skin	Spanwise face grain.
Do	1/16	18 by 24	Fuselage	Just aft of cabin.
Yellowpoplar	3/32	14 by 36	Wing aft of 50 percent chord.	

4.16. CUT-OUTS. When cut-outs are made in plywood skin for windows, inspection holes, doors, or other purposes, sharp corners should be avoided, and for all but small holes in low-stressed skin, a doubler should be glued to the skin around the cut-out. For some types of cut-outs a framework can be installed to carry the shear load and doublers need not be used (figs. 4-8, 4-9, and 4-10).

4.2. Beams

4.20. TYPES OF BEAMS. The types of beams shown in figure 4-11 have been used frequently as wing spars, control surface spars, floor beams and wing ribs. The terms "beam" and "spar" are often used interchangeably and both are used in this chapter.

The wood-plywood beams (box-, I-, double I-, and C-) are generally more efficient load-carrying members than the plain wood types (plain rectangular and routed). A discussion of the relative

merits of these various beam types is presented in succeeding paragraphs.

The box beam is often preferred because of its flush faces which allow easy attachment of ribs (sec. 4.32). The interior of box beams must be finished, drained, and ventilated. Inspection of interiors is usually difficult. The shear load in a box beam is carried by two plywood webs. By checking shear web allowables by the method given in section 2.73, it will be seen that for the same panel size a plywood shear panel half the thickness of another will carry less than half the shear load which can be carried by the thicker panel.

The preceding statement points to an outstanding advantage of the I-beam since its shear strength is furnished by a single shear web rather than the two webs required of a box or double I-beams. Also, the I-beam produces a more efficient connection between the web and flange material than the box beam in cases where the web becomes buckled before the ultimate load is

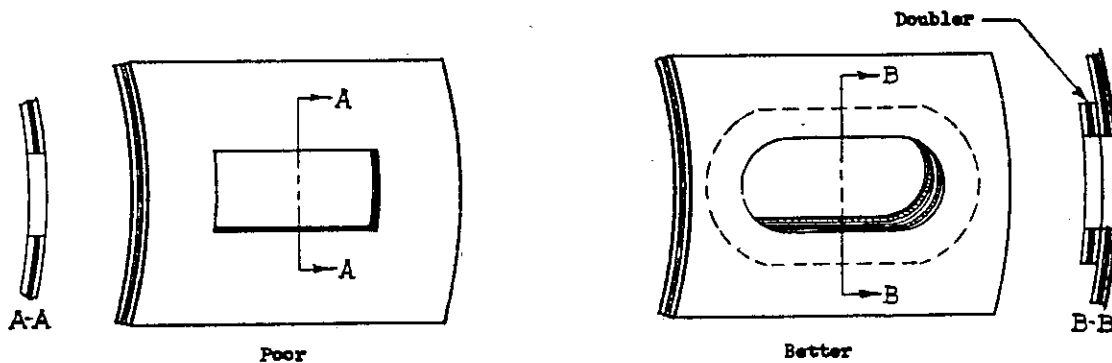

Figure 4-8. Plywood cut-outs.

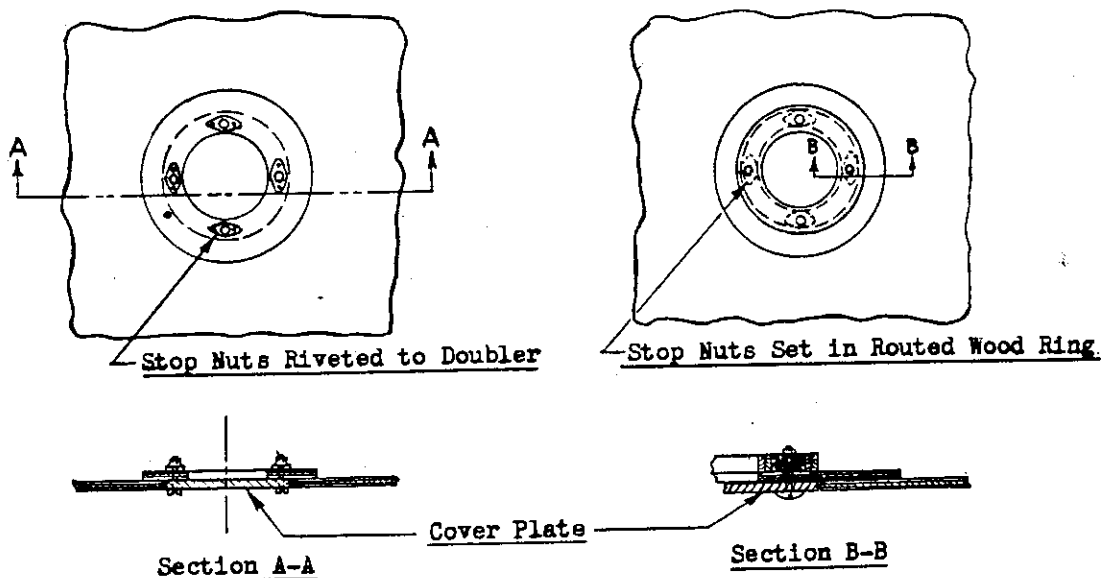

Figure 4-9. Two methods of attaching inspection hole covers.

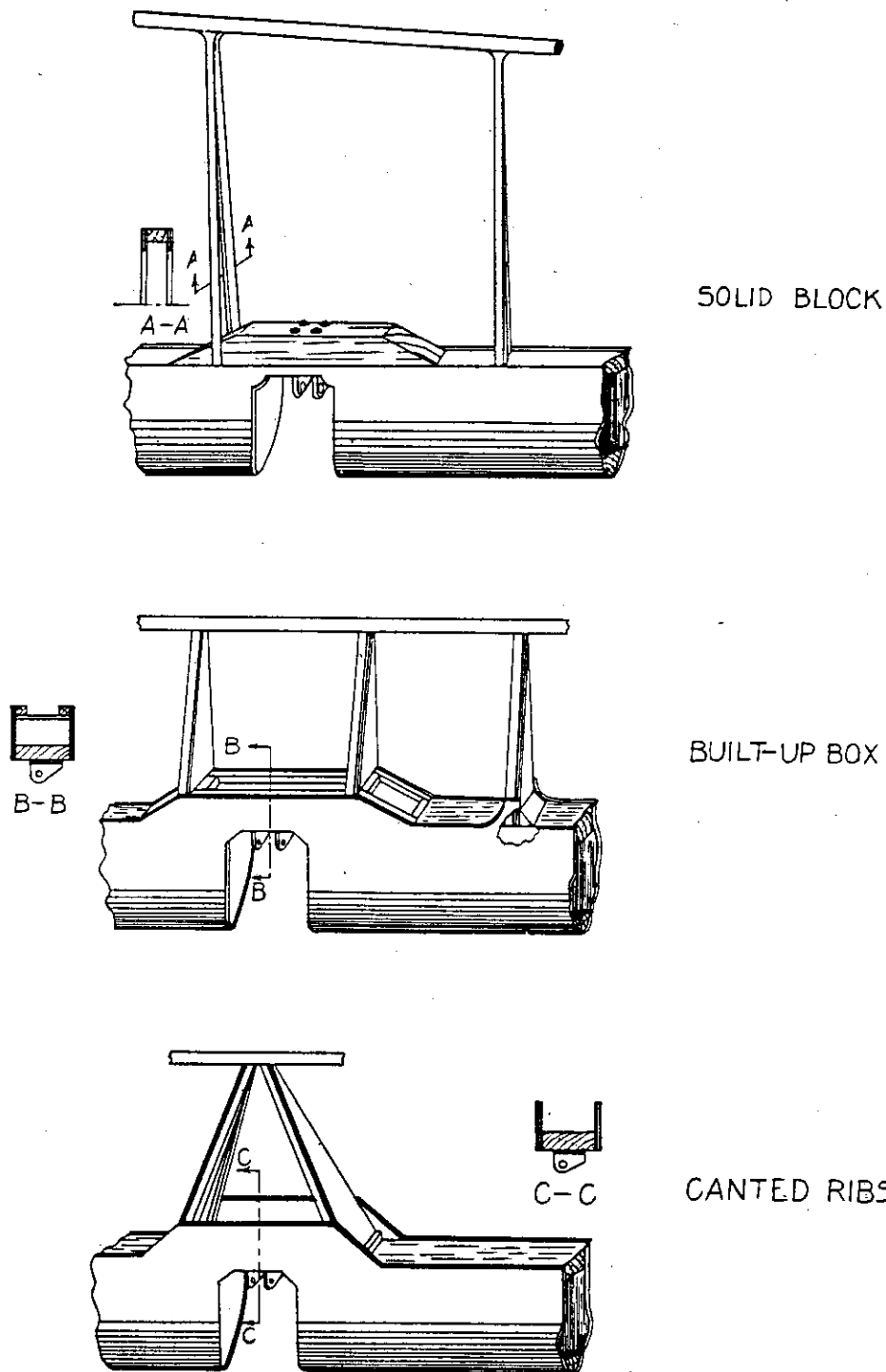

Figure 4-10. Methods of carrying torsion loads around hinge cut-outs in control surfaces.

reached. This is because the clamping action on the webs tends to reduce the possibility of the tension component of the buckled web cleaving it away from the flange.

The double I-beam is usually a box beam with external flanges added along that portion where the bending moments are greatest. This type allows a given flange area to be concentrated farther from the neutral axis than other types.

The C-beam affords one flush face for the flush

type of rib attachment but it is unstable under shear loading. C-beams are generally used only as auxiliary wing spars or control surface spars.

Plain rectangular beams are generally used where the saving in weight of the wood-plywood types is not great enough to justify the accompanying increase in manufacturing trouble and cost. This is usually the case for small wing beams, control-surface beams, and beams that would require a great deal of blocking.

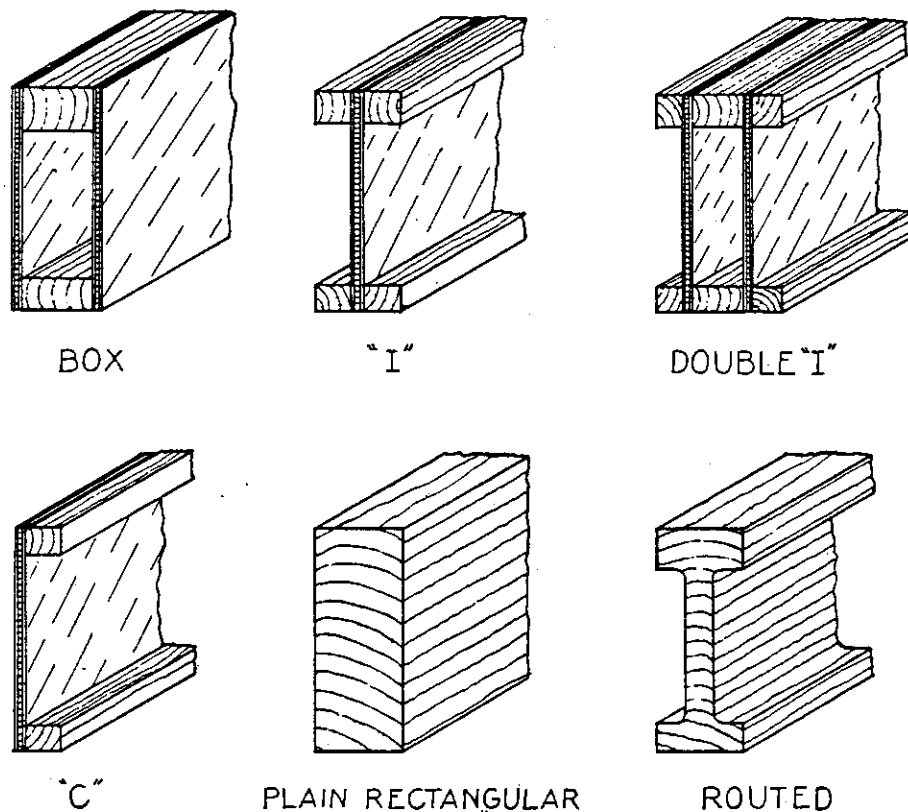

Figure 4-11. Types of beams.

Routed beams are somewhat lighter than the plain rectangular type for the same strength but not so light as wood-plywood types. Usually this small weight saving does not justify the increase in fabrication effort and cost.

In determining the relative efficiency of any beam type, reduction in allowable modulus of rupture due to form factors must be considered.

4.21. LAMINATING OF BEAMS AND BEAM FLANGES. Beam flanges and plain rectangular and routed beams can be either solid or laminated. A detailed discussion of methods of laminating beams and beam flanges is presented in section 2.4 of ANC Bulletin 19, Wood Aircraft Inspection and Fabrication (ref. 2-24).

Since the tension strength of a wood member is

more adversely affected by any type of defect than is any other strength property, it is recommended that all tension flanges be laminated in order to minimize the effect of small defects and to avoid the possibility of objectionable defects remaining hidden within a solid member of large cross section.

4.22. SHEAR WEBS. Although square-laid plywood has been used extensively as shear webs in the past, the present trend is to use diagonal plywood (fig. 4-12) because it is the more efficient shear carrying material (sec. 4.14).

It is desirable to lay all diagonal plywood of an odd number of plies so that the face grain is at right angles to the direction of possible shear buckles. In this way the shear web will carry

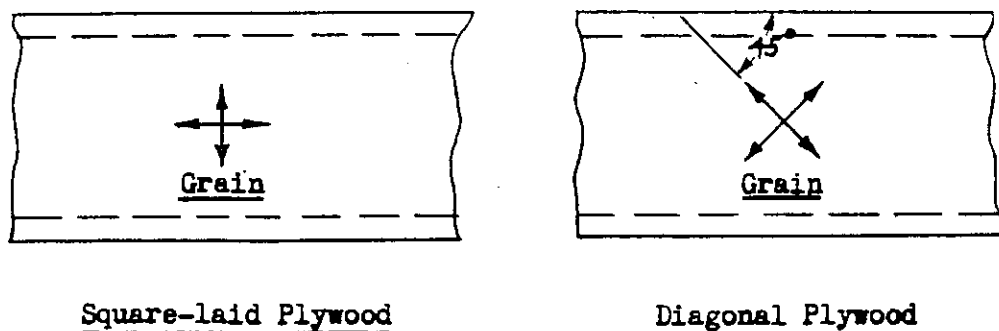

Figure 4-12. Types of shear webs.

appreciably higher buckling and ultimate loads because plywood is much stiffer in bending in the direction of the face grain and offers greater resistance to buckling if laid with the face grain across the buckles (fig. 4-13). This effect is greatest for 3-ply material.

Figure 4-14 illustrates various methods of splicing shear webs. If the splices are not made

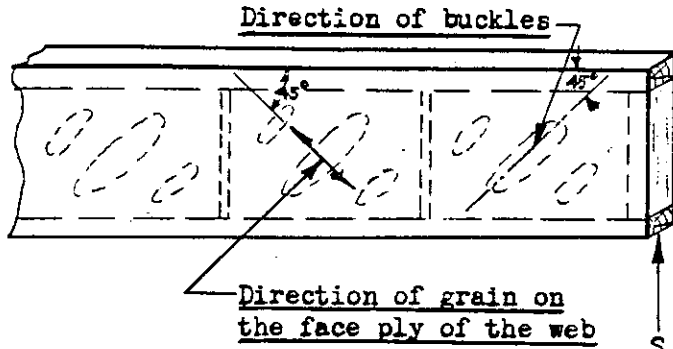

Figure 4-13. Orientation of face grain direction of diagonal plywood shear webs.

prior to the assembly of the web to the beam, blocking must be inserted at the splice locations to provide adequate backing for the pressure required to obtain a satisfactory glue joint.

4.23. BEAM STIFFENERS. Shear webs should be reinforced by stiffeners at frequent intervals as the shear strength of the web depends partly upon stiffener spacing (fig. 4-15). In addition to their function of stiffening the shear webs, the ability of beam stiffeners to act as flange spreaders is very important and care must be exercised to provide a snug fit between the ends of the stiffeners and the beam flanges. External stiffeners for box beams are inefficient because of their inability to act as flange spreaders.

Stiffeners are usually placed at every rib location so that the web will be stiffened sufficiently to resist rib-assembly pressures.

4.24. BLOCKING. Any blocking, introduced for the purpose of carrying fitting loads (fig. 4-16),

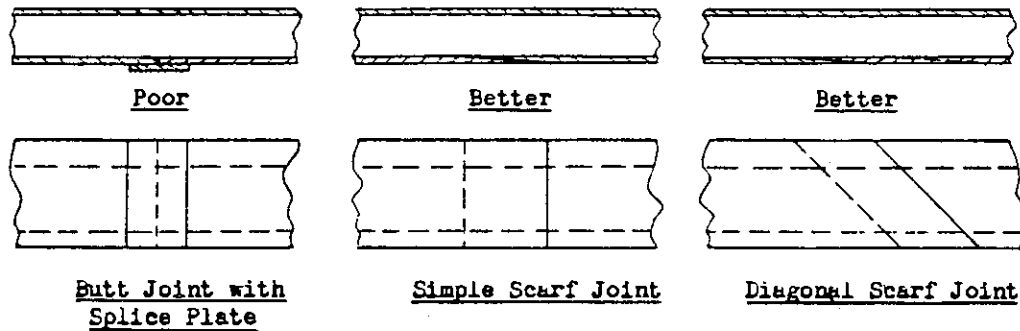

Figure 4-14. Methods of splicing shear webs.

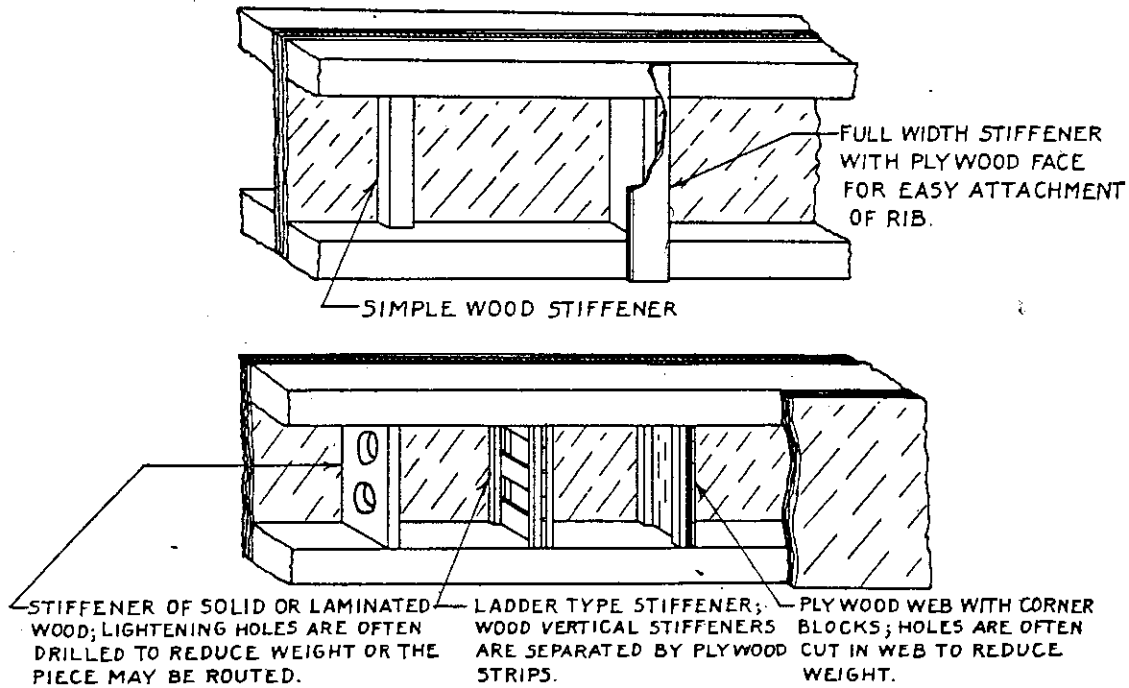

Figure 4-15. Typical stiffeners for I- and box-beams.

should be tapered as much as possible to avoid stress concentrations. It is desirable to include a few cross-banded laminations in all blocking in order to reduce the possibility of checking.

4.25. SCARF-JOINTS IN BEAMS. The following requirements should be observed in specifying scarf joints in solid or laminated beams and beam flanges:

1. The slope of all scarfs should be not steeper than 1 in 15. The proportion of end grain appearing on a scarfed surface is undesirably increased if the material to be spliced is somewhat cross-grained, and the scarf is made "across" rather than in the general direction of the grain (fig. 4-17). For this reason it is very desirable that the following note be added to all beam drawings showing scarf joints:

Note. Where cross grain within the specified acceptable limits is present, all scarf cuts should be made in the general direction of the grain slope.

2. In laminated members the longitudinal distance between the nearest scarf tips in adjacent laminations shall be not less than 10 times the thickness of the thicker lamination (fig. 4-18).

In addition to the previously mentioned specific requirements, it is recommended that the number of scarf joints be limited as much as possible; the location be limited to the particular portion of a member where margins of safety are most adequate and stress concentrations are not serious;

and special care be exercised to employ good technique in all the preparatory gluing, and pressing operations.

4.26. REINFORCEMENT OF SLOPING GRAIN. Where necessary tapering produces an angle between the grain and edge of the piece greater than the allowable slope for the particular species, the piece should be reinforced to prevent splitting by gluing plywood reinforcing plates to the faces (fig. 4-19).

4.3. Ribs

4.30. TYPES OF RIBS. Rib design has changed very little for several years. See N. A. C. A. Technical Report 345 (ref. 2-64). The more common types are the plywood web, the lightened plywood web, and the truss. The truss type is undoubtedly the most efficient, but lacks the simplicity of the other types.

For fabric-covered wings the ribs are usually one piece with the cap strips continuous across the spars. When plywood covering is used the ribs are usually constructed in separate sections (fig. 4-20).

Continuous gusset stiffen cap strips in the plane of the rib. This aids in preventing buckling and helps obtain better rib-skin glue joints where nail gluing is used because such a rib can resist the driving force of nails better than other types. Continuous gussets (fig. 4-21) are more easily handled than the many small separate gussets otherwise required.

Any type of rib may be canted to increase the

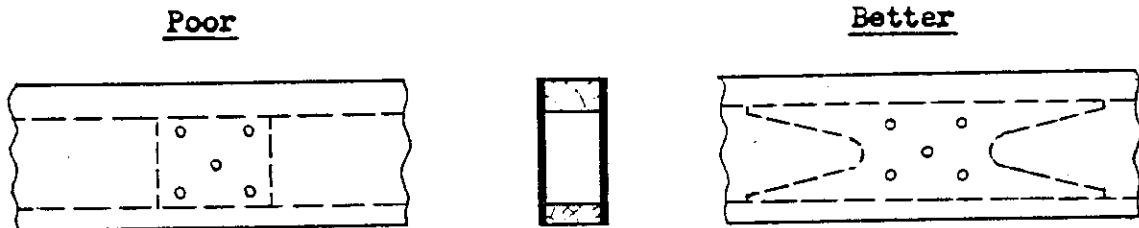

Figure 4-16. Bearing blocks in box spar.

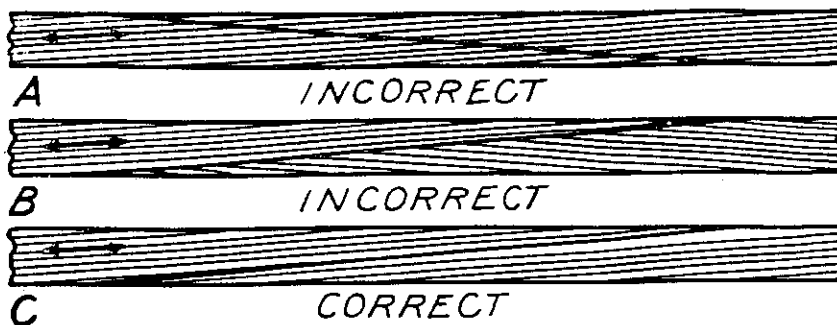

Figure 4-17. Relationship between grain slope and scarf slope.

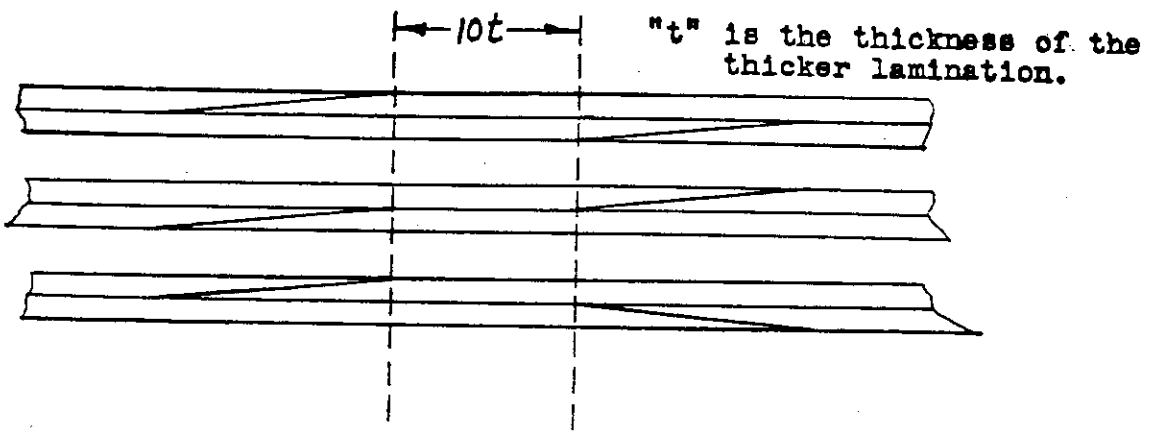

Figure 4-18. Minimum permissible longitudinal separation of scarf joints in adjacent laminations.

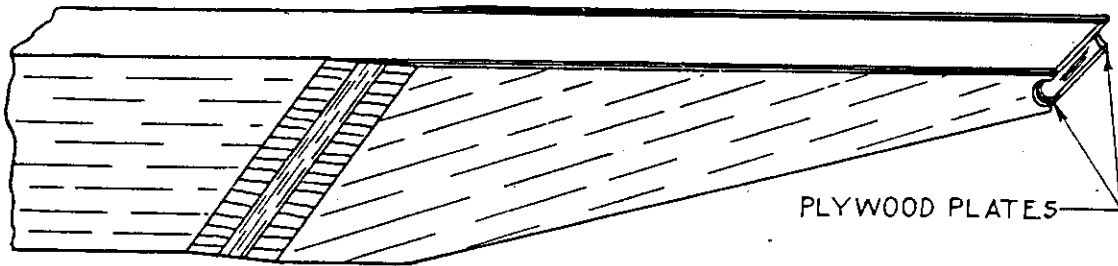
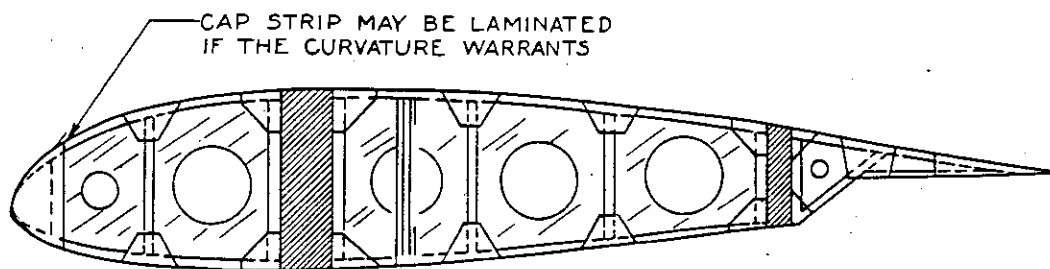
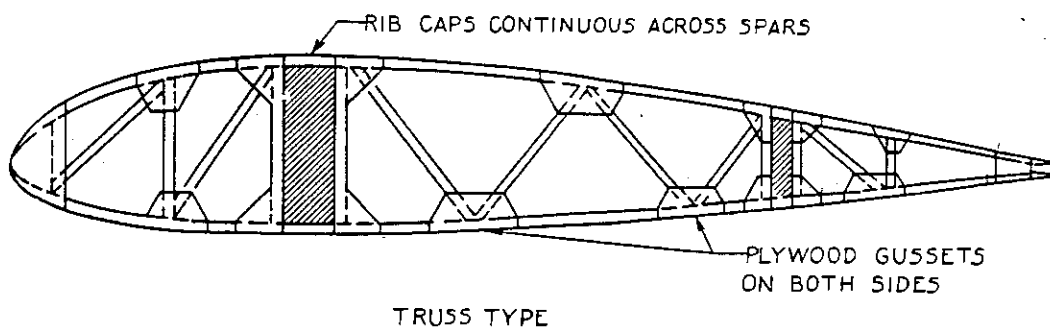

Figure 4-19. Solid wing spar at tip.



LIGHTENED PLYWOOD WEB TYPE

Figure 4-20. Typical wing ribs.

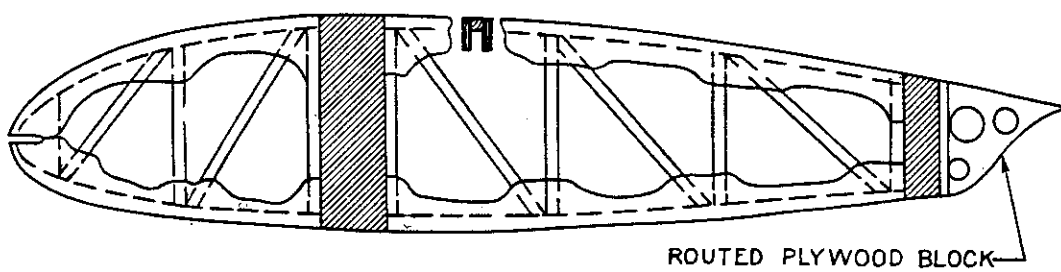

Figure 4-21. Rib employing continuous gussets.

torsional rigidity of a structure such as a wood-framework, fabric-covered control surface (fig. 4-22).

Diagonals loaded in compression are more satisfactory than diagonals loaded in tension since tension diagonals are more difficult to hold at the joints.

4.31. SPECIAL PURPOSE RIBS. Where concentrated loads are introduced, as at landing gear or nacelle attachments, bulkhead-type ribs can be used to advantage. When this is the case, the rib acts as a chordwise beam, and the principles presented in section 4.2 will apply (fig. 4-23).

4.32. ATTACHMENT OF RIBS TO THE STRUCTURE. In general, ribs are glued to the adjacent structure

by means of corner blocks, plywood angles or gussets, or in special cases, by some mechanical means. These are all shown in detail in figures 4-24, 4-25, 4-26, 4-27, 4-34, and 4-39.

Although the attachment of ribs to I-beams may complicate the rib design, many engineers believe that the mechanical shear connection obtained by notching the ribs so that the end may be inserted between the I-beam flanges is an advantage since the shear connection is not dependent upon quality of the glue joint between the rib and the beam shear web. This type of connection is shown in figure 4-25. The web vertical also acts as a stiffener for the beam shear web and as a flange spreader.

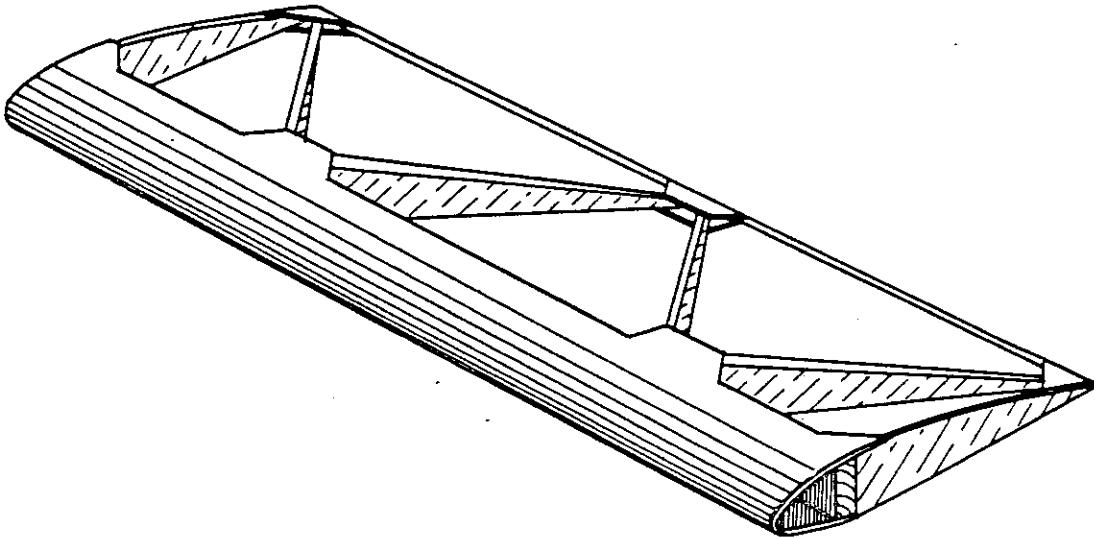

Figure 4-22. Control surface employing canted ribs.

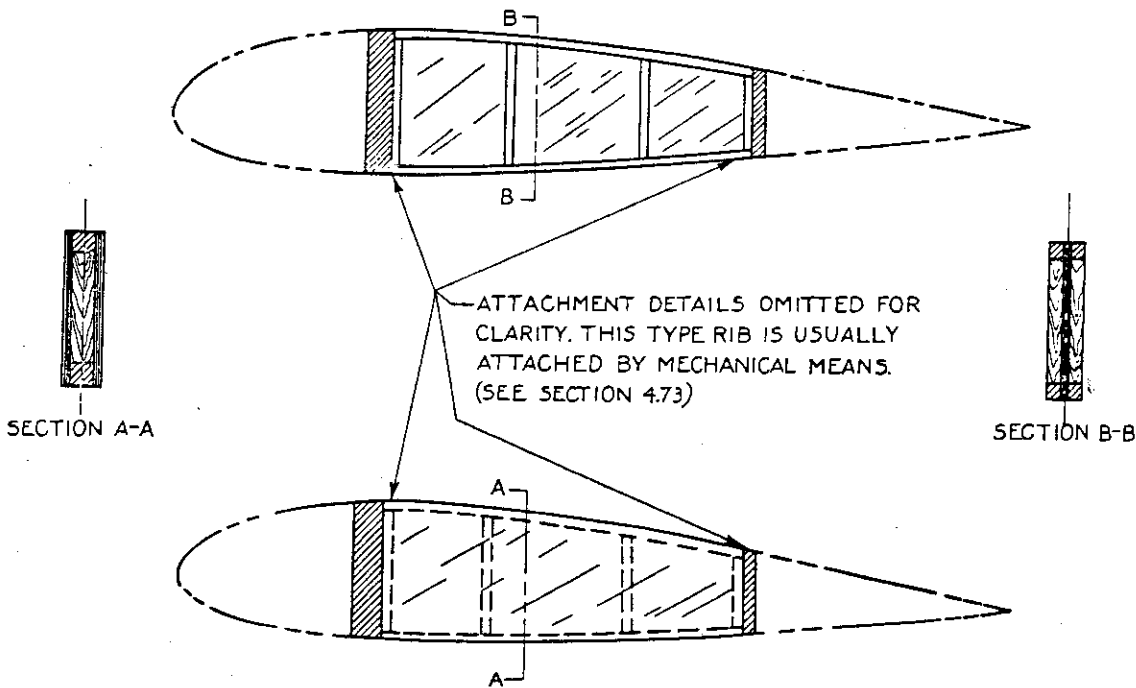

Figure 4-23. Special purpose ribs.

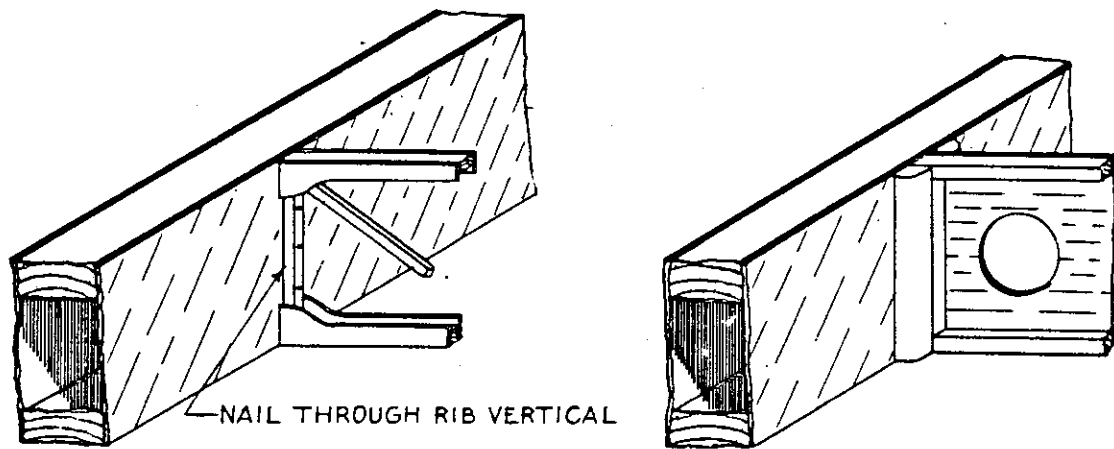

Figure 4-24. Typical rib attachments to flush surface beams.

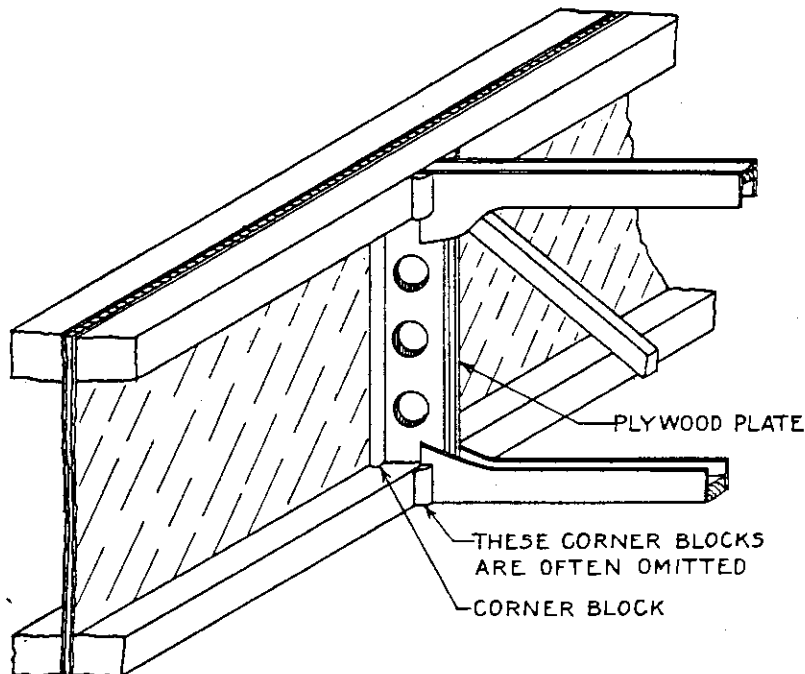

Figure 4-25. Typical rib attachment to I-beam.

The end rib verticals of plywood web type ribs are sometimes preassembled to plain rectangular spars to act as locating members for rib-to-spar assembly. This is shown in figure 4-26. Pre-assembled locating corner blocks might also be used to advantage in other types of rib-to-spar attachments if care is taken to provide sufficient backing for plywood webs to which corner blocks are being glued so that sufficient gluing pressure can be obtained.

Canted ribs may be attached to beam members by beveling the ends of the ribs or by using corner blocks as shown in figure 4-27.

4.4. Frames and Bulkheads

4.40. TYPES OF FRAMES AND BULKHEADS. No one type of frame or bulkhead seems to be the

best for all types of loading, but the laminated ring is probably the best type for use as an intermediate stiffening frame. Frames or bulkheads are usually made of formed laminated wood, cut or routed from plywood, or are a combination of the two (fig. 4-28).

4.41. GLUE AREA FOR ATTACHMENT OF PLYWOOD COVERING. Care must be taken when using the routed plywood type of bulkhead that the plywood edge provides sufficient gluing area for the skin. It is often necessary to glue solid wood to the face of the ring near its edge to provide additional gluing surface. This is illustrated in figure 4-29.

4.42. REINFORCEMENTS FOR CONCENTRATED LOADS. When concentrated loads are carried into a frame it may be desirable to scarf in some

CORNER BLOCK EXERTS
PRESSURE AGAINST BOTH
THE BEAM AND THE RIB
VERTICAL MEMBER

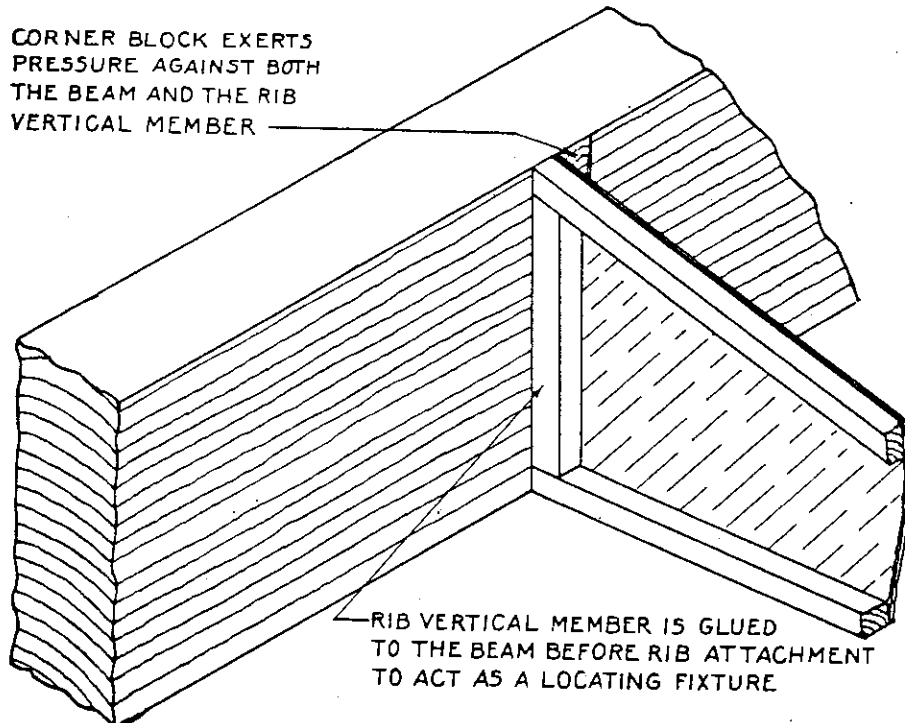

Figure 4-26. Use of rib vertical as locating fixture.

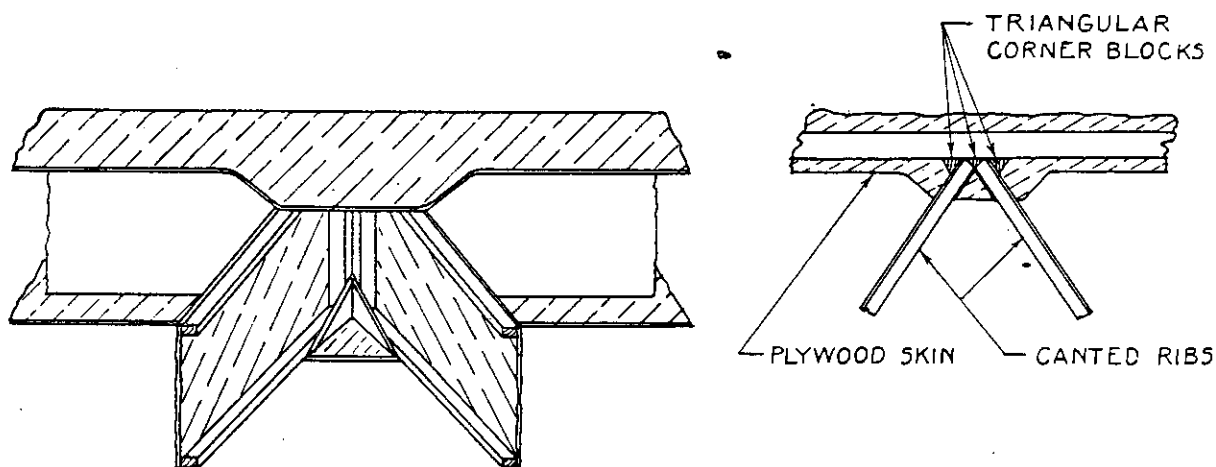

Figure 4-27. Typical canted rib to spar attachment.

high-density material and brace the frame with a plywood web or solid truss members.

4.5. Stiffeners

4.50. GENERAL. The terms "stringer," "stiffener," and "intercostal" are often used interchangeably. In the following discussion, "stringer" will refer to members continuous through ribs and frames and "intercostal" will refer to members terminating at each rib or frame. The term "stiffener" will not be used, since both stringers and intercostals act as stiffeners.

4.5.1. ATTACHMENT OF STRINGERS. Ribs or frames must be notched if stringers are used. A

method of reinforcing these notches and fastening the stringers to the rib or frame is illustrated in figure 4-30. Attachments may also be made by one of the methods shown in figure 4-34.

4.5.2. ATTACHMENT OF INTERCOSTALS. All intercostals should be firmly attached to ribs or frames. Figure 4-31 illustrates the undesirable practice of terminating intercostals some distance from the rib or frame. This usually results in cleavage along the glue line starting at the free end of the intercostal. It is better to butt the stiffeners to the rib or frame and fasten them with saddle gussets as illustrated in figure 4-32 or by one of the attachments shown in figure 4-34.

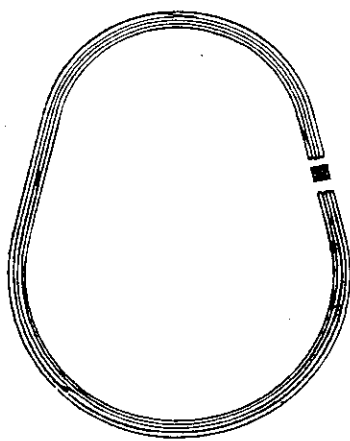

Laminated Ring

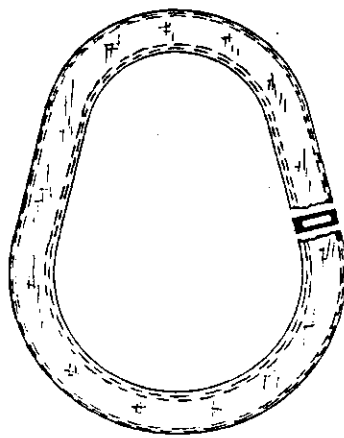

Box Bulkhead of Laminated Rings and Thin Plywood

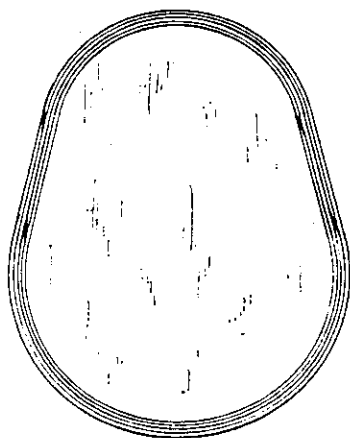

Laminated Ring with Thin Plywood Bulkhead

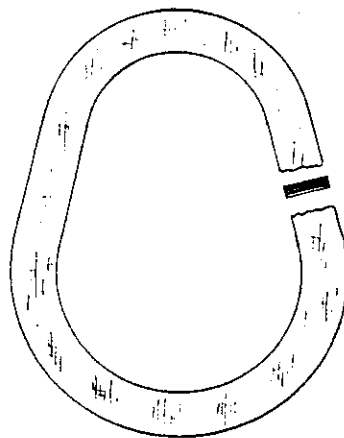

Routed Heavy Plywood

Figure 4-28. Typical frames.

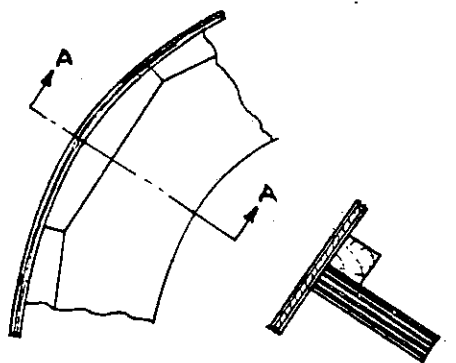

Section A-A

Figure 4-29. Use of glue blocks with routed plywood bulkhead.

4.6. Glue Joints

4.60. GENERAL. Glue joints should be used for all attachments of wood to wood unless concentrated loads, cleavage loads, or other considerations necessitate the use of mechanical connections.

4.61. ECCENTRICITIES. Eccentricities and tension components should be avoided in glue joints by means of careful design. Figure 4-33 illustrates an example of an eccentricity and a method of avoiding it.

4.62. AVOIDANCE OF END GRAIN JOINTS. End grain glue joints will carry no appreciable load. Strength is given to such a joint by using corner blocks or gussets as shown in figure 4-34. These sketches are typical of joints encountered in joining rib members, in attaching ribs to beams or intercostals to frames, or any other similar application.

4.63. GLUING OF PLYWOOD OVER WOOD-PLYWOOD COMBINATIONS. Many secondary glue joints must be made between plywood covering and wood-plywood structural members having plywood edges appearing on the surface to be glued. Wood-plywood beams or wing ribs em-

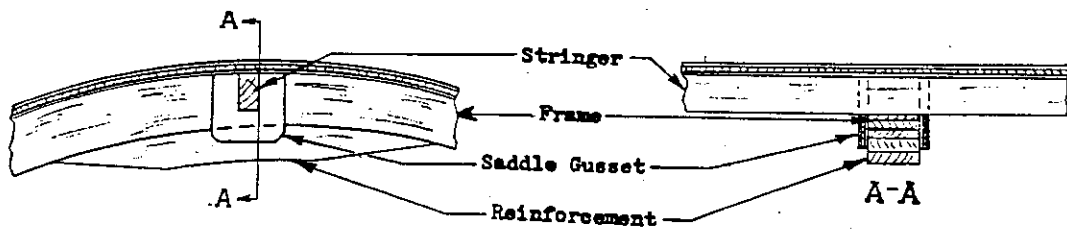

Figure 4-30. Stringer through frame joint.

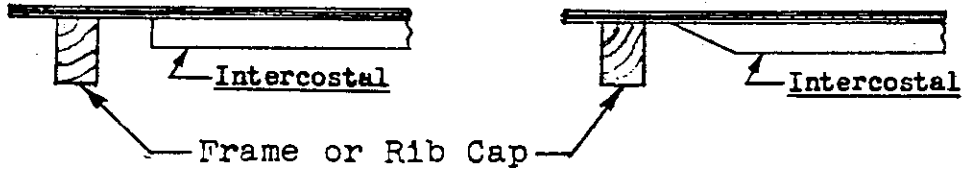

Figure 4-31. Poor method of intercostal attachment.

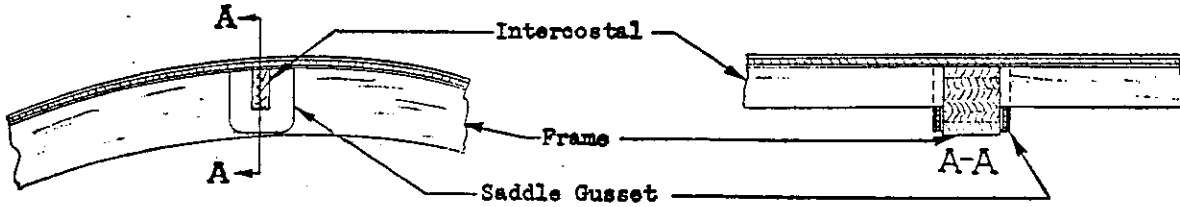

Figure 4-32. Acceptable method of intercostal attachment.

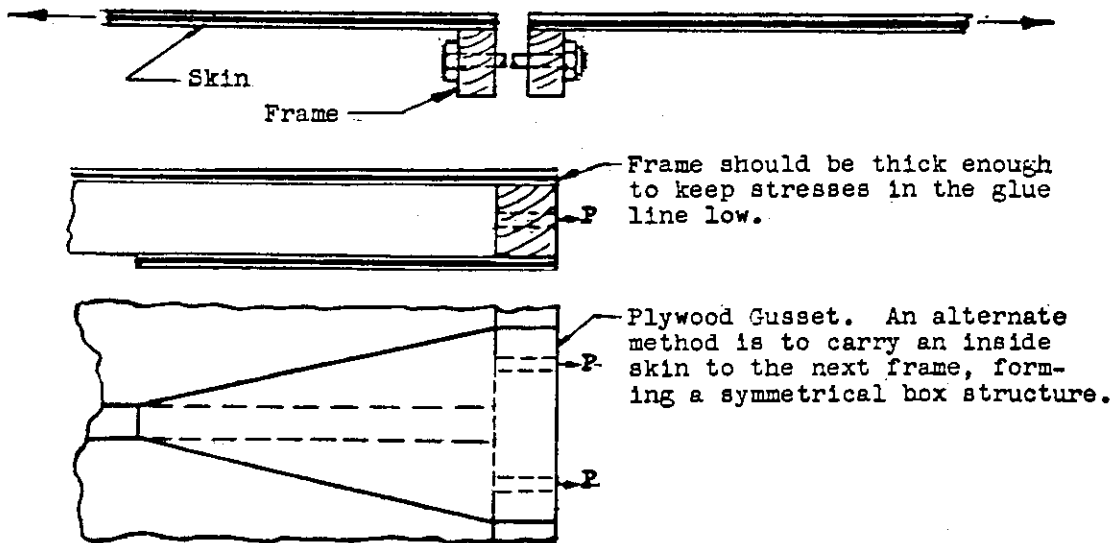

Figure 4-33. Joint in a shell structure.

plying continuous gussets are examples of such members. The plywood edge has a tendency to project above the surface thereby preventing contact between the plywood covering and the wood portion of the wood-plywood surface. This condition can be the result of differential shrinkage between the wood and plywood or may be caused by the surfacing machine having a different effect cutting across the grain of the plywood from cutting parallel to the grain of the wood. Figure 4-35 shows this condition and shows how it can

be eliminated by beveling the edges of the plywood.

4.64. GLUING OF HIGH-DENSITY MATERIAL. Better glue joints can be obtained between a high-density material and a relatively soft wood if the surface of the high-density material is sanded before gluing. The purpose of sanding is to remove the glazed surface present on high-density material and present on some plywoods. Satisfactory compreg-to-compreg joints can be made if

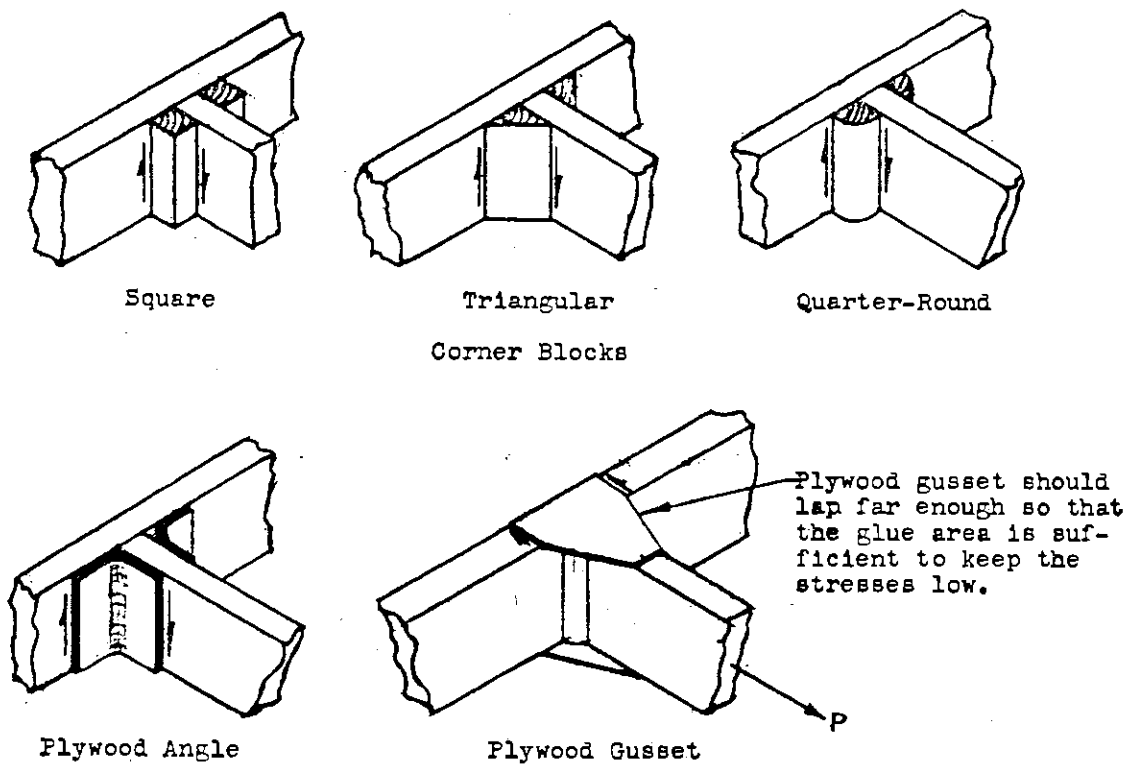

Figure 4-84. Typical reinforcement of end grain joints.

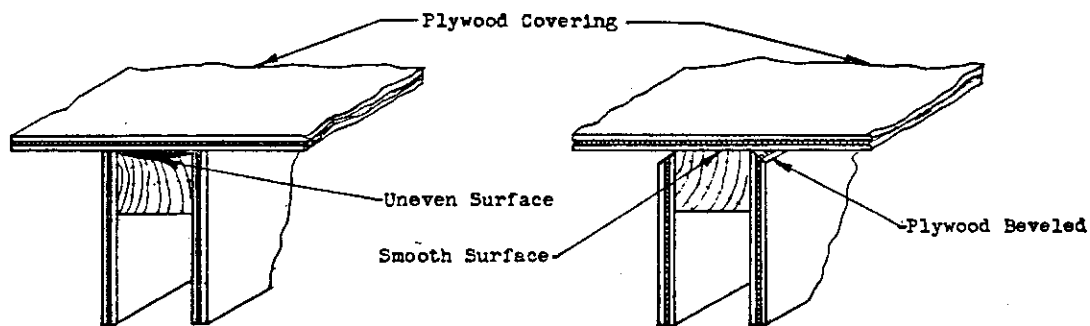

Figure 4-35. Beveling of plywood webs and gussets.

both surfaces are machined perfectly flat immediately prior to gluing.

4.7. Mechanical Joints

4.70. GENERAL. Mechanical joints in wood are usually limited to types employing aircraft bolts. Since bolts in wood can carry a much higher load parallel to the grain of the wood than across the grain, it is generally advantageous to design a fitting and its mating wood parts so that the loads on the bolts are parallel to the grain. The use of a pair of bolts on the same grain line, carrying loads perpendicular to the grain and oppositely directed, is likely to increase the tendency to split. When a long row of bolts is used to join two parts of a structure, consideration should be given to the relative deformation of the parts, as explained in section 4.82.

4.71. USE OF BUSHINGS. Bushings are often used in wood to provide additional bearing area and to prevent crushing of the wood when bolts are tightened (fig. 4-36). When bolts of large L/D (length/diameter) ratio are used, or when bolts are used through a member having high-density plates on the faces, plug bushings may be used to advantage.

4.72. USE OF HIGH-DENSITY MATERIAL. Whenever highly concentrated loads are introduced, greater bearing strength can be obtained by scarfing-in high-density material (sec. 4.63). Some high density materials are quite sensitive to stress concentrations and the possibility of the serious effects of such stress concentrations should be considered when large loads must be carried through the high-density material.

Wherever metal fittings are attached to wood

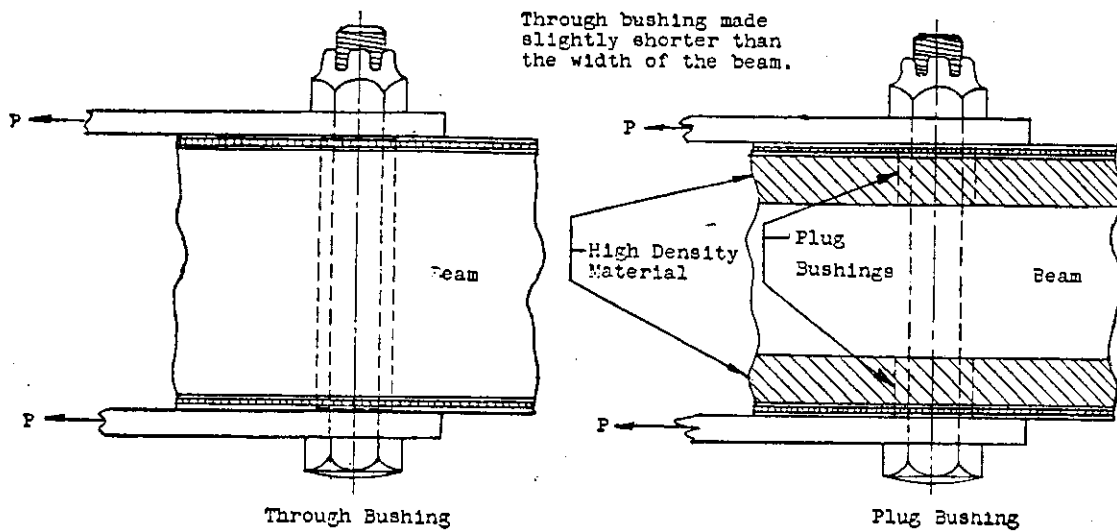

Figure 4-36. Types of bushings.

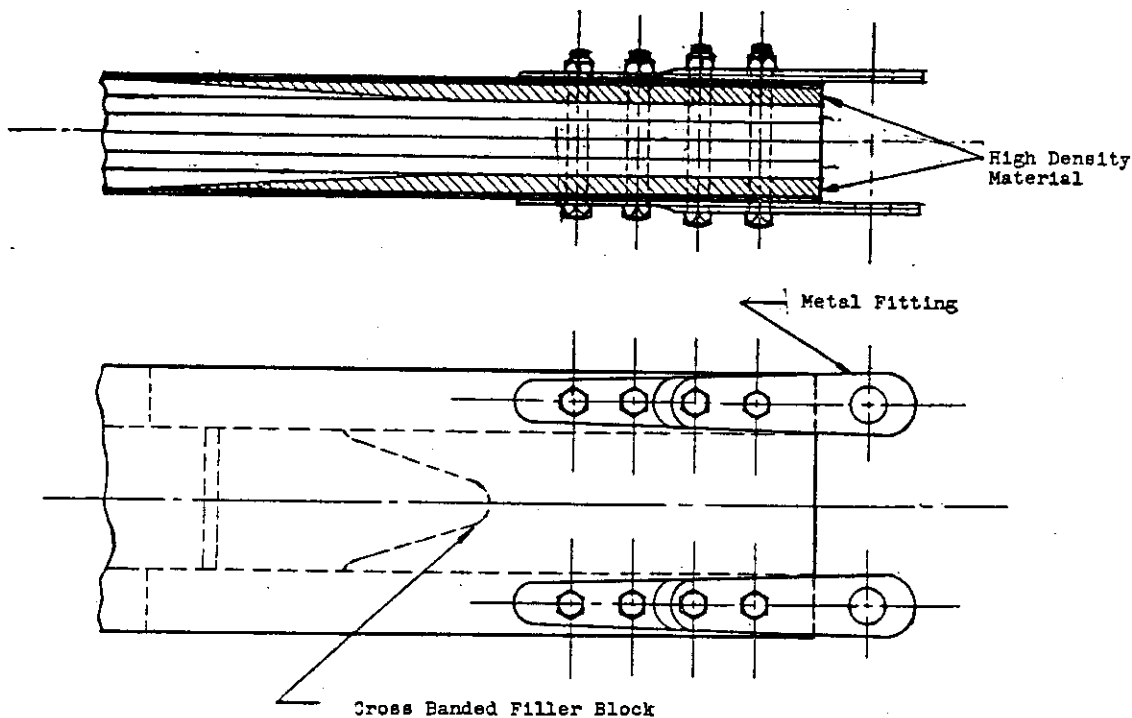

Figure 4-37. Typical wing beam attachment.

members, it is generally advisable to reinforce the wood against crushing by the use of high-density bearing plates (fig. 4-37), and to use a coat of bitumastic or similar material between the wood and metal to guard against corrosion. Cross banding of these plates will help to prevent splitting of the solid wood member.

4.73. MECHANICAL ATTACHMENT OF RIBS. When ribs carry heavy or concentrated loads it is sometimes desirable to insure their attachment by use of mechanical fastenings (fig. 4-39).

4.74. ATTACHMENT OF VARIOUS TYPES OF FITTINGS. Fittings should have wide base plates to prevent crushing at edges. Wood washers have a

tendency to cone under tightening loads. Where possible, it is desirable to use washer plates for bolt groups, as illustrated in figure 4-40, but if washers are used, a special type for wood, AN-970 or equivalent, are necessary to provide sufficient bearing area.

Clamps around wood members should be constructed so that they can be tightened symmetrically (fig. 4-41).

4.75. USE OF WOOD SCREWS, RIVETS, NAILS, AND SELF-LOCKING NUTS. Wood screws and rivets are sometimes used for the attachment of secondary structure but should not be used in connecting primary members. Wood screws have

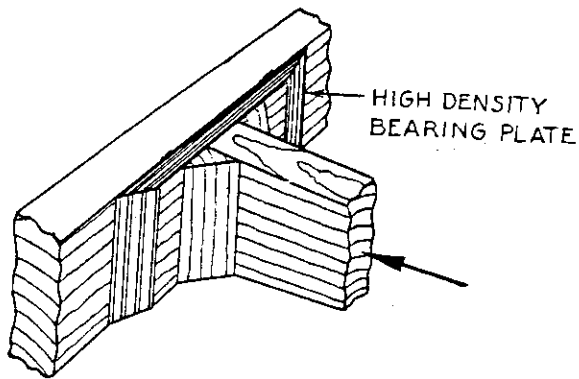

Figure 4-38. Distribution of crushing loads.

been successfully used to prevent cleavage of plywood skin from stringers in some skin-stringer applications. Nails should never be used in aircraft to carry structural loads.

Self-locking nuts of approved types designed for use with wood and plywood structures are preferable to plate or anchor nuts. When the latter type is used, however, attachment may be made to the structure with wood screws or rivets provided that care is taken not to reduce the strength

of load-carrying members. Riveting through wood is always questionable because of the danger of crushing the wood under the rivet heads and the possibility of bending the shank while bucking the rivet. Also, there is no way of tightening the joint when dimensional changes from shrinkage occur.

4.8. Miscellaneous Design Details

4.80. METAL TO WOOD CONNECTIONS. Metal to wood connections are complicated by an inherent weakness of all untreated wood—low shear and bearing strength. Sections 4.6 and 4.7 present various methods of minimizing this drawback.

Another way of improving the efficiency of wood structures is to keep the number of joints to a minimum. For example, when other design considerations will permit, a one-piece wood wing is desirable; when this is not permissible, the wing joint should be placed as far outboard as possible so that the fitting loads will be low.

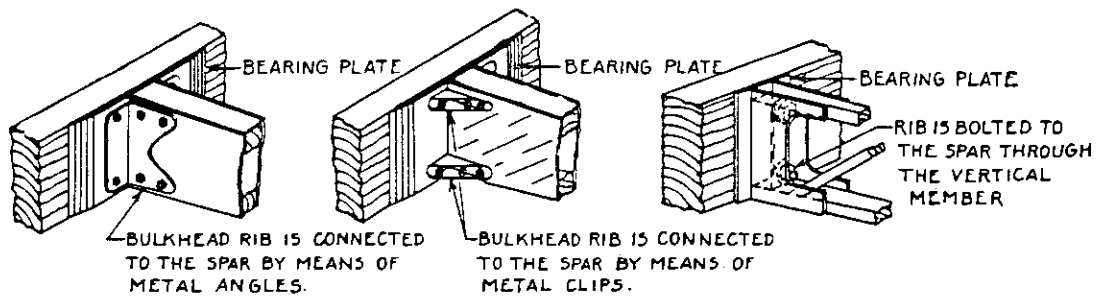

Figure 4-39. Mechanical attachment of ribs.

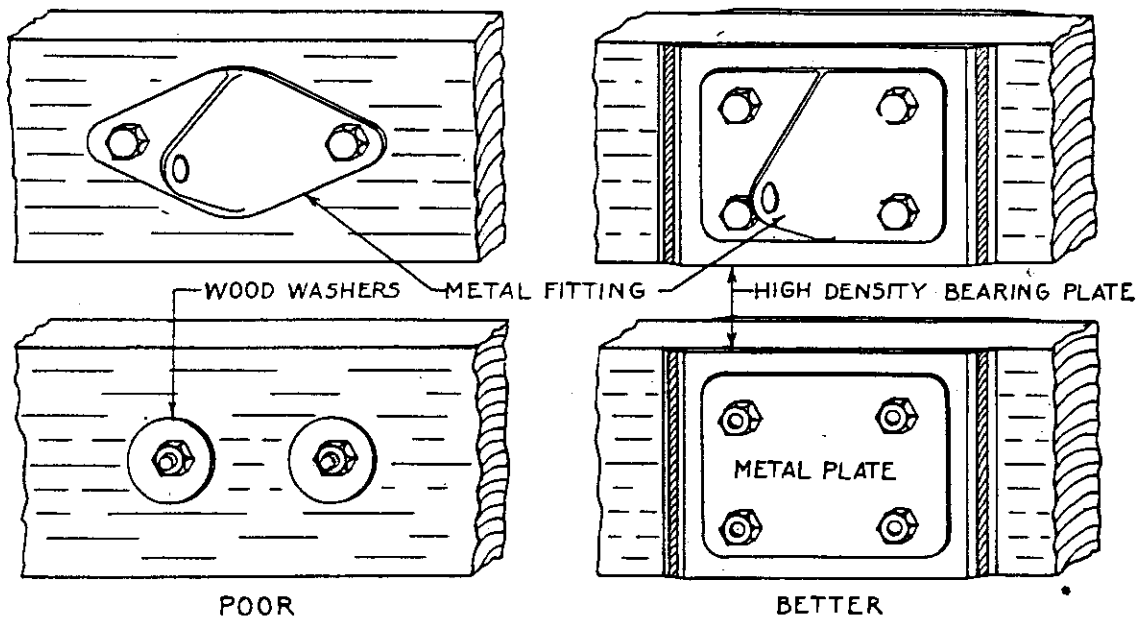
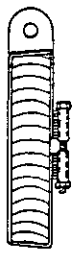
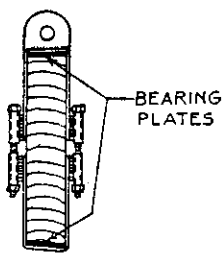

Figure 4-40. Example of control surface hinge fitting attachment.



POOR



BETTER

Figure 4-41. Installation of clamp fittings.

4.81. STRESS CONCENTRATIONS. Since wood in tension has practically no elongation between the proportional limit and the ultimate strength, there is little of the "internal adjustment" common to metal structures. Stress concentrations, therefore, become more critical and, for efficient design, must be held to a minimum. The fact that compreg and similar materials are very sensitive to stress concentrations should be carefully considered when these materials are used.

4.82. BEHAVIOR OF DISSIMILAR MATERIALS WORKING TOGETHER. When materials of differing rigidities, such as normal wood, compreg, or metal fittings, are fastened together for a considerable distance and are under high stress, consideration should be given to the fact that the fastening causes the total deformation of all materials to be the same. A typical example is a long metal strap bolted to a wood spar flange for the purpose of taking the load out of the wood at a wing joint. In order that the load be uniformly distributed among the bolts, the ratio of the stress to the modulus of elasticity should be the same for both materials at every point. This may be approximated in practical structures by tapering the straps and the wood in such a manner that the average stress in each (over the length of the fastening) divided by its modulus of elasticity gives the same ratio.

When splicing high-density materials to wood, or in dropping off bearing plates, the slope of the scarf should be less steep than the slope allowed for normal wood.

4.83. EFFECTS OF SHRINKAGE. When the moisture content of a piece of wood is lowered its dimensions decrease. The dimensional change is greatest in a tangential direction (across the fibers and parallel to the growth rings), somewhat less in a radial direction (across the fibers and perpendicular to the growth rings), and is negligible in a longitudinal direction (parallel to the fibers). For this reason a flat-grained board will have a greater

change in width for a given moisture content change than an edge-grained board. Flat-grained boards also have a greater tendency to warp than do edge-grained boards.

These dimensional changes can have several deleterious effects upon a wood structure and the designer must study each case to determine which effects are most harmful, and which are the most satisfactory methods of minimizing them. Loosening of fittings and wire bracing are common results of shrinkage. Checking or splitting of wood members frequently occurs when shrinkage takes place in members that are restrained against dimensional change. Restraint is sometimes given by metal fittings and quite often by plywood reinforcements since plywood shrinkage is roughly only 1/20 of cross grain shrinkage of solid wood.

A few of the methods of minimizing these shrinkage effects are:

1. Use bushings that are slightly short so that when the wood member shrinks the bushings do not protrude and the fittings may be tightened firmly against the member (fig. 4-36).
2. Place the wood so that the more important face, in regard to maintaining dimension, is edge-grained. For example, solid spars are required to be edge-grained on their vertical face so that the change in depth is a minimum.
3. Wood members can be reinforced against checking or splitting by means of plywood inserts or cross bolts (fig. 4-42). Care should be taken to avoid constructions that introduce cleavage (cross-grain) loads when shrinkage occurs.
4. Plywood face plates should be dropped off gradually either by feathering or by shaping so that the cleavage loads at the edge of the plywood are minimized when shrinkage occurs (fig. 4-43).

4.84. DRAINAGE AND VENTILATION. Wood structures must be adequately drained to insure a normal length of service life. This applies to box spar sections as well as all low portions of wings and fuselages. The usual method is to drain each compartment separately as illustrated in figure 4-44. Another acceptable method is to drain from one compartment to another until the lowest compartment is reached, or structural requirements prohibit further internal drainage, before drainage holes to the exterior are bored. This method is illustrated in figure 4-45.

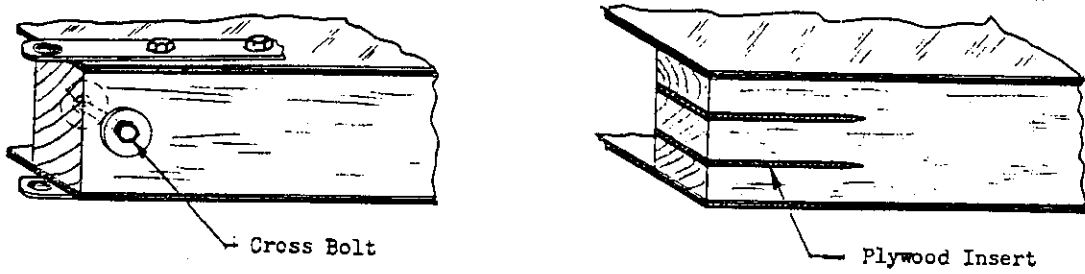

Figure 4-42. Protection against splitting.

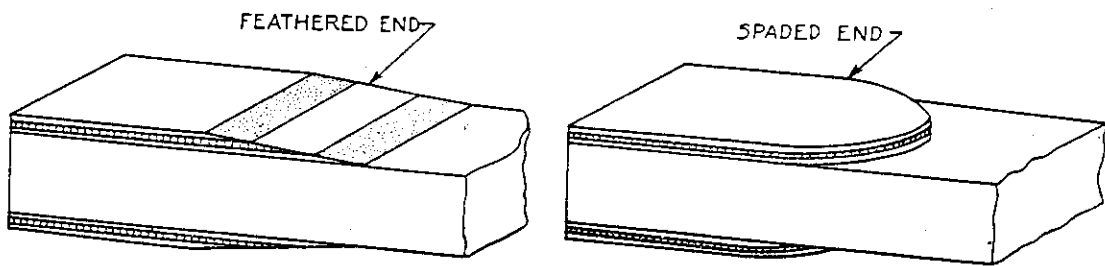

Figure 4-43. Tapering of face plates.

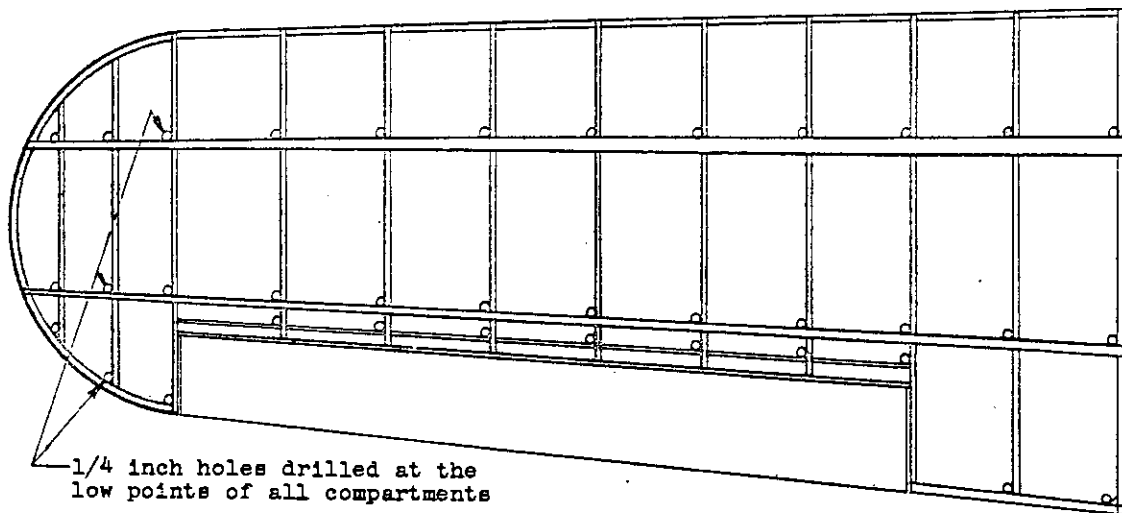

Figure 4-44. Drainage diagram of wing, direct method.

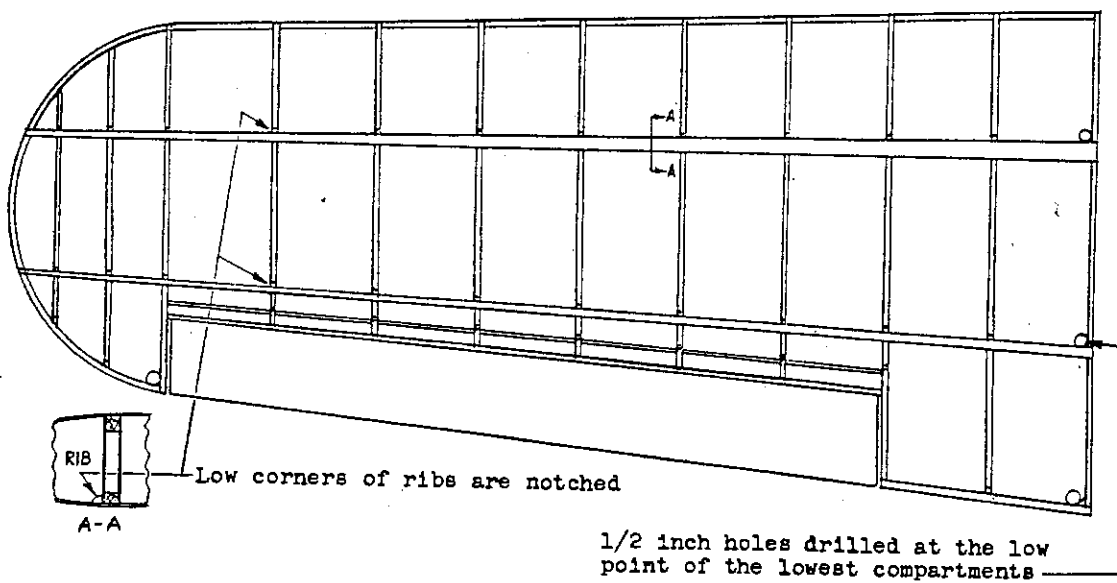

Figure 4-45. Drainage diagram of wing, internal method.

Service experience indicates that drainage holes for individual compartments should be not less than one-quarter inch in diameter, with three-eighths inch being preferable. Drainage holes to the exterior used with the internal drainage system should probably be somewhat larger. If the internal drainage system is used it is suggested that the inter-compartment drainage holes be inspected after the internal finish has been applied to make sure that the finish has not clogged the internal drain holes. This will necessitate attaching the top skin last.

Drain holes are usually drilled from the external surface so that the splintering does not mar the external finish. After drilling drain holes, all splinters should be carefully removed from the inner surface, and the edges of the holes should be sanded lightly and protected by the application of several coats of spar varnish. It is common practice, in order to avoid damage to structural members by the drill, to drill drainage holes an appreciable distance from the low corner of a compartment. This practice must be avoided and some method of insuring proper location of drain holes at the *actual* low points must be developed by the aircraft manufacturer that will not only prevent damage to the framework but will also provide complete drainage of the structure.

It is, therefore, recommended that proof of the adequacy of the drainage system chosen be demonstrated by setting up the structure, with the top cover removed, in a position corresponding to its attitude when the airplane is resting on the ground. Water is then poured into the structure and the actual performance of the drainage system observed.

Careful design to prevent entry of water into the structure is equally important. Careful location of all openings and use of boots and gaskets should be considered. If interiors do happen to get wet, good ventilation will accelerate the drying. Marine grommets have been suggested for use with external drain holes in wing, tail, and control surfaces. This type of grommet produces a suction or scavenging action in flight and also protects the holes themselves from direct splash during taxiing on wet or muddy fields. Periodic inspection and cleaning of drainage holes covered with marine grommets, however, may be difficult.

4.85. INTERNAL FINISHING. It is recognized that applying finish to the inner surfaces of the

closing panels of plywood-covered structures is a difficult problem. The usual method, other than dipping, is to mask off the locations of secondary glue areas prior to the application of finish to the surface, for wood coated with a protective finish cannot be glued. This is a time-consuming operation, and after the plywood covering is finally fitted into place, the film of finish usually stops short of the intersection lines between the plywood covering and framework. These are the very places where the finish is needed most if water does accumulate in the interior.

Wood-rotting organisms can act only if the moisture content of the wood is above approximately 20 to 25 percent. Although finishes will not prevent moisture content changes in wood, they will retard such changes so that the wood moisture content will not follow the rapid changes in atmospheric conditions but only the more gradual changes. Therefore, if wood members are finished, dangerously high moisture contents will be reached in wood aircraft structures only when parts are in contact with standing water since atmospheric conditions that produce high moisture contents are generally of relatively short duration, except in extreme climates such as the tropics, and the retarding effect of the finish may be expected to prevent the wood from attaining a high moisture content within this short period.

In view of the foregoing discussion, it is suggested that consideration be given to the following method of finishing the inner surfaces of plywood-covered assemblies. Since any free water would be in contact with the lower skin almost entirely, the lower wing covering and control surface coverings should be attached to the framework prior to the upper covering. In this way, finish can be applied thoroughly to the lower covering and adjacent framework quite easily after the assembly gluing operation has been completed. Since gaps in the finish on the upper covering along framework members are not so harmful as they would be on the inner surfaces of the lower covering, wider masking strips may be used over secondary glue areas on the upper covering at the time of applying the internal finish, thereby reducing the chance of finished surfaces falling over framework members. Some method of accurately registering the covering should be used.

4.86. EXTERNAL FINISHING. Two types of external finish for plywood covered aircraft have been used successfully, the direct-to-plywood finish and the fabric-covered plywood finish. There

is little difference in weight between the two systems because the weight of the fabric is offset by the difference in weight between the finishes used in the two systems.

Direct-to-plywood finishes have a tendency to check wherever a glue joint appears on the surface. Checking of the finish is also apt to occur when the grain of the wood tends to raise, as in those softwoods having appreciable contrast between spring and summerwood, such as Douglas-fir. Fabric-covered finishes do not check from these causes.

Light airplane fabric of the type specified in AN-C-83 is the usual material used for the fabric-covered plywood finish system. The fabric provides a better protection from the abrasive action of stones, sand, and other objects kicked up while taxiing than does the direct-to-plywood finish.

Observation of wood airplanes in service has revealed that plywood or fiber plates glued over exposed end grain may act as a moisture trap rather than as a moisture barrier. Several coats of brushed-in aluminized spar varnish are believed to give a much more satisfactory protection to exposed end grain. Exposed end grain should be interpreted to include exposed feathered surfaces.

4.87. SELECTION OF SPECIES. Properties other than the usually listed strength and elastic properties should also be considered when selecting a

wood for any specific purpose. For example, birch and maple are relatively difficult to glue; yellow-poplar has lower resistance to shock than spruce; Douglas-fir is low in cleavage strength.

4.88. USE OF STANDARD PLYWOOD. From a maintenance viewpoint it is desirable to use only standard plywoods for design so that too great a variety of types will not need to be carried in stock. Table 2-9 lists many of the more common constructions. If one of these is used, the formulas in chapter 2 can be used with greater ease because many of the basic parameters and strength values are given in this table. Two-ply diagonal plywood is considered a special construction by most plywood manufacturers and has the disadvantage of tending to warp because of its unsymmetrical construction.

4.89. TESTS. Quite often, time and effort may be saved by the use of simple tests in the early stages of the design of complex joints.

4.9. Examples of Actual Design Details

On the following pages several sketches and photographs are presented to show how various manufacturers have treated details encountered in the design of wood aircraft. No effort has been made to label these sketches as either good or poor practice. They are merely presented to show what the industry has done when confronted with specific problems (figs. 4-46 through 4-63).

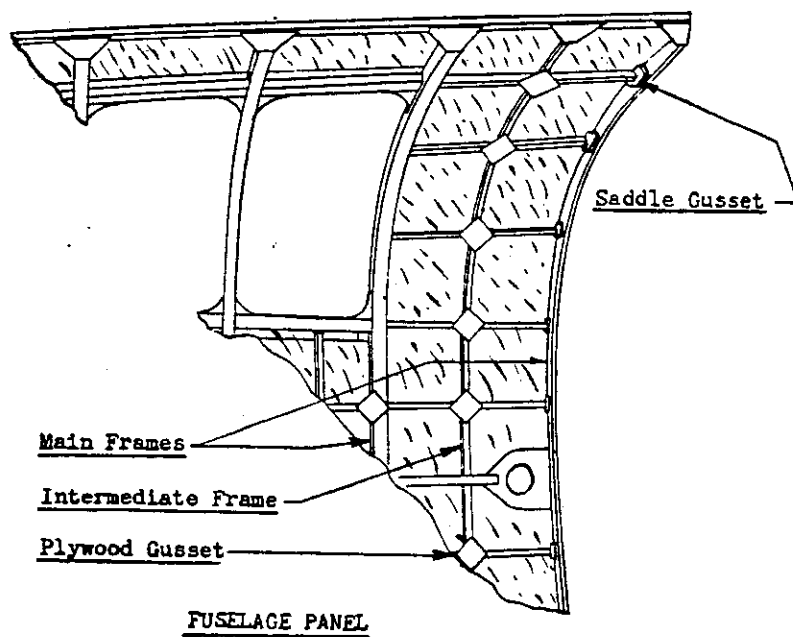

FUSELAGE PANEL

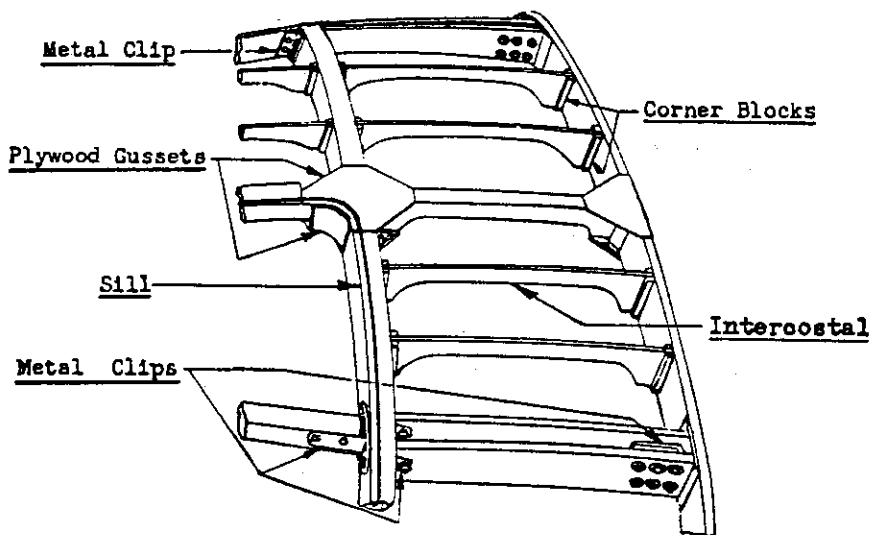

FUSELAGE NOSE SECTION

Figure 4-46. Fuselage framework.

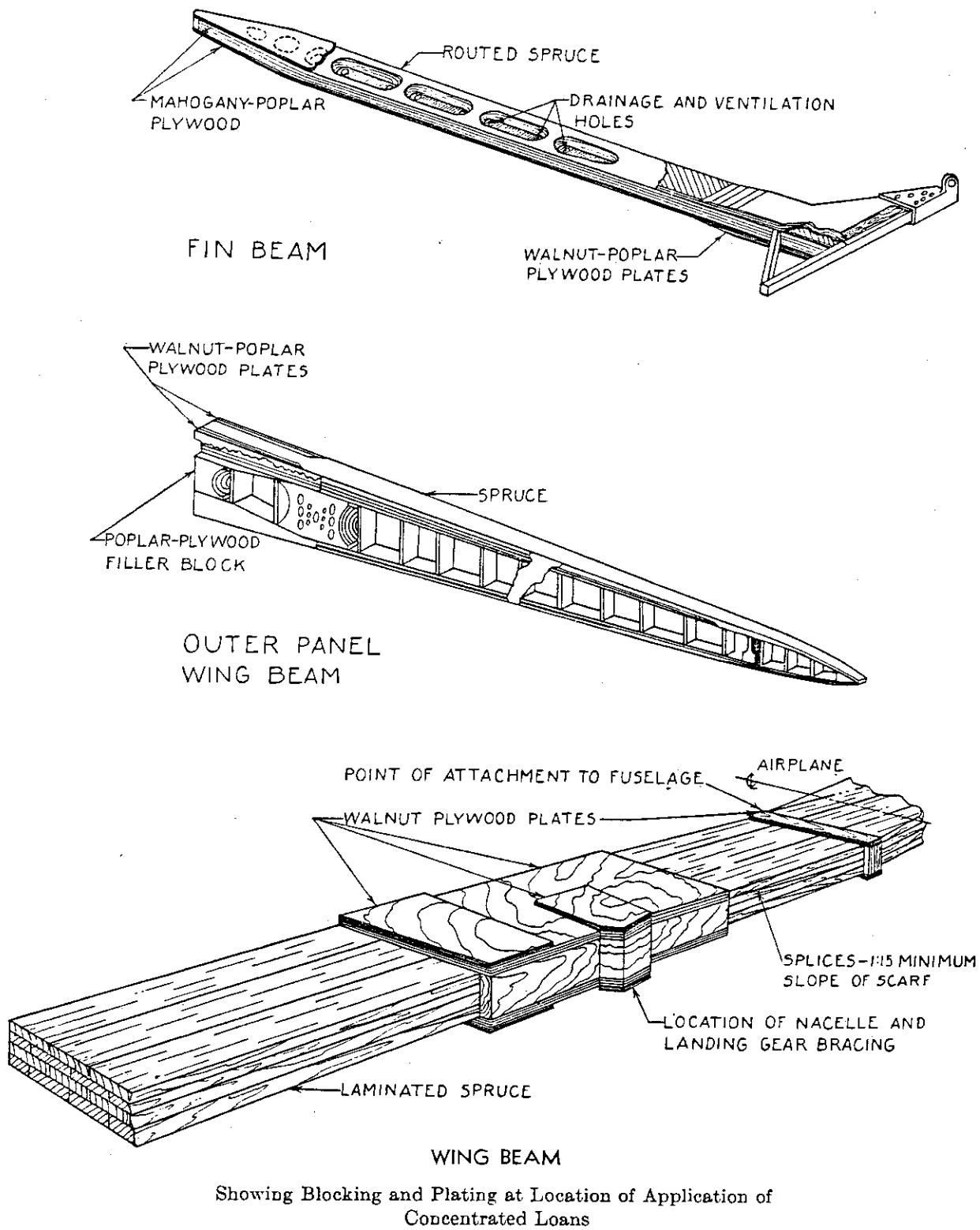
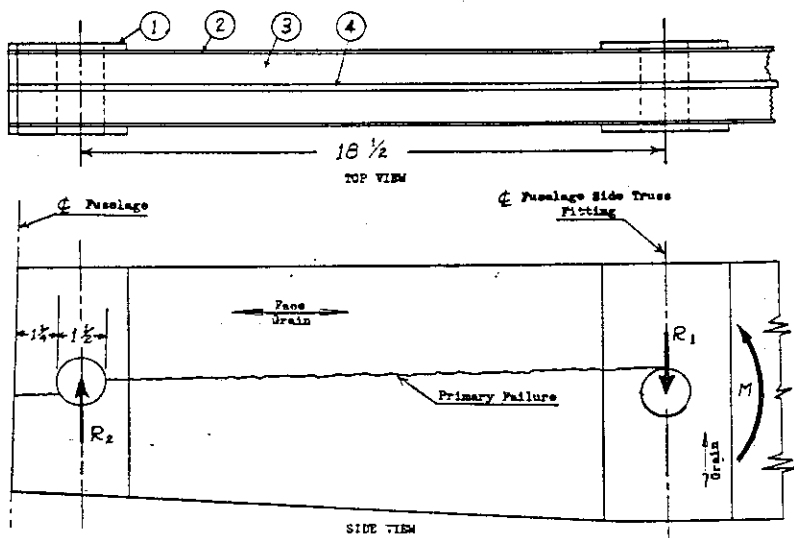
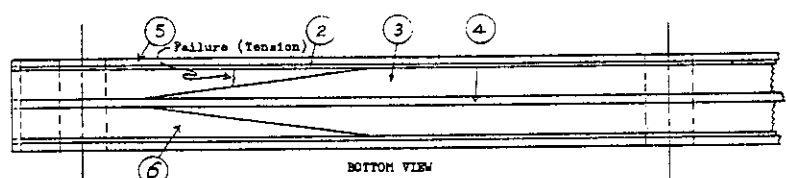

Figure 4-47. Examples of beams.



Original Design.
Failed as Indicated.
 $R_1 = 16,200$
 $R_2 = 12,200$
 $B.M. = 295,065$ in. lbs.



2nd Design.
The following changes from the original design were incorporated.
 1. Bearing blocks item 1 removed.
 2. Face plate item 5 added.
 3. End section of item 3 cutout and spruce wedges item 6 installed with grain perpendicular to the spar axis.
 Failure occurred as indicated:
 $R_1 = 10,100$ #
 $R_2 = 7600$ #
 $B.M. = 185,065$ in. lbs.

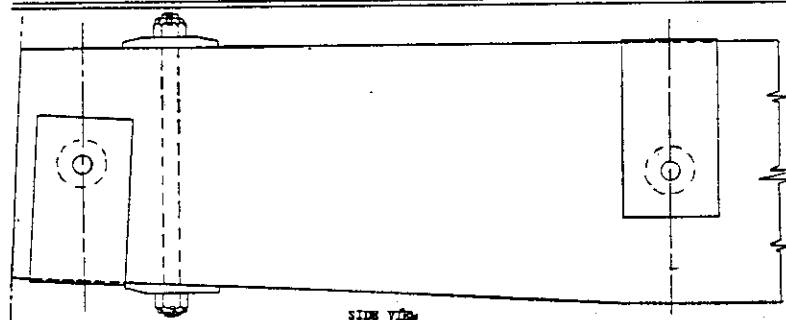

3rd Design.
The following changes from the 2nd design were incorporated.
 1. Vertical grain spruce wedges item 6 eliminated.
 2. Metal straps added.
 3. Bolt and bearing plates added.
 Loaded to:
 $R_1 = 21,400$
 $R_2 = 16,100$
 $B.M. = 387,875$ in. lbs.
 without failure.

MATERIAL NOTES	
1.	1/2" Maple
2.	1/8" - 3 Ply Mahogany
3.	1" Spruce
4.	1/2" - 45° - 4 Ply Mahogany
5.	1/2" - 4 Ply Mahogany (Face Grain Parallel to Spar Axis)
6.	Spruce - (Grain Perpendicular to Spar Axis)

Figure 4-48. Cantilever wood spar at fuselage attachment.

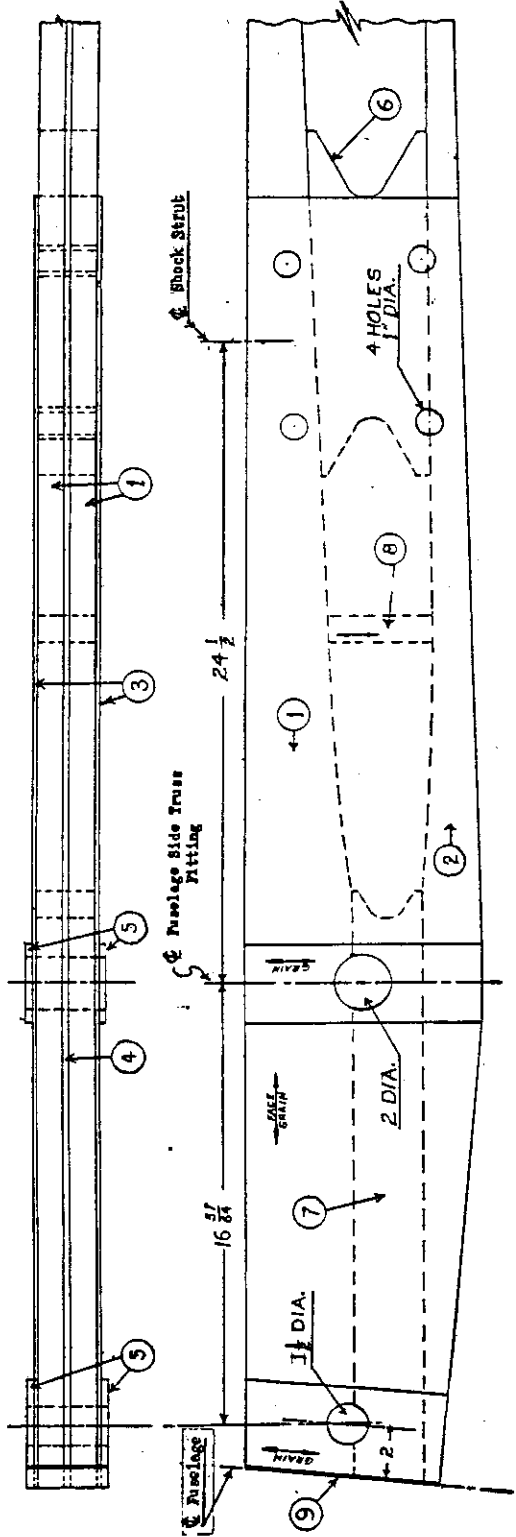

FUSELAGE ATTACHMENT

MATERIAL NOTES

- ① 1" spruce
- ② 1" spruce
- ③ 1/8"-45°-2 ply mahogany plywood
- ④ 1/4"-45°-4 ply mahogany plywood
- ⑤ 1/4"-45°-4 ply mahogany plywood
- ⑥ 1" spruce
- ⑦ 1" spruce
- ⑧ 1" spruce
- ⑨ 1/16"-5 ply mahogany plywood

LANDING GEAR ATTACHMENT

In a test for a positive flight condition the spar failed at the fuselage attachment under the following loads:

Bending Moment + 227,000 in. lbs.
 Shear + 3,750 lbs.
 Axial Load 1,500 lbs. (compression)

In a second test the spar was supported in such a manner as to insure failure at or outboard of the fuselage attachment. Failure occurred at the inner landing gear attachment bushings under the following loads:

Bending Moment + 174,158 in. lbs.
 Shear + 4,480 lbs.

Figure 4-49. Spar details for low-wing monoplane, single spar construction. Gross weight, approximately 1,300 pounds.

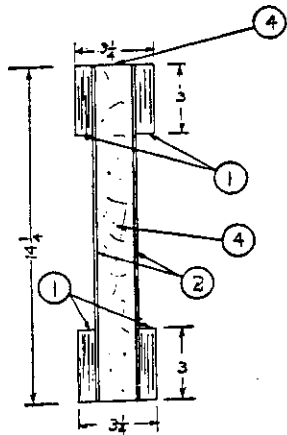
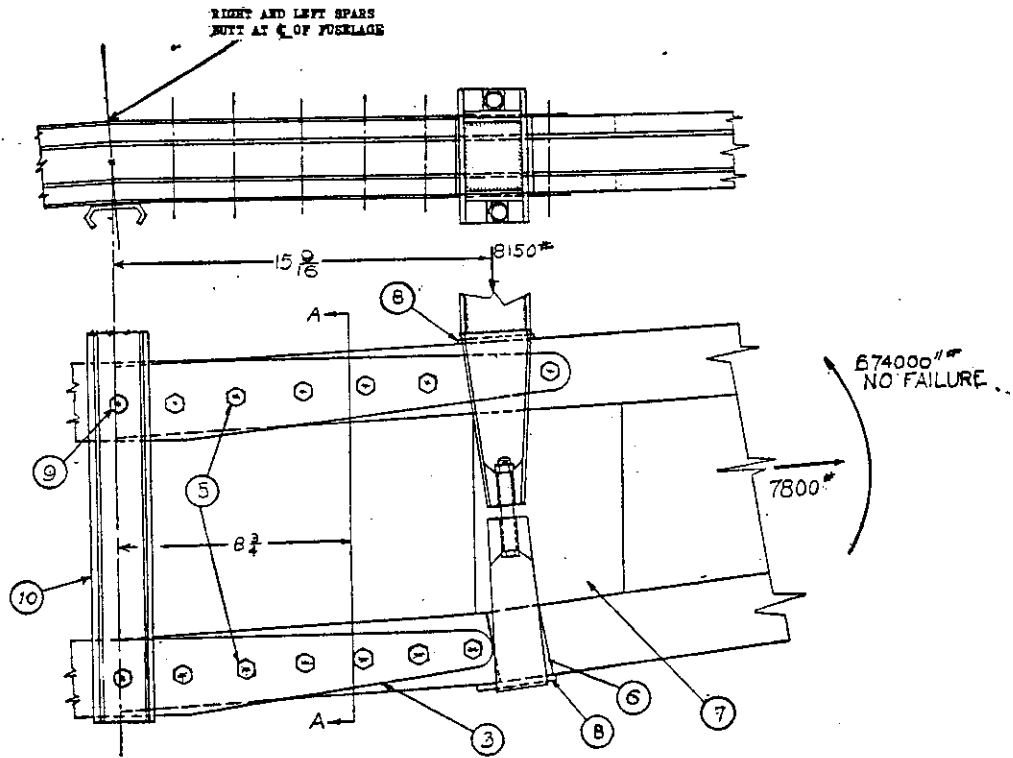

MATERIAL:

- 1 - Capstrip - 3/4" - 9 ply birch plywood (7x2)
- 2 - Shear web - 1/8" - 46° - 3 ply mahogany plywood
- 3 - Strap - .096 - 24150 - HT 160,000
- 4 - Center block - 1 1/2" - spruce
- 5 - Bolt - AN10-48
- 6 - Shim - #2 3/16x3 - spruce
- 7 - Filler block - 3/4"x6-5/32"x3"-9 ply birch plywood (7x2)
- 8 - Shim - 3/16"x2 1/2"x3 1/4"-3 ply mahogany plywood
- 9 - Center bolt - AN10-48
- 10 - Fuselage Structural Member

SECTION AA

Figure 4-50. Spar details at root section and fuselage attachment.

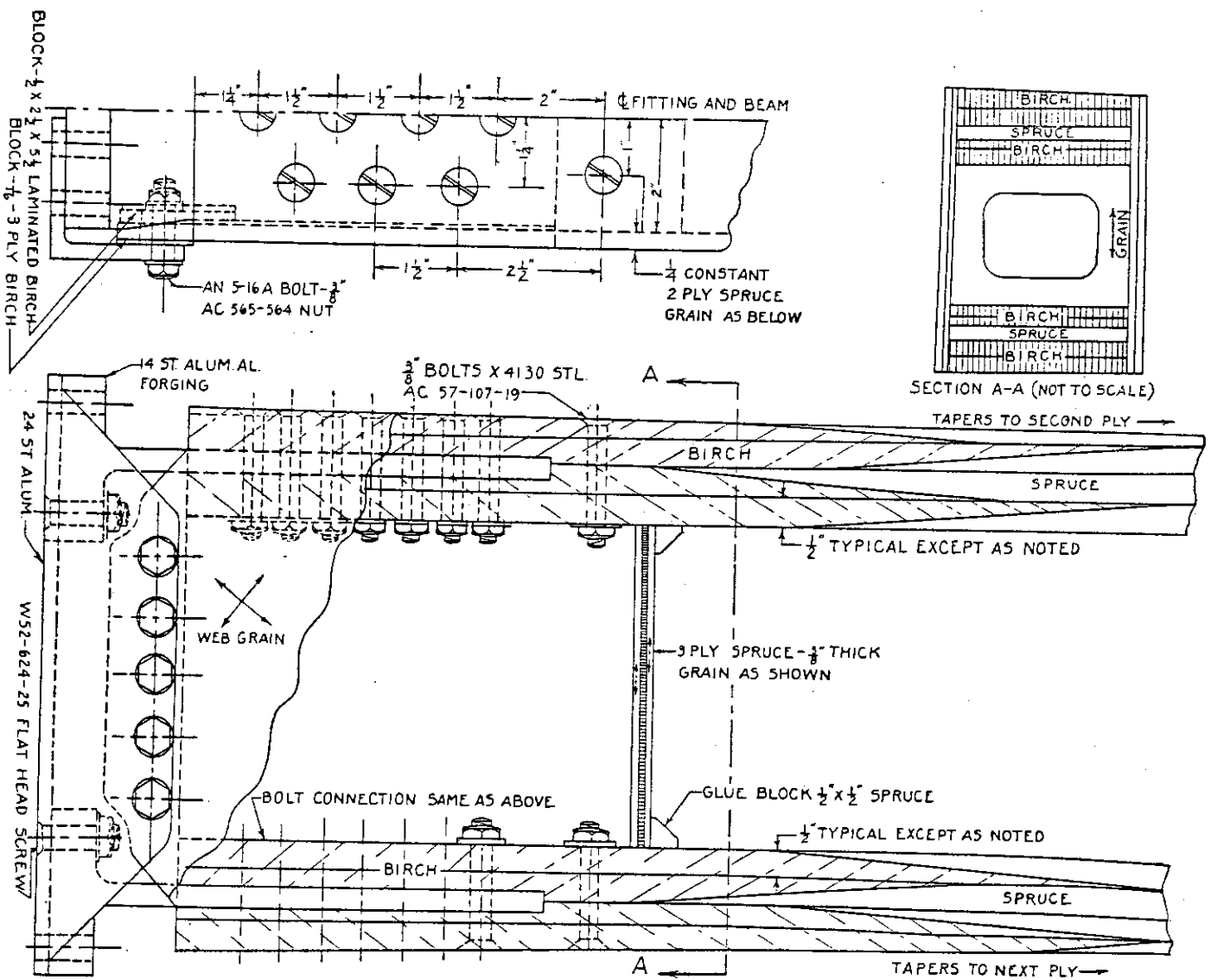

Figure 4-52. Wing beam attachment.

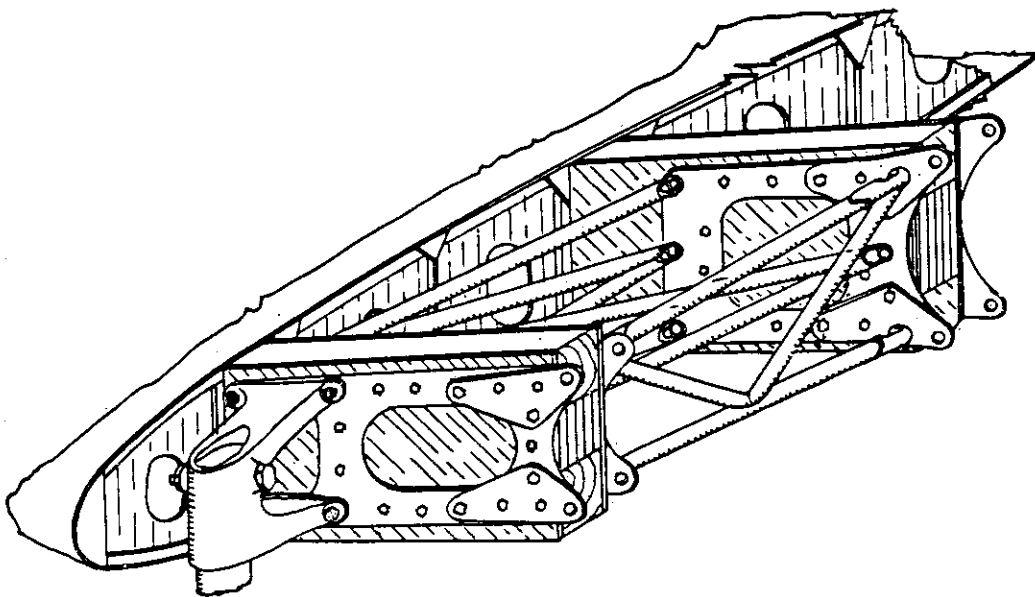

Figure 4-53. Details of landing gear attachment.

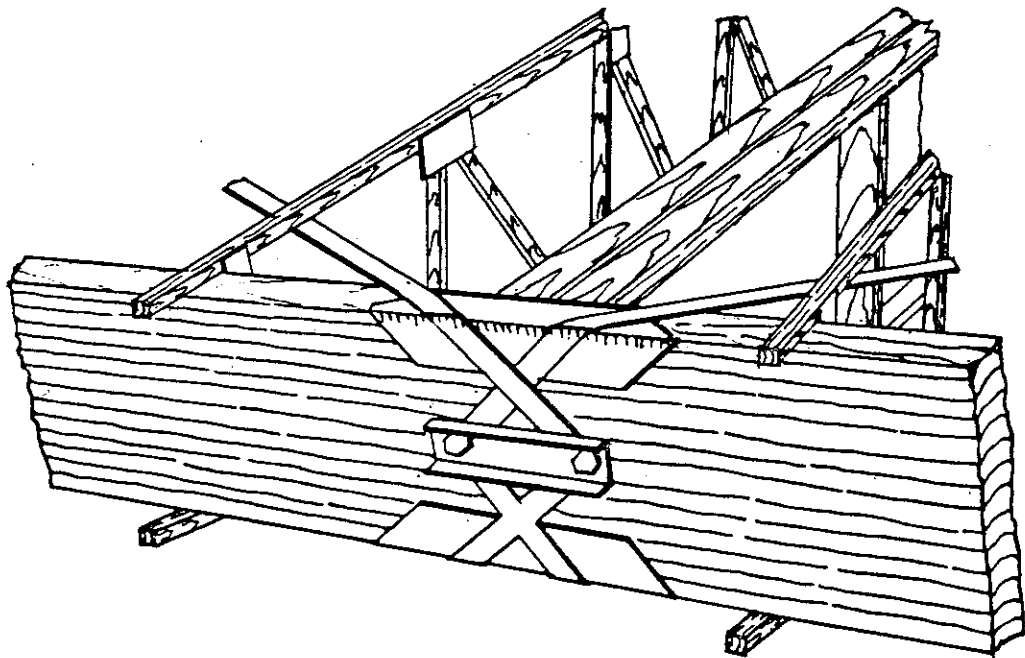

Figure 4-54. Method of double drag bracing.

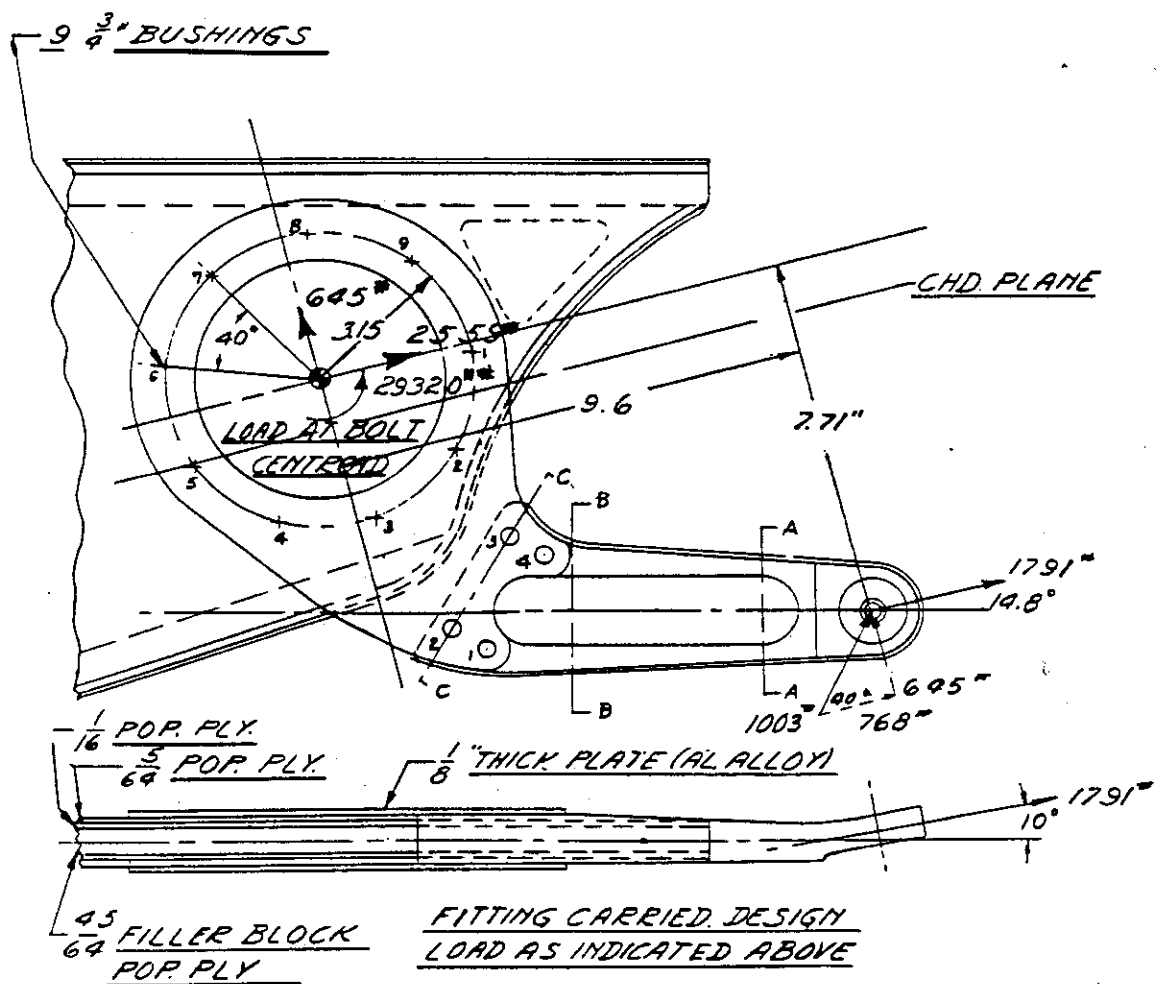

Figure 4-55. Attachment of flap hinge.

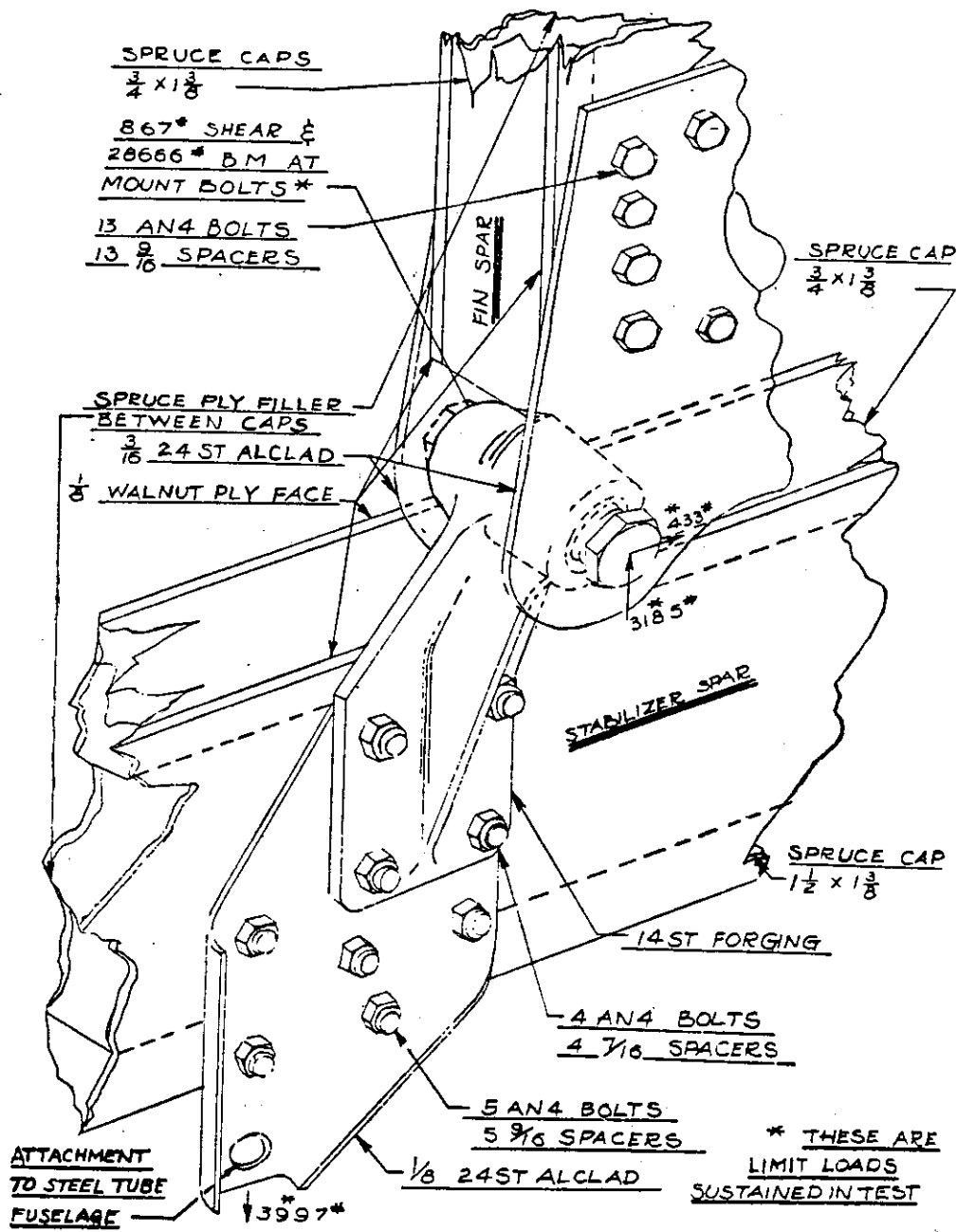

Figure 4-56. Attachment of empennage.

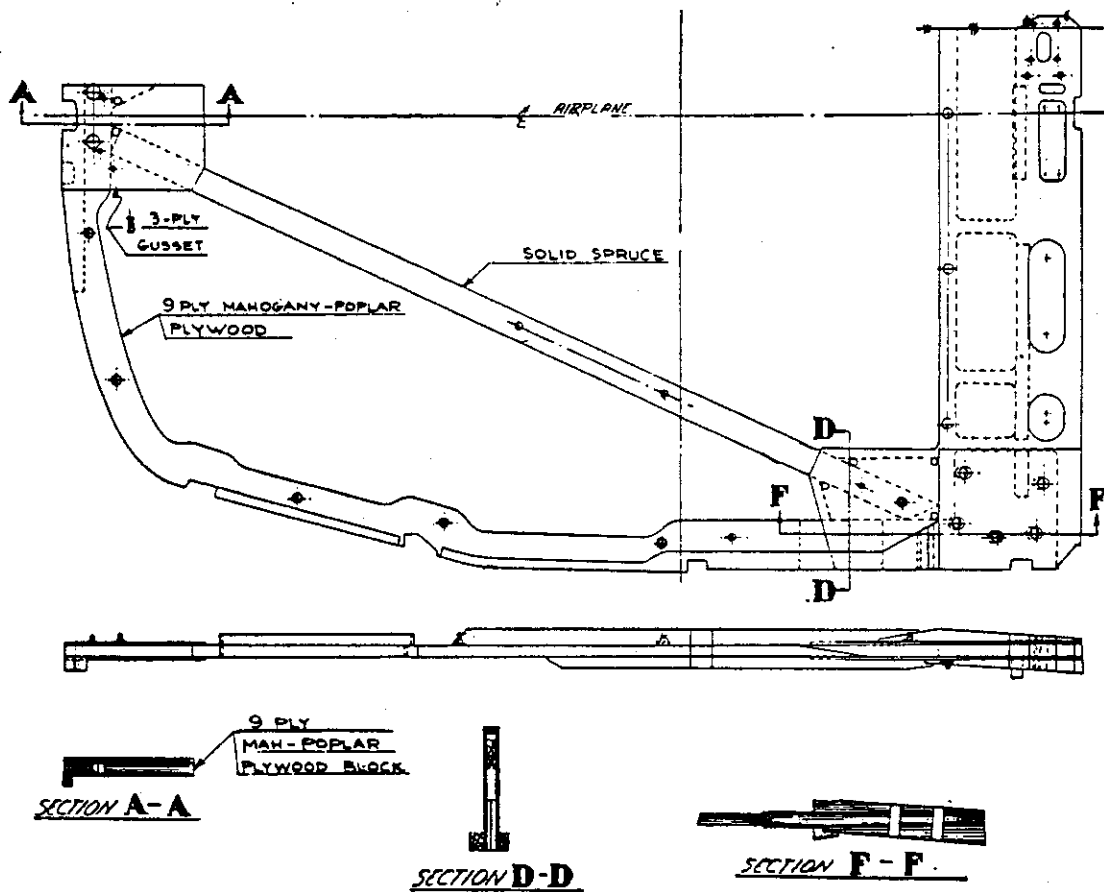

Figure 4-57. Reinforced fuselage frame.

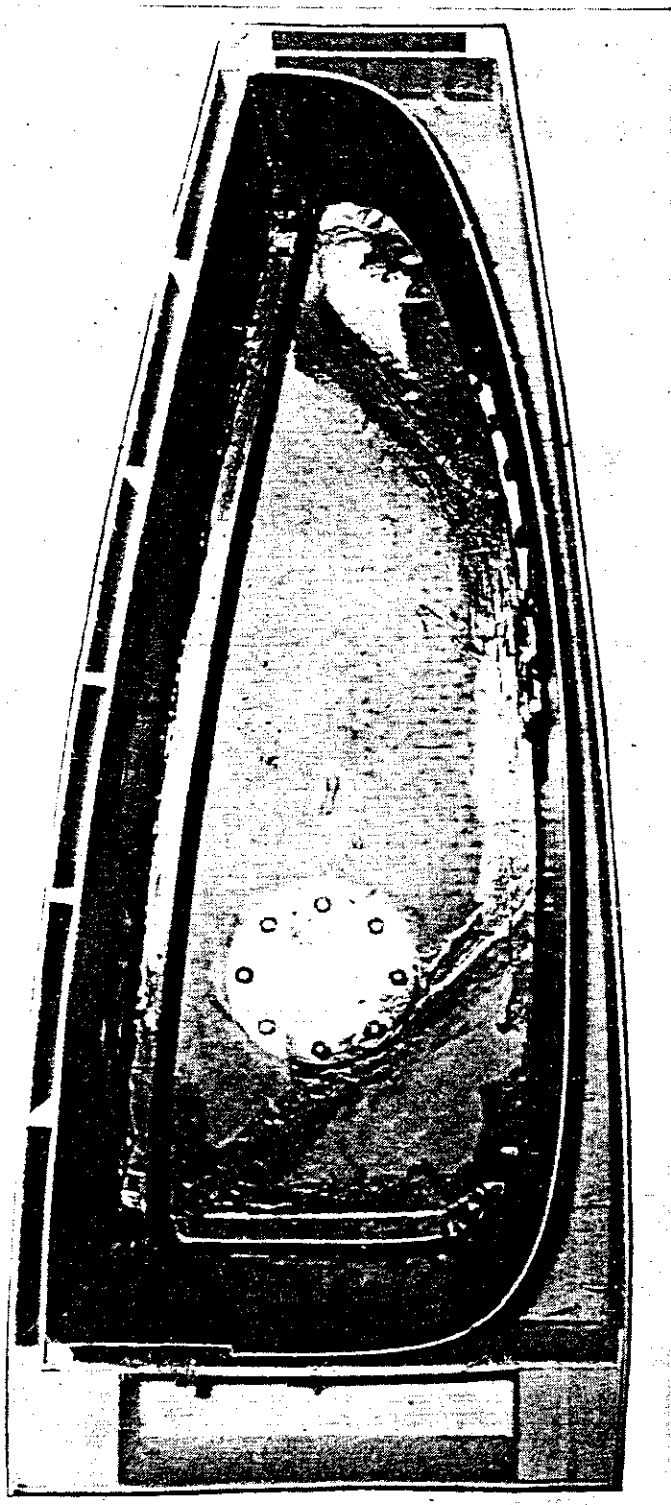

Figure 4-58. Cross section of wing showing integral fuel cell.

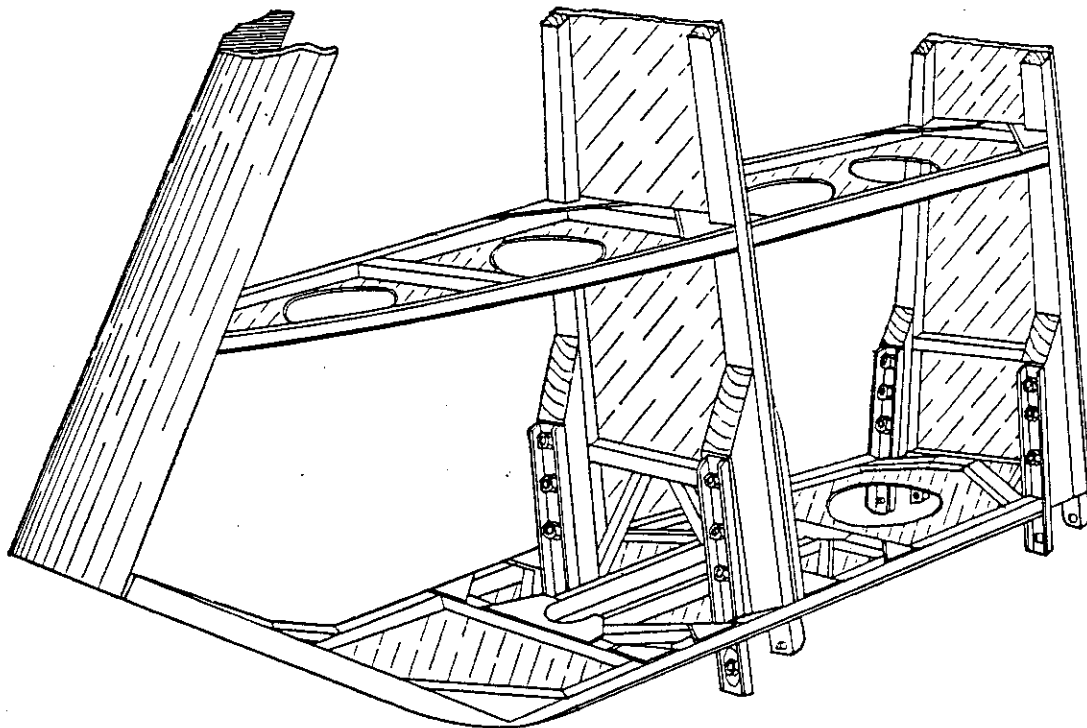

Figure 4-59. Example of wood control surface showing attachment details.

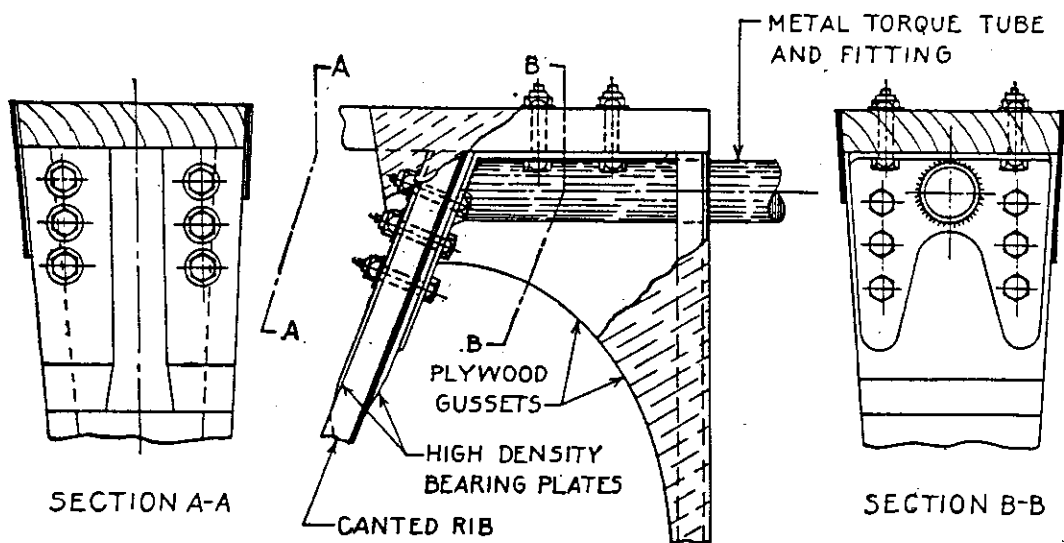

Figure 4-60. Example of elevator torque tube attachment to control surface.

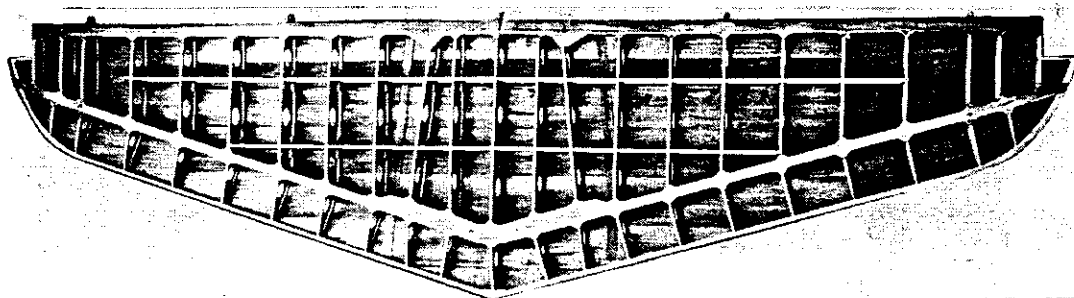

Figure 4-61. Wood stabilizer, one side of skin removed to show interior construction.

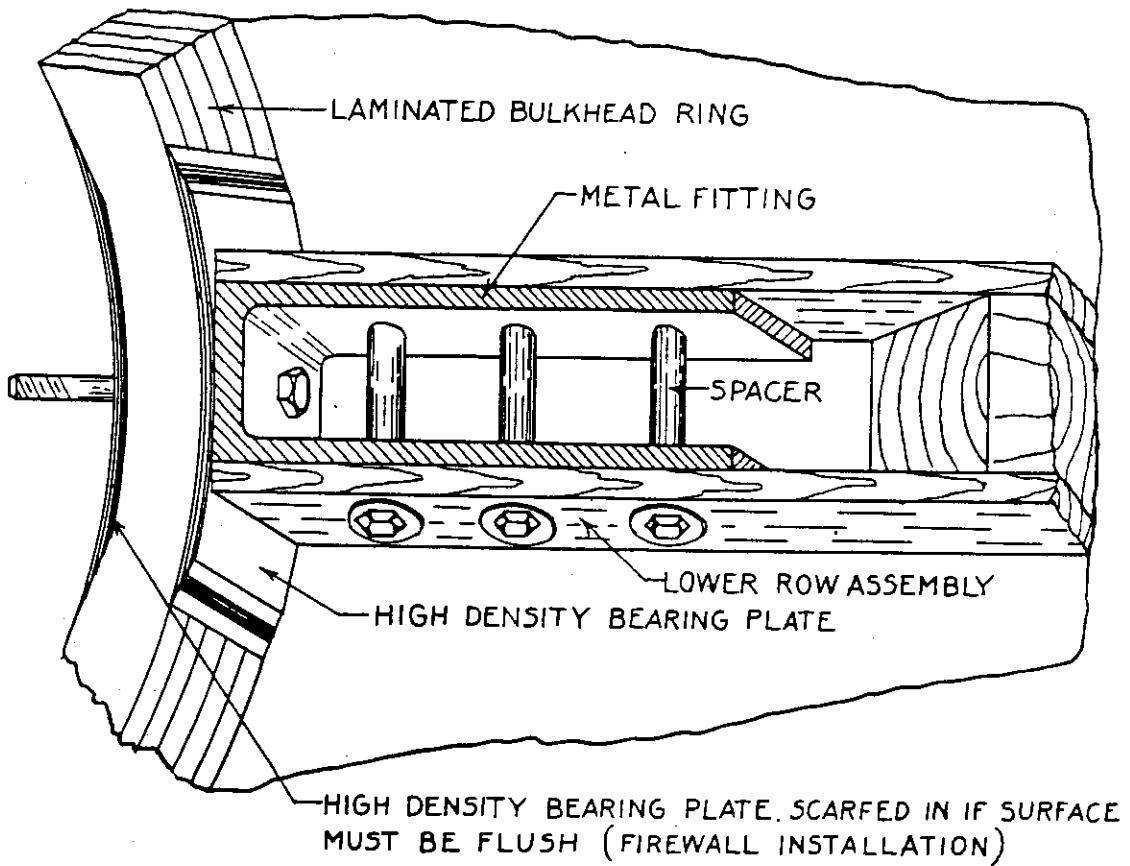
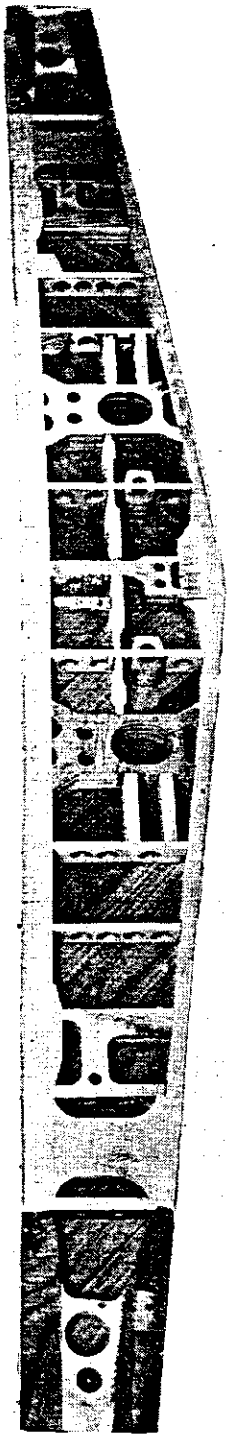
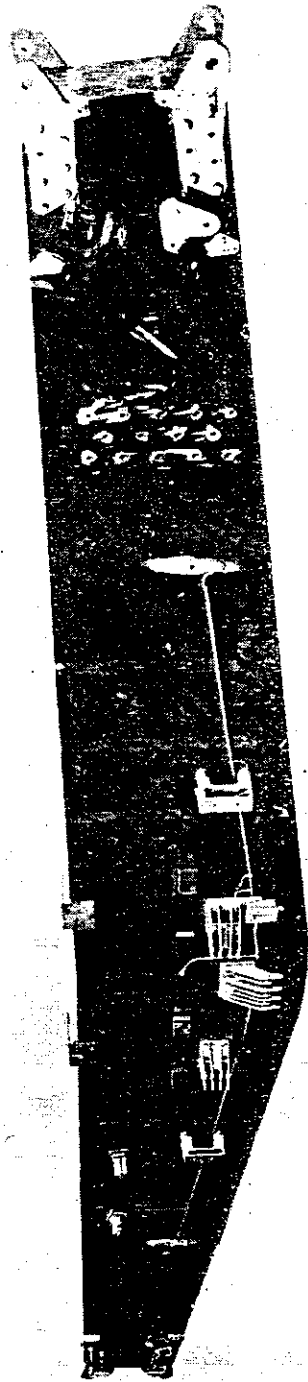

Figure 4-62. Typical fuselage joint or engine mount attachment.



CENTER SECTION BOX SPAR

FRONT WEB REMOVED TO SHOW BLOCKING



CENTER SECTION BOX SPAR SHOWING

FITTINGS

Figure 4-63. Typical main wing beam.